

Moisture meter

Operating Manual

humimeter BLL

Moisture meter with insertion probe for the determination of the moisture content of wood chips

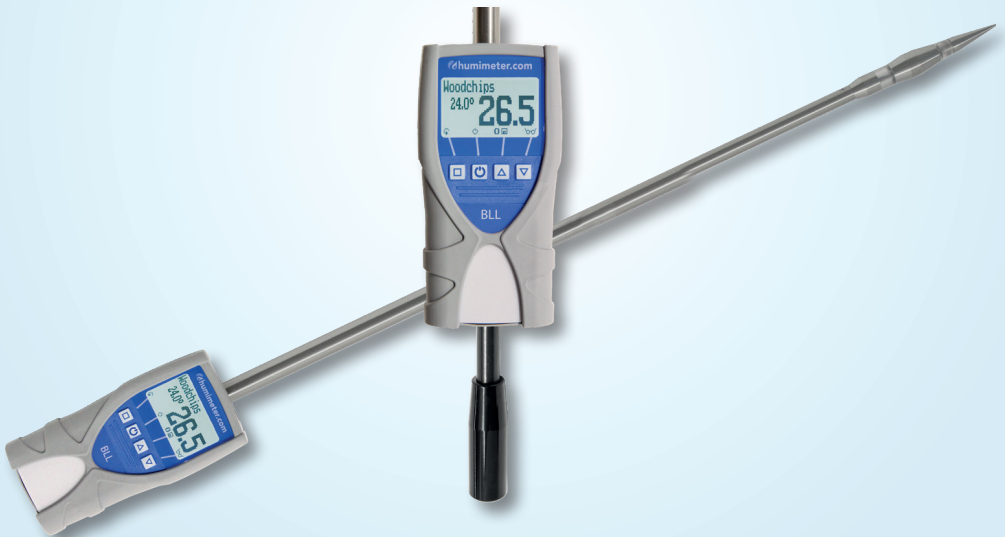

78,0 °F | 6,16% | 456kg/m³ | -27,3td | 0,64aw | 51,9%r.H. | 14,8%abs | 100,4g/m² | 09m/s | 4,90Ug/L | 1

Your humimeter BLL at a glance

The whole unit

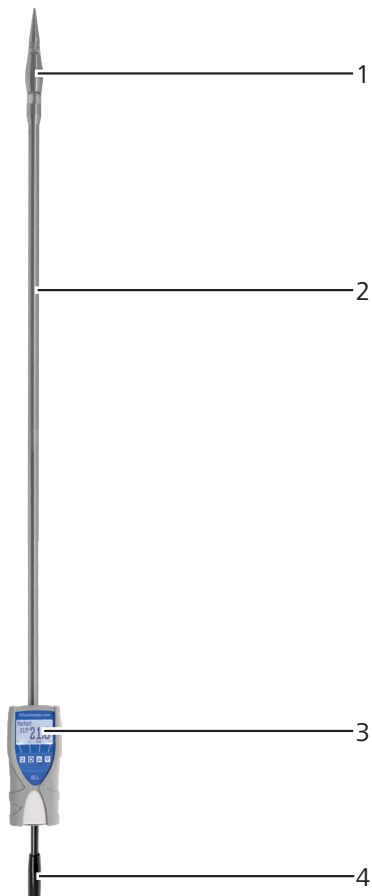

| No | Name |
|----|--------------------------------|
| 1 | Measuring head |
| 2 | Insertion probe |
| 3 | Electronics in plastic housing |
| 4 | Handle bar |

The main unit



| No | Name |
|----|-------------------------|
| 1 | USB port (optional) |
| 2 | Display |
| 3 | Keypad |
| 4 | Rubber protection cover |

Rear of the main unit

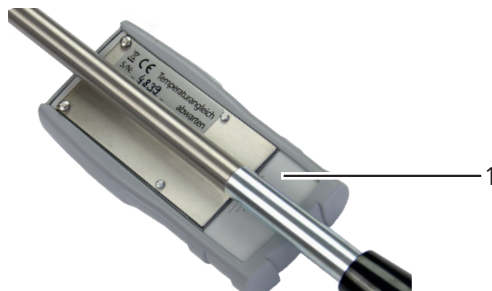

| No | Name |
|----|---------------------|
| 1 | Battery compartment |

The display

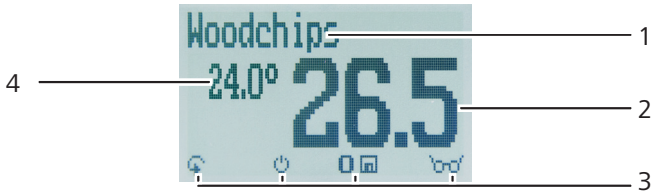

| No | Name |
|----|--|
| 1 | Calibration curve |
| 2 | Moisture content % ("6.1 How moisture content is defined") |
| 3 | Display symbols |
| 4 | Temperature display |

The display symbols

| Symbol | Name | Symbol | Name |
|--------|---------------------|--------|------------------------------|
| | Enter | | No |
| | Up | | Change input level |
| | Down | | OK |
| | Back | | Change menu |
| | Enter numbers | | Enter data |
| | Enter letters | | View measurements |
| | Continue / go right | | Delete measurements |
| | Left | | On/off button, display light |
| | Yes | | Save measured value |

The menus

The device has four different menus: Data Log, product selection, additional function and main menu:

Data Log menu

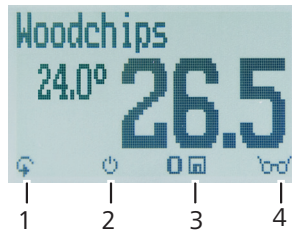

| No | Name |
|----|--------------------------------------|
| 1 | Change menu |
| 2 | Display illumination / device on/off |
| 3 | Save measured value |
| 4 | Show the last recorded values |

Product selection menu

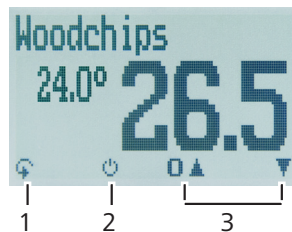

| No | Name |
|----|--------------------------------------|
| 1 | Change menu |
| 2 | Display illumination / device on/off |
| 3 | For changing the calibration curve |

Additional function menu

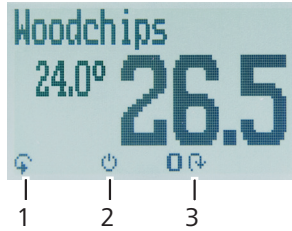

| No | Name |
|----|--------------------------------------|
| 1 | Change menu |
| 2 | Display illumination / device on/off |
| 3 | Mirror display |

Main menu

The main menu comprises the following menu items:

- **Edit Logs:**
Manual Logs, Clear Logs
- **Print Logs:**
Last Log, All Logs, Clear Logs
- **Send Logs:**
Manual Logs, Clear Logs
- **Options:**
Bluetooth, Date/Time, Log Time, Language, Unlock, °C/°F, BL On Time, Auto Off Time, Materialcalib., Password, Reset
- **Status**

Table of contents

| | |
|---|-----------|
| Your humimeter BLL at a glance | 2 |
| The whole unit | 2 |
| The main unit | 3 |
| Rear of the main unit | 3 |
| The display | 4 |
| The display symbols | 4 |
| The menus | 5 |
| 1. Introduction | 10 |
| 1.1 Information about this operating manual | 10 |
| 1.2 Limitation of liability | 10 |
| 1.3 Symbols used in this manual | 11 |
| 1.4 Customer service | 11 |
| 2. For your safety | 12 |
| 2.1 Proper use | 12 |
| 2.2 Improper use | 12 |
| 2.3 User qualifications | 12 |
| 2.4 General safety information | 13 |
| 2.5 Warranty | 13 |
| 3. On receipt of your device | 13 |
| 3.1 Taking the device out of its packaging | 13 |
| 3.2 Making sure that all of the components have been included | 14 |
| 3.3 Inserting batteries | 15 |
| 4. Using the device - Basics | 16 |
| 4.1 Switching the device on | 16 |
| 4.2 Selecting the calibration curve | 16 |
| 4.3 Taking a measurement | 16 |
| 4.4 Mirroring the display | 17 |
| 4.5 Switching the device off | 17 |
| 5. The measuring process | 17 |
| 5.1 Preparing a measurement | 17 |

| | | |
|-----------|---|-----------|
| 5.2 | Taking a measurement | 18 |
| 5.3 | Hold function - Freezing the displayed values | 19 |
| 5.3.1 | Activating the Hold function in the Options menu | 19 |
| 5.3.2 | Using the Hold function | 19 |
| 5.4 | Saving individual readings | 20 |
| 5.4.1 | Activating the manual save function in the options menu | 20 |
| 5.4.2 | Using the manual save option | 20 |
| 5.5 | Saving several readings (a measurement series) at the same time | 21 |
| 5.6 | Viewing individual readings | 23 |
| 5.7 | Viewing individual readings from a series of measurements | 23 |
| 5.8 | Deleting all measured values (data log) | 24 |
| 5.9 | Deleting individual measurement series | 24 |
| 5.10 | Deleting individual values from a single series of measurements | 25 |
| 6. | Calibration curves | 26 |
| 6.1 | How moisture content is defined | 26 |
| 6.2 | Definition wood chip types (in accordance with EN ISO 17225-1) | 26 |
| 6.3 | Selection of calibration curve for wood chips | 27 |
| 6.3.1 | Wood chips | 27 |
| 6.3.2 | Coarse wood chips | 27 |
| 6.3.3 | Industrial wood chips | 27 |
| 6.4 | Notes for comparative measurement with oven-drying method | 31 |
| 6.5 | Compression of wood chips | 31 |
| 7. | Using the LogMemorizer program | 32 |
| 7.1 | Installing / opening the program | 32 |
| 7.2 | Exporting measured values to a computer | 33 |
| 8. | Checking on the device's status | 35 |
| 9. | Configuring the device | 36 |
| 9.1 | Turning on Bluetooth | 36 |
| 9.2 | Adjust the date/time | 36 |
| 9.3 | Selecting a language | 37 |
| 9.4 | Activating options | 37 |
| 9.5 | Deactivating options | 38 |

| | | |
|------------|---|-----------|
| 9.6 | Selecting °C/°F | 38 |
| 9.7 | Reducing the device's power consumption | 38 |
| 9.7.1 | Configuring the display illumination time | 38 |
| 9.7.2 | Configuring automatic switch-off | 39 |
| 9.8 | Configuring the material calibration function | 40 |
| 9.9 | Changing the password | 40 |
| 9.10 | Resetting the device to its factory settings | 41 |
| 10. | Cleaning and maintenance | 41 |
| 10.1 | Changing batteries | 41 |
| 10.2 | Cleaning the device | 42 |
| 11. | Accessories | 43 |
| 11.1 | BLL tube extension | 43 |
| 11.1.1 | Overview tube extension and humimeter BLL | 43 |
| 11.1.2 | Demounting of the measuring tip | 44 |
| 11.1.3 | Installation of the extension | 44 |
| 11.1.4 | Tip assembly | 45 |
| 11.1.5 | Function test | 45 |
| 11.2 | Changing the measuring head (tip) | 45 |
| 12. | Faults | 46 |
| 13. | Storage and disposal | 47 |
| 13.1 | Storing the device | 47 |
| 13.2 | Disposing of the device | 47 |
| 14. | Device information | 48 |
| 14.1 | CE declaration of conformity | 48 |
| 14.2 | Technical data | 52 |
| 15. | Notes | 53 |

1. Introduction

1.1 Information about this operating manual

This operating manual is designed to enable you to use the humimeter BLL safely and effectively. It is part of the device, has to be stored nearby and must be easily accessible to users at all times.

All users are required to carefully read and make sure that they have understood this operating manual before using the humimeter BLL. All of the safety and operating instructions detailed in this manual have to be observed to ensure the safety of the device.

1.2 Limitation of liability

All of the information and instructions provided in this operating manual have been compiled on the basis of the current standards and regulations, the state of the art, and the extensive expertise and experience of Schaller Messtechnik GmbH.

Schaller Messtechnik GmbH does not accept any liability for damage associated with the following, which also voids the warranty:

- Non-observance of this operating manual
- Improper use
- Inadequately qualified users
- Unauthorised modifications
- Technical changes
- Use of unapproved spare parts

This fast measuring procedure can be affected by a range of different factors. For this reason, we recommend periodically checking the device's measurements with a standardised oven-drying method.

We, as the manufacturer, do not accept any liability for any incorrect measurements and associated consequential damage.

1.3 Symbols used in this manual

All of the safety information provided in this manual is shown with a corresponding symbol.



CAUTION

It is essential to observe this warning. Non-compliance can lead to injury.



ATTENTION

It is essential to observe this warning. Non-compliance can lead to damage to property or equipment.



Information

This symbol indicates important information that enables users to use the device more efficiently and cost-effectively.

1.4 Customer service

For technical advice, please contact our customer service department at:

Schaller Messtechnik GmbH
Max-Schaller-Straße 99
A - 8181 St.Ruprecht an der Raab

Telefon: +43 (0)3178 28899
Fax: +43 (0)3178 28899 - 901

E-Mail: info@humimeter.com
Internet: www.humimeter.com



© Schaller Messtechnik GmbH 2024

2. For your safety

The device complies with the following European directives:

- Restriction of Hazardous Substances in Electrical and Electronic Equipment (RoHS)
- Electromagnetic compatibility (EMC)

The device corresponds to state-of-the-art technology. However, it is still associated with a number of residual hazards.

These hazards can be avoided through strict observance of our safety information.

2.1 Proper use

- Easy to use device for quickly measuring the moisture content of wood chips
- The device must only be used for taking measurements on the products defined in the following sections of this manual (see "[6. Calibration curves](#)").

2.2 Improper use

- The device must not be used in ATEX.
- The device is not suitable for measuring frozen wood chips or wood chips with a temperature over +40 °C.
- The device is not waterproof and must be protected from water and fine dust (IP40).

2.3 User qualifications

The device must only be operated by people who can be expected to reliably take the measurements. The device must not be operated by people whose reaction times may be slowed due to, e.g. the use of drugs, alcohol or medication.

All persons using this device must have read, understood and follow the instructions provided in the operating manual.

2.4 General safety information

The following safety information has to be observed at all times to avoid damage to objects and injury to people:

- Remove the batteries if the device isn't used for a prolonged period of time.
- Keep the measuring head away from your body throughout all activities.
- Keep the measuring head away from other people throughout all activities.
- In case of damages or loose parts on the device, remove the batteries and contact Schaller Messtechnik GmbH or your dealer.

All of the device's technical features have been inspected and tested before delivery. Every device has a serial number. Do not remove the tag with the serial number.

2.5 Warranty

The warranty does not apply to:

- Damage resulting from non-observance of the operating manual
- Damage resulting from third-party interventions
- Products that have been used improperly or modified without authorisation
- Products with missing or damaged warranty seals
- Damage resulting from force majeure, natural disasters, etc.
- Damage from improper cleaning
- Batteries older than six months
- Damage resulting from improper strain (pressure, bending) of the insertion probe or the measuring head
- Damage by dropping the measuring head

3. On receipt of your device

3.1 Taking the device out of its packaging

- Take the device out of its packaging.
- Next, make sure that it is not damaged and that no parts are missing.

3.2 Making sure that all of the components have been included

Make sure that all of the components have been included by checking the package contents against the following list:

- humimeter BLL
- 4 pieces of AA Alkaline batteries
- Rubber protection cover
- Handle bar
- Operating manual

Optional accessories:

- humimeter USB data interface module - USB flash drive with software and USB-cable or download using humimeter.com/software
-
- Battery-powered portable thermo printer (can only be used in combination with humimeter USB data interface module) - described in a separate user manual.
- Bluetooth module (can only be used in combination with humimeter USB data interface module) - described in a separate user manual.
- Wooden case
- Replacement measuring head
- 1 meter tube extension
- Test block

3.3 Inserting batteries

1. Remove the rubber protection cover. To do so, hold the rubber protection cover at the upper side and pull it over. If your device is provided with an optional USB port, remove the protection cap of the USB socket before (figure 1 and 2).
2. Remove the handle bar by unscrewing it counterclockwise (figure 3).
3. Take hold of the device with one hand, press your thumb onto the engraved area of the battery compartment (1) and drag downwards (2) (figure 4).
4. Insert the batteries with negative and positive terminals matching those indicated on the battery compartment. Press down the batteries so that they lay flat on the bottom of the housing (figure 5).
 - » As soon as all batteries have been inserted, the device switches on automatically.
5. Push the battery cover onto the housing until it clicks into place. Then mount the rubber protection cover onto the housing, beginning at the end where the battery compartment is situated (figure 6).

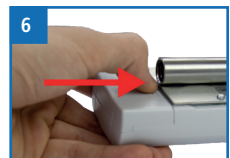
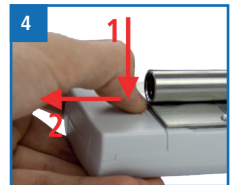

4. Using the device - Basics

4.1 Switching the device on



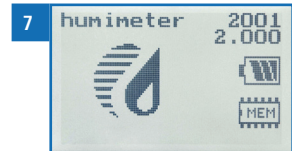

- Press the  button for 3 seconds.
- » The display will then show the status indicator (figure 7).
- » After inserting the batteries, the device switches on automatically.



4.2 Selecting the calibration curve

To do so: The device has to be in the product selection menu (figure 8).

For an overview of the different calibration curves and the criteria for selecting them, please refer to "6. Calibration curves"es".

1. Press the  or  button to move from one product to the next Or
2. Press the  or  button for 3 seconds to open the calibration curve overview (figure 9).
3. Use the arrow keys to move from one calibration curve to the next
4. and keep any of them pressed to scroll through the types.
5. Confirm your selection by pressing .

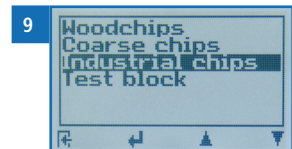



- » The calibration curve you selected will now be shown at the top of the display.

4.3 Taking a measurement

- For information on how to take a measurement, see section "5. The measuring process".

4.4 Mirroring the display

To do so: The device has to be in the additional function menu (figure 10).

- Press the  button to mirror the display.
- Press the  button again to cancel the mirroring of the display.



4.5 Switching the device off



To do so: The device has to be in the product selection, the Data Log or the additional function menu. It is not possible to switch off the device when it is in the main menu.

- Press the  button for 3 seconds.

5. The measuring process

5.1 Preparing a measurement

To do so: The device has to have nearly the same temperature than the product being measured. It is recommended to let your humimeter device adjust to the surrounding temperature of the wood chips before the measurement.

1. Switch on the device (see "4.1 Switching the device on").
2. Select the desired calibration curve (see "6. Calibration curves"es") by pressing the  or  button (see "4.2 Selecting the calibration curve"rve") (figure 12).

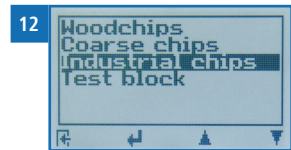

5.2 Taking a measurement

To do so: The device has to have nearly the same temperature than the product being measured.

- Insert the measuring head of the device straight into the wood chips (figure 13).
- » Do not bend or drop the measuring head!
- The device will now instantly display the moisture content on the display (figure 14).
- » The displayed value flashes when the moisture content exceeds 40 % (figure 15). A flashing value signals lowered accuracy of the measurement. The device has a measuring range of 10 % to 50 % water content.
- » Once the reading has been taken, it can be saved on the device (see "5.4 Saving individual readings" or "5.5 Saving several readings (a measurement series) at the same time").



CAUTION

Risk of injury

Risk of injury due to the measuring head

- ▶ Keep the measuring head away from your body throughout all activities.
- ▶ Keep the measuring head away from other people throughout all activities.



Information - Measuring accuracy

This rapid and non-destructive measuring procedure allows you to quickly take moisture readings at a number of different points. When saving the individual readings, the device will automatically calculate the readings' average (see "5.5 Saving several readings (a measurement series) at the same time").



Information - Incorrect readings













Always make sure to select the correct calibration curve for the material you are measuring. This prevents taking incorrect readings (see "11. Accessories").

5.3 Hold function - Freezing the displayed values

The device can be configured in such a way that the information being shown on the display will freeze at the touch of a button until a new button is pressed. This function can be very useful when e.g. taking readings in spaces where it is not possible to see the display (e.g. overhead).

5.3.1 Activating the Hold function in the Options menu

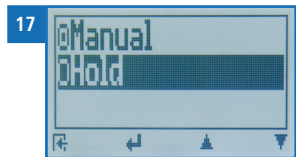
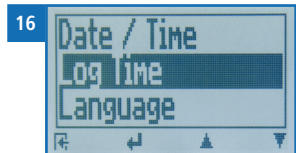

To do so: The device has to be switched on and be in the product selection menu.

1. Press  three times or hold for 2 seconds.
2. Select **Options**. To do so, press  or  and confirm by pressing .
3. Select **Log Time** (figure 16). To do so, press  or  and confirm by pressing .
4. Select **Hold** (figure 17). To do so, press  or  and confirm by pressing .
 - » The setting has been saved.
5. Press  to leave the **Options** menu.
6. Press  to leave the main menu.



5.3.2 Using the Hold function

To do so: The device has to be switched on and be in the Data Log menu (see "Data Log menu" page 5).

- Press .
- » The current reading will be frozen. All of the four symbols will now be displayed as  (figure 18).
- To reactivate the frozen display, simply press any button.















5.4 Saving individual readings

The device can be configured in such a way that the device will save a reading every time a button is pressed. This option (manual save function) is the device's default setting.

5.4.1 Activating the manual save function in the options menu

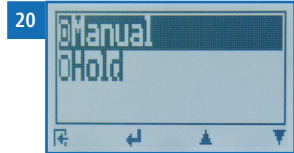
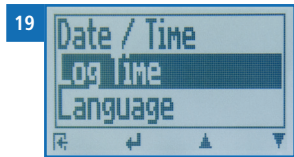

To do so: The device has to be switched on and be in the product selection menu.

1. Press  three times or hold for 2 seconds.
2. Select **Options**. To do so, press  or  and confirm by pressing .
3. Select **Log Time** (figure 19). To do so, press  or  and confirm by pressing .
4. Select **Manual** (figure 20). To do so, press  or  and confirm by pressing .
- » The setting has been saved.
5. Press  to leave the **Options** menu.
6. Press  to leave the main menu.



5.4.2 Using the manual save option

To do so: The device has to be in the Data Log menu (see "Data Log menu" page 5). The manual save option is set on the device.

1. Press .- » The display will now appear as shown in figure 22 and the disc symbol will be preceded by the digit one.
- 2. Press  to enter a name for the saved reading and to finish the measuring process.- » The display will now appear as shown in figure 23.

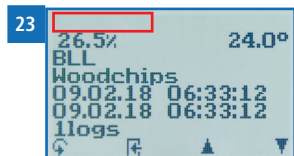

3. The data you have inputted can be overwritten at any time.

4. **Inputting letters:**

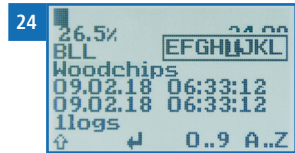

Press and hold **A..Z** to quickly scroll to the required letter and either press it for 3 seconds or press  to confirm the selected letter (figure 24).



5. **Inputting numbers:**

Press and hold **0..9** to quickly scroll to the required number and either press it for 3 seconds or press  to confirm the selected number.

6. **Moving forward/back:**

Press  to switch to another input level. Press  or  to move forward or back.

7. Confirm your entry by pressing .

» The data you entered has been saved.

5.5 Saving several readings (a measurement series) at the same time

To do so: The device has to be in the Data Log menu (see "Data Log menu" page 5).

1. Take several readings of the same wood chips (see "5. The measuring process").

2. To save a reading, press  as soon as the reading has been taken.



» The display will now appear as shown in figure 25. The marked number shows the number of readings that have already been saved.

3. Press  to enter a name for the saved series of measurements and to finish the measuring process.

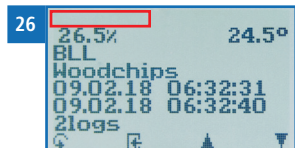

» The display will now appear as shown in figure 26.

4. The data you have inputted can be overwritten at any time.

5. **Inputting letters:**

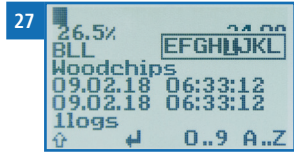

Press and hold **A..Z** to quickly scroll to the required letter and either press it for 3 seconds or press  to confirm the selected letter (figure 27).



6. **Inputting numbers:**

Press and hold **0..9** to quickly scroll to the required number and either press it for 3 seconds or press  to confirm the selected number.

7. **Moving forward/back:**

Press  to switch to another input level. Press  or  to move forward or back.

8. Confirm your entry by pressing .



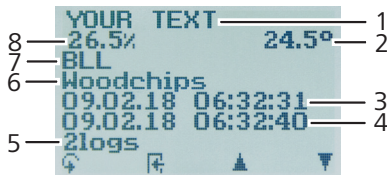

- » The data you entered has been saved.
- » The device automatically determines the average moisture content of the saved measuring values.
- » The display will show the following information:



| No | Name |
|----|---|
| 1 | Name of the measurement series (editable) |
| 2 | Temperature (average) |
| 3 | Date & start time of the measurement series |
| 4 | Date & end time of the measurement series |
| 5 | Number of saved readings |
| 6 | Calibration curve |
| 7 | Device name |
| 8 | Moisture content (average) |

5.6 Viewing individual readings





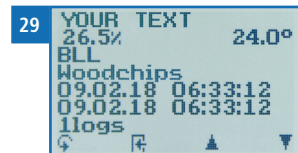



To do so: You must have saved a reading (e.g. **1 log**)
The display will now appear as shown in figure 28.

1. Press .
2. Select the required reading. To do so, press  or .
 - » The display will now appear as shown in figure 29.
 - » Press  to leave this screen.



5.7 Viewing individual readings from a series of measurements





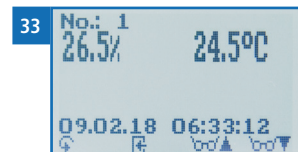
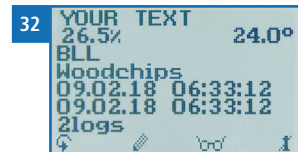
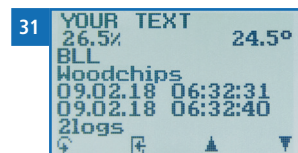





To do so: You must have saved a series of measurements (e.g. **2 logs**)
The display will now appear as shown in figure 30.

1. Press .
2. Navigate to the required measurement series. To do so, press  or .
 - » The display will now appear as shown in figure 31.
3. Press  to switch to another input level.
 - » The display will now appear as shown in figure 32.
4. Press  again.
 - » The display will now appear as shown in figure 33.
5. Navigate to the required reading (**No.: 1, No.: 2, No.: 3**). To do so, press  or .
6. Press  to leave this screen.



5.8 Deleting all measured values (data log)



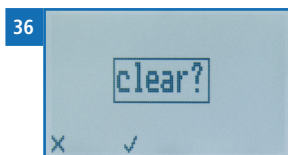
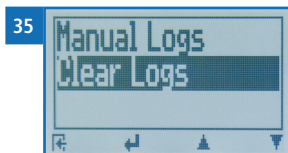
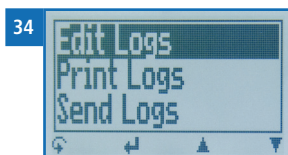

To do so: You must have taken and saved one or several readings.

1. Press  three times or hold for 2 seconds.
2. Select **Edit Logs** (figure 34). To do so, press  or  and confirm by pressing .
3. Select **Clear Logs** (figure 35). To do so, press  or  and confirm by pressing .
 - » The display will show the message **clear?** (figure 36).
4. Confirm by pressing .
 - » The data log has been deleted.
5. Press  to leave the **Edit Logs** menu.
6. Press  to leave the main menu.



5.9 Deleting individual measurement series

To do so: You must have saved a measured value (e.g. **1 log**) or a series of measurements (e.g. **3 logs**). The display will now appear as shown in figure 37.

1. Press .
 - » The display will now appear as shown in figure 38.
2. Select the required reading. To do so, press  or .
3. Press  to switch to another input level.
 - » The display will now appear as shown in figure 39.
4. Press .

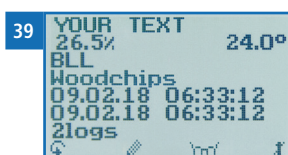
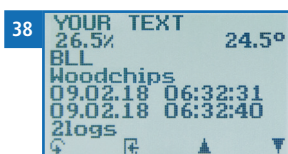

- » The display will then show the message **clear?** (figure 40).

5. Confirm by pressing .

- » The value has been deleted.

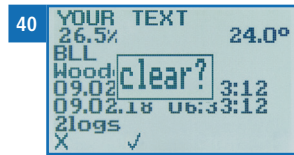



5.10 Deleting individual values from a single series of measurements

To do so: You must have saved a series of measurements comprising at least 2 logs. The display will now appear as shown in figure 41.

1. Press .

- » The display will now appear as shown in figure 42.



2. Select the required reading. To do so, press  or .

3. Press  to switch to another input level.

- » The display will now appear as shown in figure 43.

4. Press .

- » The display will now appear as shown in figure 44.

5. Select the required measured value. To do so, press  or .

6. Press  to switch to another input level.

- » The display will now appear as shown in figure 45.

7. Press  to delete the value shown.

- » The display will then show the message **clear?** (figure 46).

8. Confirm by pressing .

- » The value has been deleted.

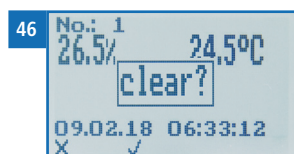
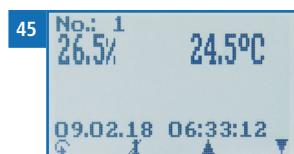
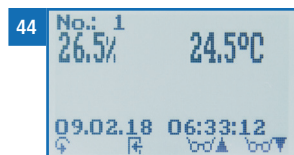
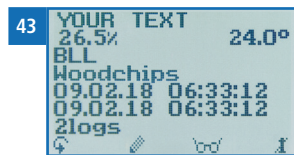
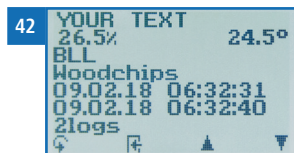
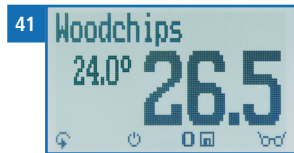

6. Calibration curves

| Calibration curve | Wood chip type | Measuring range |
|-----------------------|---|-----------------|
| Wood chips | See " 6.3.1 Wood chips " | 10 % - 50 % |
| Coarse wood chips | See " 6.3.2 Coarse wood chips " | 10 % - 50 % |
| Industrial wood chips | See " 6.3.3 Industrial wood chips " | 10 % - 50 % |
| Test block | ! Only for testing the moisture meter ! | |

6.1 How moisture content is defined

The device measures and shows a material's moisture content. The moisture content readings it displays are calculated in relation to the material's overall mass:

$$\%WG = \frac{M_n - M_t}{M_n} \times 100$$

M_n : Mass of the sample with average moisture content

M_t : Mass of the sample with zero moisture content

%WG: Moisture content (in accordance with EN ISO 18134-2)

6.2 Definition wood chip types (in accordance with EN ISO 17225-1)

The given numbers refer to the particle sizes that fit through the round screen openings.

- P16 at least 75 % of the mass between 3.15 and 16 mm
- P31 at least 75 % of the mass between 8 and 31.5 mm
- P45 at least 75 % of the mass between 8 and 45 mm
- P63 at least 75 % of the mass between 8 and 63 mm

6.3 Selection of calibration curve for wood chips

The calibration curves for wood chips depend on the wood type (hardwood, softwood), the size of the chips (size classes according to norm EN ISO 17225-1) as well as on the content of fine fraction.

If you are not sure which calibration curve is the best suited for your material, it is recommended to carry out a reference measurement by kiln-drying (according to EN ISO 18134-2).

Schaller Messtechnik GmbH will be happy to advise you on the selection of the right calibration curve. Please send a picture of your wood chips, placing a measuring tape to the material, to support@schaller-gmbh.at. You will receive a recommendation from us immediately.

6.3.1 Wood chips

For wood chips with fine fraction, mainly consisting of hardwood (maximum proportion of softwood of 30 %). For wood chips sizes from P31 to P45. The fine fraction mainly derives from barks, small branches and bushes. See example pictures [47](#) and [48](#).

If your wood chips don't contain small parts (few fine fraction or no fine fraction) or if the wood chips contain a higher proportion of softwood, use one of the following calibration curves.

6.3.2 Coarse wood chips

For coarse wood chips without fine fraction, mainly consisting of hardwood (maximum proportion of softwood of 30 %). This curve also has to be used for wood chips with fine fraction, mainly consisting of softwood, with a proportion of softwood (spruce, fir, pine, larch) of 70 % and more. For wood chips sizes from P31 to P63. See example pictures [49](#) and [50](#).

If your wood chips mainly consist of softwood and don't contain small parts (few fine fraction or no fine fraction), use the following calibration curve.

6.3.3 Industrial wood chips

For coarse wood chips without fine fraction, mainly consisting of softwood, with a proportion of softwood (spruce, fir, pine, larch) of 70 % and more. For wood chips sizes from P45 to P63. This curve is predominantly suited for measuring wood chips deriving from logs and full trees as well as sawmill residues without fine fraction. See example pictures [51](#) and [52](#).

Example pictures wood chips



Example pictures coarse wood chips



Example pictures industrial wood chips



6.4 Notes for comparative measurement with oven-drying method

The device uses a much higher sample quantity than the drying oven (12-fold to 20-fold quantity of kiln-drying method). Furthermore, to determine a more accurate average moisture value in case of inhomogeneous material, there can be effected several measurements within a short time.

Considering a sampling error due to the considerably smaller sample quantity as well as the content of volatile matters (resin etc.) that are not water, the kiln-drying method will practically reach an accuracy of approx. $\pm 3\%$. Therefore, if the measuring values of these two very different methods of determining the water content are compared, differences of $\pm 3\%$ can be considered to be normal.

In the standard EN ISO 18134-2 is declared that the drying oven method provides no absolute values, but only comparable values.

6.5 Compression of wood chips

The humimeter BLL is calibrated for normally compressed wood chips. If the wood chips being measured are much less or much more compressed, the accuracy of the measurement will decrease. Normally compressed wood chips are defined in norm EN 15103 (determination of the bulk density).

7. Using the LogMemorizer program

To do so: The device is provided with USB interface, and the USB stick with LogMemorizer software and USB cable are available. Otherwise, you can also install the software at humimeter.com/software or by scanning the QR code.



7.1 Installing / opening the program

1. Insert the USB stick with the LogMemorizer program into the USB port on your computer or
 - » download the LogMemorizer software at humimeter.com/software or use the QR code.
2. Open the **setup** application.
3. Follow the installation instructions.
4. Open LogMemorizer.
 - » The screen will now display the LogMemorizer's interface (figure 53).

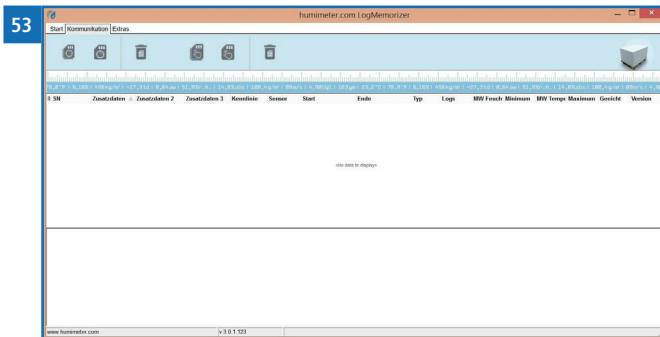

- » Before using LogMemorizer, please refer to the the separate LogMemorizer operating manual for the correct configuration of the USB COM Port.

For more information on LogMemorizer, please refer to the separate LogMemorizer operating manual supplied with the device.







7.2 Exporting measured values to a computer

To do so: LogMemorizer must be installed. And you must have taken and saved one or several moisture readings.

Options: You can export moisture readings from the humimeter BLL or initiate the export at your computer.

Exporting moisture readings from the humimeter BLL

Connect the humimeter BLL to your computer using the supplied USB cable:

1. Insert the USB Mini B connector into the humimeter BLL (figure 54).
2. Insert the USB connector into the computer.
3. Open LogMemorizer on your computer.
4. Switch on the humimeter BLL.
5. Press  three times or hold for 2 seconds.
6. Select **Send Logs** (figure 55). To do so, press  or  and confirm by pressing .
7. Select **Manual Logs** (figure 56). To do so, press  or  and confirm by pressing .
 - » The display will then show the message **Send** (figure 57).
 - » All of the measuring values saved on the humimeter BLL will now be sent to your computer.

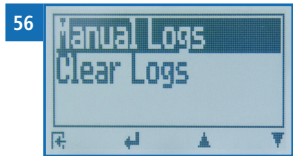
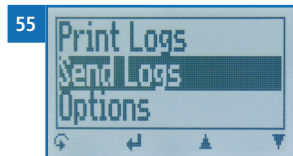

Initiating the data export at your computer

Connect the humimeter BLL to your computer using the supplied USB cable:

1. Insert the USB Mini B connector into the humimeter BLL (figure 58).
2. Insert the USB connector into the computer.
3. Open LogMemorizer on your computer.



4. Switch on the humimeter BLL.
5. Open the **Communication** tab in LogMemorizer (figure 59).

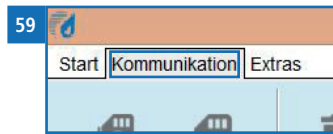





6. Select and click on one of the two buttons shown in figure 60.
 - » **Import all manual logs** (for importing all manually saved readings) **or**
 - » **Import most recent manual log** (for importing the most recent manually saved logs).



| No | Name |
|----|-------------------------------|
| 1 | Import all manual logs |
| 2 | Import most recent manual log |



- » The measuring values saved on the humimeter BLL will now be sent to your computer.

8. Checking on the device's status

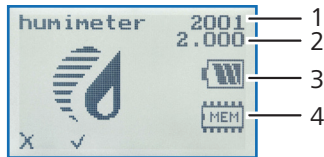
1. Press  three times or hold for 2 seconds.
2. Select **Status**. To do so, press  or  and confirm by pressing .
 - » The display will then show the status indicator **humimeter**.
 - » The display will show the following information:



| No | Name |
|----|------------------|
| 1 | Serial number |
| 2 | Software version |
| 3 | Battery status |
| 4 | Memory status |















3. Confirm by pressing .
4. Press  to leave the main menu.

9. Configuring the device

9.1 Turning on Bluetooth







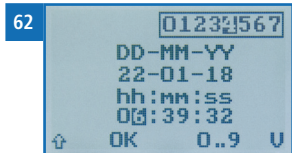
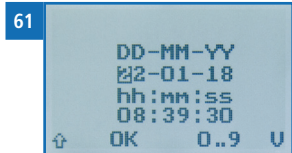





The information on Bluetooth is provided in a separate operating manual.

9.2 Adjust the date/time

1. Press  three times or hold for 2 seconds.
2. Select **Options**. To do so, press  or  and confirm by pressing .
3. Select **Date/Time**. To do so, press  or  and confirm by pressing .
 - » The display will now appear as shown in figure 61.
 - » The format for the date is **DD-MM-YY** (Day-Month-Year).
 - » The format for the time is **hh:mm:ss** (Hour:Minutes:Seconds).
4. **Inputting numbers:**
Press and hold  to quickly scroll to the required number and either press it for 3 seconds or press  to confirm the selected number (figure 62).
5. **Moving forward:**
To move forward between **DD-MM-YY** and **hh:mm:ss**, press .
6. **Moving back:**
Press  to switch to another input level. To move backward between **DD-MM-YY** and **hh:mm:ss**, press .
7. Confirm the date/time by pressing .
 - » The settings have been saved.
8. Press  to leave the **Options** menu.
9. Press  to leave the main menu.









9.3 Selecting a language

1. Press  three times or hold for 2 seconds.
2. Select **Options**. To do so, press  or  and confirm by pressing .
3. Select **Language**. To do so, press  or  and confirm by pressing .
4. Navigate to the required language. To do so, press  or  and confirm by pressing .
 - » The settings have been saved.
5. Press  to leave the **Options** menu.
6. Press  to leave the main menu.

9.4 Activating options

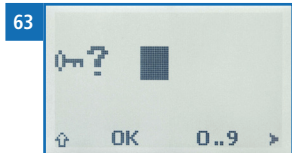

To do so: Some of the options must be deactivated.

1. Press  three times or hold for 2 seconds.
2. Select **Options**. To do so, press  or  and confirm by pressing .
3. Select **Unlock**. To do so, press  or  and confirm by pressing .
 - » The display will now appear as shown in figure 63.
 - » On delivery, the four-digit password is the device's serial number.

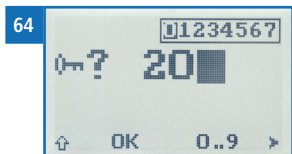

4. **Inputting numbers:**
 Press and hold **0..9** to quickly scroll to the required number and either press it for 3 seconds or press  to confirm the selected number (figure 64).



5. **Moving back:**
 Press  to switch to another input level.
 To move back, press .
6. Confirm the four-digit password by pressing **OK**.
 - » The settings have been saved.

- » The °C/°F, **BL On Time**, **Auto Off Time**, **Materialcalib.**, **Password**, **Reset** options are now activated.

7. Press  to leave the **Options** menu.

8. Press  to leave the main menu.

9.5 Deactivating options

Once the device has been switched restarted, the °C/°F, **BL On Time**, **Auto Off Time**, **Materialcalib.**, **Password**, **Reset** options will be deactivated again.



9.6 Selecting °C/°F

To do so: All of the options must be activated (see "9.4 Activating options").

1. Press  three times or hold for 2 seconds.

2. Select **Options**. To do so, press  or  and confirm by pressing .

3. Select °C/°F. To do so, press  or  and confirm by pressing .

4. Navigate to the required temperature scale, i.e. Celsius (°C) or Fahrenheit (°F). To do so, press  or  and confirm by pressing .

- » The settings have been saved.

5. Press  to leave the **Options** menu.

6. Press  to leave the main menu.

9.7 Reducing the device's power consumption





9.7.1 Configuring the display illumination time

To do so: All of the options must be activated (see "9.4 Activating options").

1. Press  three times or hold for 2 seconds.













2. Select **Options**. To do so, press  or  and confirm by pressing .

3. Select **BL On Time**. To do so, press  or  and confirm by pressing .

4. Select the required display illumination period (30 seconds, 2 minutes, 5 minutes, 10 minutes). To do so, press  or  and confirm by pressing .
- » The settings have been saved.
5. Press  to leave the **Options** menu.
6. Press  to leave the main menu.

9.7.2 Configuring automatic switch-off

To do so: All of the options must be activated (see "9.4 Activating options").









1. Press  three times or hold for 2 seconds.
2. Select **Options**. To do so, press  or  and confirm by pressing .
3. Select **Auto Off Time**. To do so, press  or  and confirm by pressing .
4. Select the period of time you want the device to stay switched on (3 minutes, 5 minutes, 10 minutes). To do so, press  or  and confirm by pressing .
- » The settings have been saved.
5. Press  to leave the **Options** menu.
6. Press  to leave the main menu.

9.8 Configuring the material calibration function

The type calibration function is described in a separate operating manual.

9.9 Changing the password



To do so: All of the options must be activated (see "9.4 Activating options").

1. Press  three times or hold for 2 seconds.
2. Select **Options**. To do so, press  or  and confirm by pressing .
3. Select **Password**. To do so, press  or  and confirm by pressing 
 - » The display will show the current password.
4. Overwrite the current password. To do so, press and hold **0..9** to quickly scroll to the required number and either press it for 3 seconds or press  to confirm the selected number.

Moving back:









Press  to switch to another input level.

To move back, press .

5. Confirm the new four-digit password by pressing **OK**.
 - » The setting has been saved.
6. Press  to leave the **Options** menu.
7. Press  to leave the main menu.

9.10 Resetting the device to its factory settings

To do so: All of the options must be activated (see "9.4 Activating options").

1. Press  three times or hold for 2 seconds.
2. Select **Options**. To do so, press  or  and confirm by pressing .
3. Select **Reset**. To do so, press  or  and confirm by pressing .
 - » The display will then show the message **Reset?** (figure 65).
4. Confirm by pressing .
 - » The device will now be reset to its factory settings. All of your personal settings will be lost.
 - » The display will show the status indicator **humi meter** (figure 66).
 - » Resetting the device will not affect the saved measuring values.

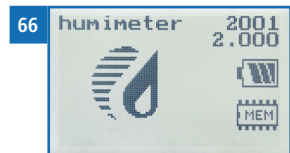
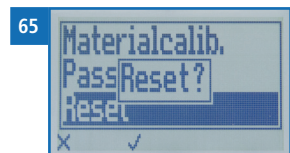

10. Cleaning and maintenance

Regularly cleaning and maintaining the device will ensure that it will have a long service life and stay in good condition.

10.1 Changing batteries

The device constantly monitors the charge level of the batteries. The current battery status is shown on the status screen.

If the battery's charge is very low, the battery symbol will be shown with an exclamation mark. In that case, the batteries must be changed immediately (figure 68).

For changing the batteries, see section "3.3 Inserting batteries".

As the device's user, you are responsible by law for properly disposing of all used batteries, which must not be disposed of as domestic waste (Battery Directive).

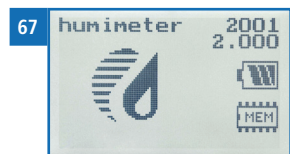

5. Care instructions

- Do not leave the device out in the rain. The device is not waterproof.
- Do not expose the device to extreme temperatures.
- Protect the device from strong mechanical shocks and loads.

10.2 Cleaning the device

Plastic housing

- Clean the plastic housing with a dry cloth.

Measuring head

- The measuring head can be cleaned with a cloth and cleaning alcohol.



ATTENTION

Do not clean with fluids

Water or cleaning fluid getting inside the device can destroy the device.

- ▶ Only clean the plastic housing with dry materials.

11. Accessories

11.1 BLL tube extension

Optional accessory for extending the measuring tube one meter. Art.No. 12467

11.1.1 Overview tube extension and humimeter BLL

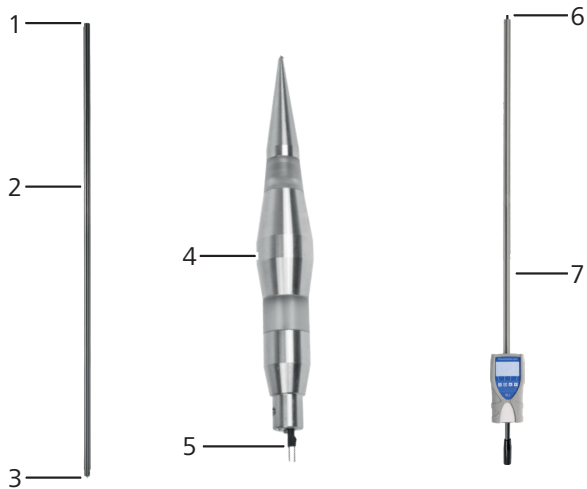

| No | Name |
|----|-----------------------|
| 1 | Socket extension |
| 2 | Extension (tube) |
| 3 | Connenction extension |
| 4 | Measuring tip |
| 5 | Connection tip |
| 6 | Socket basic unit BLL |
| 7 | Basic unit BLL |

11.1.2 Demounting of the measuring tip



CAUTION

Risk of injury

Risk of injury through the measuring tip.

- ▶ Keep the measuring tip away from your body during all activities.
- ▶ Keep the measuring tip away from other peoples' bodies during all activities.

Remove the batteries from the humimeter BLL.

Loosen the two screws which fix the measuring tip in the tube with a PH1 cross-head screwdriver.

Now carefully pull the tip out of the tube and release the connector between the tip and the tube.

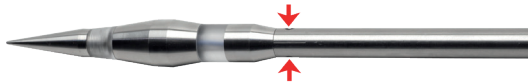

11.1.3 Installation of the extension

Place the tube on the basic humimeter BLL unit together with the extension tube on a table.

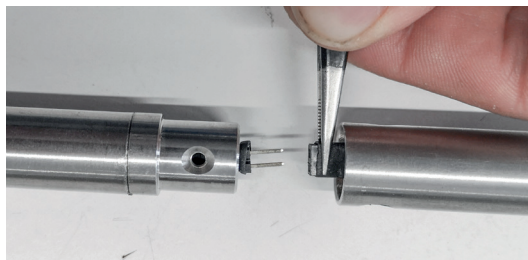

Now insert the connector of the extension into the socket of the basic unit. (The socket can be held with tweezers, for example.) Make sure that the connector is pushed all the way into the socket.

Now carefully insert the extension tube into its basic unit tube.

Align the tube by twisting it, so the holes match up in order to apply the screws.

Now tighten the two M3x5 countersunk screws again.

11.1.4 Tip assembly

Carefully insert the plug of the measuring tip into the socket of the tube. (The socket can be held in place with tweezers, for example).



Now carefully insert the measuring tip into the tube. Now align the measuring tip by twisting it so that the holes match in order to attach the screws.

Now tighten the two M3x5 countersunk screws again.

11.1.5 Function test

Reinsert the batteries into the humimeter BLL.

Hold the measuring tip in the air: The measuring device must display a moisture value of 0.0.

Now grab the measuring tip with your hand: The measuring instrument must display a moisture value between 5 % and 50 %.

11.2 Changing the measuring head (tip)

If the measuring head is defective (e.g. the tip is broken), you can exchange it. For this purpose, the item: "Measuring head humimeter BLL (spare part)" Art.No. 12472 is required.

Please perform the steps described in item ["11.1.2 Demounting of the measuring tip" page 44](#) and ["11.1.4 Tip assembly" page 45](#). Then perform a functional test. See ["11.1.5 Function test" page 45](#)

12. Faults

If the measures listed below fail to remedy any faults or if the device has faults not listed here, please contact Schaller Messtechnik GmbH.

| Fault | Cause | Remedy |
|---------------------------------------|---|--|
| Measuring error | The temperature of the material being measured is too low or high. I.e. the material's temperature is lower than 0 °C or higher than +40 °C | The temperature of the material being measured has to be between 0 °C and +40 °C. |
| | Temperature discrepancy between device and material being measured | Let the temperature adjust to the material being measured (permitted difference of max. 3 °C). |
| | Wrong calibration curve | Check whether you have selected the right calibration curve (product) before taking a reading (see " 6.3 Selection of calibration curve for wood chips "). |
| | Moldy or rain wet wood chips | The accuracy of the measurement decreases significantly. |
| | Frozen wood chips or wood chips mixed with snow | The accuracy of the measurement decreases significantly. |
| | Water film on the measuring head | After measuring wet wood chips, on the measuring head may arise a water film. Clean the measuring head (see " 10.2 Cleaning the device "). |
| Data transfer to Log-Memorizer failed | Interface has not been configured | The interface only has to be configured once. To do so, press the F1 key on your computer and read the Help file for your Log-Memorizer program. |

13. Storage and disposal

13.1 Storing the device

The device must be stored as follows:

- Do not store outdoors
- Store in a dry and dust-free place
- Protect the device from sunlight
- Avoid mechanical shocks/loads
- Remove the batteries if the device isn't used for a period of 2 months or longer.
- Storage temperature: -20 °C to +60 °C

13.2 Disposing of the device



Devices marked with this symbol are subject to Directive 2012/19/ EU of the European Parliament and of the Council of 4 July 2012 on waste electrical and electronic equipment (WEEE).

If the device is being operated outside the European Union, the national regulations on the disposal of such devices that apply in the country of use must be observed.

Electronic devices must not be disposed of as domestic waste.

The device must be disposed of appropriately using appropriate collection systems.

14. Device information

14.1 CE declaration of conformity

CE KONFORMITÄTSERKLÄRUNG DECLARATION OF CONFORMITY

Name/ Adresse des Herstellers: **Schaller Messtechnik GmbH**
Name/ address of manufacturer: **Max-Schaller-Straße 99**
A – 8181 St. Ruprecht

Produktbezeichnung: **humimeter**
Product designation:

Typenbezeichnung: **BL2 ; BLL ; BLH ; BLW ; FL1 ; FL2 ; FLH ; FLM ; FLS ; RM1 ;
SLW ; WLW**
Type designation:

Produktbeschreibung: **Messgerät zur Bestimmung des Wassergehalts in
Biomasse und diversen Schüttgütern**
Product description **Measuring device for determining the water content in bio-
mass and various bulk materials**

Das bezeichnete Produkt erfüllt die Bestimmungen der Richtlinien:
The designated product is in conformity with the European directives:

EMV - Richtlinie 2014/30/EC

EMC Directive 2014/30/EU

RoHS - Richtlinie 2011/65/EG

RoHS-Directive 2011/65/EU

Die Übereinstimmung des bezeichneten Produktes mit den Bestimmungen der Richtlinien wird durch die vollständige Einhaltung folgender Normen nachgewiesen:

Full compliance with the standards listed below proves the conformity of the designated product with the provisions of the above-mentioned EC Directives:

EN 61326-1:2013

Elektrische Mess-, Steuer-, Regel- und Laborgeräte - EMV-Anforderungen
Electrical equipment for measurement, control, and laboratory use – EMC requirements

EN IEC 63000:2019-05
ersetzt / replaced
EN 50581:2012

Technische Dokumentation zur Beurteilung von Elektro- und Elektronikgeräten hinsichtlich der Beschränkung gefährlicher Stoffe.
Technical documentation for the assessment of electrical and electronic products with respect to the restriction of hazardous substances.

Für das angeführte Produkt ist eine vollständige Dokumentation mit Betriebsanleitung in Originalfassung vorhanden.

For the mentioned product a complete documentation with manual of instruction in original version is available.

Bei Änderungen, die nicht vom Hersteller spezifiziert sind, verliert diese Konformitätserklärung die Gültigkeit.

In case of any changes not agreed upon with the manufacturer, this declaration of conformity loses its validity.

St. Ruprecht a.d. Raab, 31.07.2022

 **Schaller**
Messtechnik / humimeter.com
Schaller Messtechnik GmbH
Ma - Schaller Straße 99
AT-8180 St. Ruprecht a.d. Raab
www.humimeter.com | info@humimeter.com
.....
Bernhard Maunz
Rechtsverbindliche Unterschrift des Ausstellers
Legal binding signature of the issuer



DECLARATION OF CONFORMITY

Name/ address of manufacturer: **Schaller Messtechnik GmbH
Max-Schaller-Straße 99
A – 8181 St. Ruprecht**

Product designation: **humimeter**

Type designation: **BL2 ; BLL ; BLH ; BLW ; FL1 ; FL2 ; FLH ; FLM ; FLS ; RM1 ;
SLW ; WLW**

Product description: **Measuring device for determining the water content in bio
mass and various bulk materials**

The designated product is in conformity with the following directives:

- **Electromagnetic Compatibility Regulations 2016 Great Britain**
- **RoHS-Directive 2011/65/EU Directive on the restriction of the use of certain hazardous substances in electrical and electronic equipment**



Full compliance with the standards listed below proves the conformity of the designated product with the provisions of the above-mentioned Directives:

| | |
|---|---|
| EN 61326–1:2013 | Electrical equipment for measurement, control, and laboratory use – EMC requirements |
| EN IEC 63000:2019-05 replaced EN 50581:2012 | Technical documentation for the assessment of electrical and electronic products with respect to the restriction of hazardous substances. |

For the mentioned product, a complete documentation with manual of instruction in original version is available.

In case of any changes not agreed upon with the manufacturer, this declaration of conformity loses its validity.

St. Ruprecht a.d. Raab, 31.07.2022



 **Schaller**
Messtechnik / humimeter.com
Schaller Messtechnik GmbH
100 - Schallerstraße 99
AT-8180 St. Ruprecht a.d. Raab
www.humimeter.com | info@humimeter.com
.....
Bernhard Maunz
Legal binding signature of the issuer

14.2 Technical data

| | |
|-----------------------------|--|
| Display resolution | 0.5 % moisture content, 0.5 °C/°F temperature |
| Measuring range | 10 % to 50 % moisture content |
| Operating temperature | 0 °C to +40 °C |
| Temperature measuring range | -10 °C to +80 °C |
| Storage temperature | -20 °C to +60 °C |
| Temperature compensation | Automatic |
| Data memory | Up to 10,000 measuring values |
| Power supply | 4 x 1.5 Volt AA Alkaline batteries |
| Current consumption | 60 mA (incl. display illumination) |
| Menu languages | German, English, French, Italian, Spanish, Portuguese, Czech, Polish, Russian, International |
| Display | 128 x 64 illuminated matrix display |
| Device dimensions | 1155 x 75 x 45 mm (without handle bar) |
| Device weight | 830 g |
| Device IP rating | IP 40 |

15. Notes

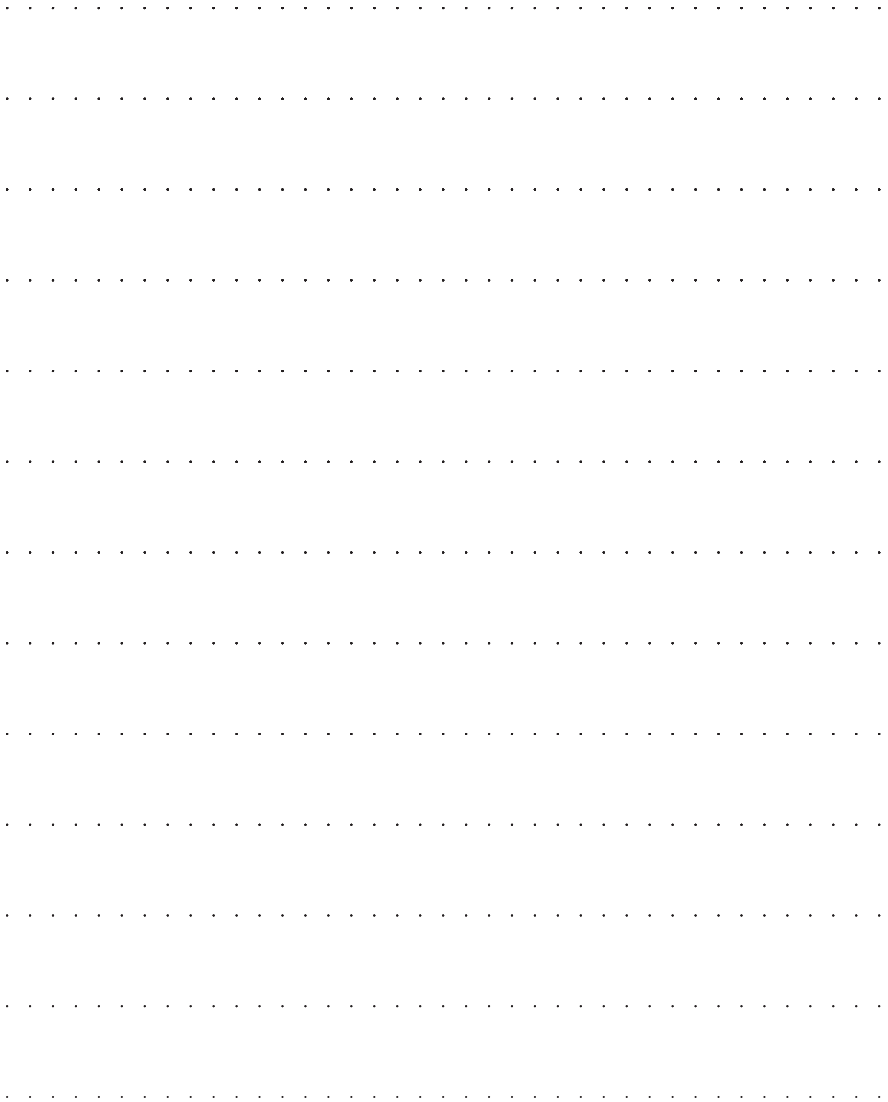
A series of horizontal dotted lines for taking notes.



.....

.....

.....

.....

.....

.....

.....

.....

.....

.....

.....

.....

.....

.....

.....

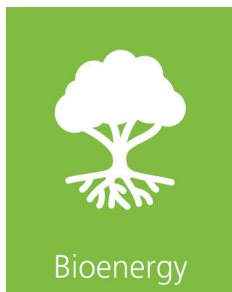
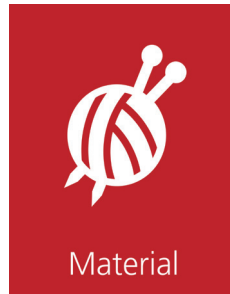

Schaller Messtechnik develops, produces and sells professional moisture meters and turnkey solutions.

Schaller Messtechnik GmbH

Max-Schaller-Straße 99, A - 8181 St. Ruprecht an der Raab

Tel +43 (0)3178 - 28899 , Fax +43 (0)3178 - 28899 - 901

info@humimeter.com, www.humimeter.com