

# FLIR A68/A38 Series

## IR Camera User's Manual



May 18, 2022  
[www.teledyneflir.com](http://www.teledyneflir.com)

 **TELEDYNE** | Teledyne FLIR  
Teledyne FLIR, a business unit of Teledyne Digital Imaging Inc.

**Important note**

Before operating the device, you must read, understand, and follow all instructions, warnings, cautions, and legal disclaimers.

**Důležitá poznámka**

Před použitím zařízení si přečtěte veškeré pokyny, upozornění, varování a vyvázání se ze záruky, ujistěte se, že jim rozumíte, a řiďte se jimi.

**Viktig meddelelse**

Før du betjener enheden, skal du læse, forstå og følge alle anvisninger, advarsler, sikkerhedsforanstaltninger og ansvarsfraskrivelser.

**Wichtiger Hinweis**

Bevor Sie das Gerät in Betrieb nehmen, lesen, verstehen und befolgen Sie unbedingt alle Anweisungen, Warnungen, Vorsichtshinweise und Haftungsausschlüsse

**Σημαντική σημείωση**

Πριν από τη λειτουργία της συσκευής, πρέπει να διαβάσετε, να κατανοήσετε και να ακολουθήσετε όλες τις οδηγίες, προειδοποιήσεις, προφυλάξεις και νομικές αποποιήσεις.

**Nota importante**

Antes de usar el dispositivo, debe leer, comprender y seguir toda la información sobre instrucciones, advertencias, precauciones y renuncias de responsabilidad.

**Tärkeä huomautus**

Ennen laitteen käyttämistä on luettava ja ymmärrettävä kaikki ohjeet, vakavat varoitukset, varoitukset ja lakitiedotteet sekä noudatettava niitä.

**Remarque importante**

Avant d'utiliser l'appareil, vous devez lire, comprendre et suivre l'ensemble des instructions, avertissements, mises en garde et clauses légales de non-responsabilité.

**Fontos megjegyzés**

Az eszköz használatá előtt figyelmesen olvassa el és tartsa be az összes utasítást, figyelmeztetést, óvintézkedést és jogi nyilatkozatot.

**Nota importante**

Prima di utilizzare il dispositivo, è importante leggere, capire e seguire tutte le istruzioni, avvertenze, precauzioni ed esclusioni di responsabilità legali.

重要な注意 デバイスをご使用になる前に、あらゆる指示、警告、注意事項、および免責条項をお読み頂き、その内容を理解して従ってください。

중요한 참고 사항

장치를 작동하기 전에 반드시 다음의 사용 설명서와 경고, 주의사항, 법적 책임제한을 읽고 이해하며 따라야 합니다.

**Viktig**

Før du bruker enheten, må du lese, forstå og følge instruksjoner, advarsler og informasjon om ansvarsfraskrivelse.

**Belangrijke opmerking**

Zorg ervoor dat u, voordat u het apparaat gaat gebruiken, alle instructies, waarschuwingen en juridische informatie hebt doorgelezen en begrepen, en dat u deze opvolgt en in acht neemt.

**Ważna uwaga**

Przed rozpoczęciem korzystania z urządzenia należy koniecznie zapoznać się z wszystkimi instrukcjami, ostrzeżeniami, przestrogam i uwagami prawnymi. Należy zawsze postępować zgodnie z zaleceniami tam zawartymi.

**Nota importante**

Antes de utilizar o dispositivo, deverá proceder à leitura e compreensão de todos os avisos, precauções, instruções e isenções de responsabilidade legal e assegurar-se do seu cumprimento.

**Важное примечание**

До того, как пользоваться устройством, вам необходимо прочитать и понять все предупреждения, предостережения и юридические ограничения ответственности и следовать им.

**Viktig information**

Innan du använder enheten måste du läsa, förstå och följa alla anvisningar, varningar, försiktighetsåtgärder och ansvarsfriskrivningar.

**Önemli not**

Cihazı çalıştırmadan önce tüm talimatları, uyarıları, ikazları ve yasal açıklamaları okumalı, anlamalı ve bunlara uymalısınız.

重要注意事項

在操作设备之前，您必须阅读、理解并遵循所有说明、警告、注意事项和法律免责声明。

重要注意事項

操作裝置之前，您務必閱讀、了解並遵循所有說明、警告、注意事項與法律免責聲明

## **Copyright**

© 2022 FLIR Systems, Inc. All rights reserved worldwide. No parts of the software including source code may be reproduced, transmitted, transcribed or translated into any language or computer language in any form or by any means, electronic, magnetic, optical, manual or otherwise, without the prior written permission of FLIR Systems.

The documentation must not, in whole or part, be copied, photocopied, reproduced, translated or transmitted to any electronic medium or machine readable form without prior consent, in writing, from FLIR Systems.

Names and marks appearing on the products herein are either registered trademarks or trademarks of FLIR Systems and/or its subsidiaries. All other trademarks, trade names or company names referenced herein are used for identification only and are the property of their respective owners.

## **Legal disclaimer**

For warranty terms, refer to <https://www.flir.com/warranty>.

## **Quality assurance**

The Quality Management System under which these products are developed and manufactured has been certified in accordance with the ISO 9001 standard.

FLIR Systems is committed to a policy of continuous development; therefore we reserve the right to make changes and improvements on any of the products without prior notice.

# Contents

<b>FIGURES.....</b>	<b>8</b>
<b>TABLES.....</b>	<b>10</b>
<b>NOTICE TO USER.....</b>	<b>11</b>
<i>Disposal of electronic waste.....</i>	<i>11</i>
<i>Training.....</i>	<i>11</i>
<i>Documentation updates.....</i>	<i>11</i>
<i>Note about authoritative versions.....</i>	<i>11</i>
<b>CUSTOMER HELP.....</b>	<b>12</b>
<i>General.....</i>	<i>12</i>
<i>Submitting a question.....</i>	<i>12</i>
<i>Downloads.....</i>	<i>12</i>
<b>FLIR A68/A38 SERIES OVERVIEW.....</b>	<b>13</b>
DESCRIPTION.....	13
<i>Key Features.....</i>	<i>13</i>
<i>Teledyne DALSA Development Software.....</i>	<i>14</i>
MODEL PART NUMBERS.....	14
<i>FLIR A68 Part Numbers.....</i>	<i>14</i>
<i>FLIR A38 Part Numbers.....</i>	<i>14</i>
EXPORT CONTROLS.....	15
FLIR A68/A38 SERIES SPECIFICATIONS.....	16
A68/A38 SERIES EMI, SHOCK AND VIBRATION CERTIFICATIONS.....	17
GIGE VISION INTERFACE.....	18
<i>GigE Vision Sopera Application Description.....</i>	<i>18</i>
GIGE NETWORK ADAPTER OVERVIEW.....	19
<i>PAUSE Frame Support.....</i>	<i>19</i>
COMPUTER REQUIREMENTS FOR FLIR A68/A38 SERIES.....	19
<i>Host PC System.....</i>	<i>19</i>
<i>Software Requirements.....</i>	<i>20</i>
<i>Ethernet Switch Requirements for FLIR A68/A38 Series.....</i>	<i>21</i>
<i>Ethernet to Fiber-Optic Interface Requirements.....</i>	<i>22</i>
<b>INTRODUCTION TO MICROBOLOMETERS.....</b>	<b>23</b>
<i>Emissivity.....</i>	<i>24</i>
<b>QUICK START GUIDE.....</b>	<b>26</b>
CONNECTING THE FLIR A68/A38 SERIES GIGE VISION CAMERA.....	26
<i>FLIR A68/A38 Series Power Specifications.....</i>	<i>26</i>
<i>Steps for Camera Startup.....</i>	<i>26</i>
<i>FLIR A68/A38 Series Connectors.....</i>	<i>27</i>
<i>Preventing Operational Faults due to ESD.....</i>	<i>27</i>
<i>A68/A38 IP Configuration Sequence.....</i>	<i>28</i>
CAMERA CONNECTION SETUP.....	29
<i>Displaying Images.....</i>	<i>30</i>
CONTROLLING A68/A38 USING THE SAPERA LT API.....	33
<b>FEATURES AND CONFIGURATION OPTIONS.....</b>	<b>35</b>
HEAT SINKS.....	36

ADJUSTING THE LENS FOCUS .....	36
LED INDICATORS.....	37
<i>FLIR A68/A38 Series LED States</i> .....	37
FIXED PATTERN NOISE CORRECTION .....	38
<i>Target Mode</i> .....	38
<i>Saving Fixed Pattern Noise Calibration</i> .....	39
<i>Performing Manual FPN Correction with Internal Shutter</i> .....	39
<i>Performing Manual FPN Correction with External Shutter</i> .....	40
<i>FPN Correction Using Triggered Acquisition</i> .....	42
<i>Automatic FPN Calibration</i> .....	42
<i>Performing Calibration of the Supplemental FPN Correction Table</i> .....	43
<i>Related GigE Vision Features</i> .....	43
RADIOMETRY .....	44
<i>Converting Pixel Values to Temperatures</i> .....	44
<i>Mounting and Thermal Considerations</i> .....	46
<i>Using Enclosures</i> .....	49
<i>Radiometric Calibration</i> .....	50
OVERLAYS .....	57
<i>Related GigE Vision Features</i> .....	58
FALSE COLOR MAPPING.....	59
<i>Related GigE Vision Features</i> .....	59
METADATA.....	60
<i>Related GigE Vision Features</i> .....	62
PIXEL POLARITY.....	63
<i>Related GigE Vision Features</i> .....	63
DEFECTIVE PIXEL CORRECTION.....	64
<i>Related GigE Vision Features</i> .....	65
MEDIAN FILTER .....	66
<i>Related GigE Vision Features</i> .....	66
CONTRAST ENHANCEMENT.....	67
<i>Contrast Mode</i> .....	67
<i>Related GigE Vision Features</i> .....	76
CAMERA SYNCHRONIZATION .....	77
<i>Slave Configuration with External Input Frame Trigger</i> .....	78
<i>Slave Configuration with PTP Trigger</i> .....	78
<i>Master Configuration with Output Pulses</i> .....	79
<i>Related GigE Vision Features</i> .....	79
EXTERNAL TRIGGER .....	80
SENSOR READOUT ALIGNMENT MODE .....	82
<i>Related GigE Vision Features</i> .....	84
PRECISION TIME PROTOCOL .....	85
<i>PTP Synchronization</i> .....	85
<i>Hardware Considerations</i> .....	85
<i>PTP Configuration Features</i> .....	86
<i>Related GigE Vision Features</i> .....	86
INTERNAL TEST PATTERN GENERATOR.....	87
<i>A68/A38 Test Patterns</i> .....	87
<i>Related GigE Vision Features</i> .....	88
TEMPERATURE SENSORS .....	89
<i>Related GigE Vision Features</i> .....	89
ERROR LOG FILE.....	90
<i>Related GigE Vision Features</i> .....	90
<b>OPERATIONAL REFERENCE.....</b>	<b>91</b>
<b>USING A FLIR A68/A38 SERIES CAMERA WITH SAPERA API.....</b>	<b>91</b>
<i>Network and Computer Overview</i> .....	91
<i>Installing Sapera LT</i> .....	92

<i>Camera Firmware Updates</i> .....	92
<i>Firmware via Linux or Third-Party Tools</i> .....	92
<i>GigE Server Verification</i> .....	93
<i>GigE Server Status</i> .....	93
<i>Optimizing the Network Adapter used with A68/A38</i> .....	94
<i>Quick Test with CamExpert (Windows)</i> .....	94
<i>About the Device User ID</i> .....	95
USING CAMEXPERT WITH A68/A38 CAMERAS .....	96
<i>CamExpert Panes</i> .....	96
CAMERA INFORMATION CATEGORY .....	99
<i>Camera Information Feature Descriptions</i> .....	100
<i>Power-up Configuration Dialog</i> .....	102
IMAGE FORMAT CONTROLS CATEGORY .....	103
<i>Image Format Controls Feature Descriptions</i> .....	103
FPN CORRECTION CATEGORY .....	105
<i>FPN Correction Feature Descriptions</i> .....	106
CONTRAST / BRIGHTNESS / RADIOMETRY CATEGORY .....	109
<i>Contrast / Brightness / Radiometry Feature Descriptions</i> .....	109
IMAGE PROCESSING CATEGORY .....	112
<i>Image Processing Feature Descriptions</i> .....	112
OVERLAY CONTROL CATEGORY .....	115
<i>Overlay Feature Descriptions</i> .....	115
ACQUISITION CONTROL CATEGORY .....	117
<i>Acquisition Control Feature Descriptions</i> .....	117
<i>Features that Cannot be Changed During a Transfer</i> .....	119
TRIGGER CONTROL FEATURES CATEGORY .....	120
<i>Trigger Controls Feature Descriptions</i> .....	120
<i>Examples using Timestamp Modulo Event for Acquisitions</i> .....	122
I/O CONTROLS CATEGORY .....	126
<i>I/O Controls Feature Descriptions</i> .....	126
EVENT CONTROL CATEGORY .....	128
<i>Event Control Feature Descriptions</i> .....	128
<i>Overview of Precision Time Protocol Mode (IEEE 1588)</i> .....	134
USER SET CONTROL CATEGORY .....	136
<i>User Set Control Feature Descriptions</i> .....	136
METADATA CONTROLS CATEGORY .....	137
<i>Metadata Controls Feature Descriptions</i> .....	137
GIGE VISION TRANSPORT LAYER CATEGORY .....	138
GIGE VISION HOST CONTROL CATEGORY .....	141
FILE ACCESS CONTROL CATEGORY .....	141
<b>TECHNICAL SPECIFICATIONS</b> .....	<b>144</b>
MECHANICAL SPECIFICATIONS .....	144
<i>FLIR A68/A38 Series with M25 Lens Mount</i> .....	144
ADDITIONAL NOTES ON A68/A38 IDENTIFICATION AND MECHANICAL .....	145
CONNECTORS .....	145
<i>10-pin I/O Connector Details</i> .....	145
<i>Input Signal Electrical Specifications</i> .....	146
<i>Power over Ethernet (PoE) Support</i> .....	149
<i>Output Signals Electrical Specifications</i> .....	149
ADDITIONAL REFERENCE INFORMATION .....	153
<i>I/O Mating Connector Sources</i> .....	153
RUGGEDIZED RJ45 ETHERNET CABLES .....	154
SENSOR HANDLING INSTRUCTIONS .....	155
<i>Cleaning the Sensor Window</i> .....	155
<i>Electrostatic Discharge and the Sensor</i> .....	155

<b>DECLARATIONS OF CONFORMITY .....</b>	<b>156</b>
<i>FCC Statement of Conformance .....</i>	<i>156</i>
<i>EU and UKCA Declaration of Conformity .....</i>	<i>156</i>
<b>TROUBLESHOOTING .....</b>	<b>157</b>
OVERVIEW .....	157
QUICK RECOVERY GUIDE .....	157
GENERAL TROUBLESHOOTING FOR FLIR A68/A38 SERIES .....	159
<i>Error Log File.....</i>	<i>159</i>
<i>Power Failure During a Firmware Update–Now What? .....</i>	<i>159</i>
<i>Power supply problems: .....</i>	<i>159</i>
<i>Camera is functional, but image has no contents.....</i>	<i>159</i>
FLIR A68/A38 SERIES TROUBLESHOOTING .....	159
<i>GigE Server Status .....</i>	<i>159</i>
<i>Problem Type Summary.....</i>	<i>161</i>
<i>Acquisition Error without Timeout Messages .....</i>	<i>163</i>
<i>Cabling and Communication Problems: .....</i>	<i>164</i>
<i>Verifying Network Parameters.....</i>	<i>165</i>
INTERNAL SHUTTER PROBLEMS .....	166

# Figures

Figure 1: GigE Application Architecture .....	18
Figure 2: FLIR A68/A38 Series– Rear View .....	27
Figure 3: Lens Lockdown Screws .....	36
Figure 4: FLIR A68/A38 Series LED Startup Sequence.....	37
Figure 5: FPN Compensation Mode .....	39
Figure 6: Performing FPN Correction .....	40
Figure 7: Faulty FPN Calibration .....	41
Figure 8: Color Map Overlay .....	46
Figure 9: Mechanical camera interface (left) used for thermal coupling during mounting on heatsink (right) .....	46
Figure 10: Camera Mounted on Tripod .....	47
Figure 11: Camera Schematic Showing Flux Contribution: Red = internal housing contribution, Green = useful IR flux part coming from the scene through the lens .....	47
Figure 12: Influence of Airflow on Temperature Accuracy .....	48
Figure 13: Camera in Enclosure Configuration (with and w/o window) .....	49
Figure 14: Temperature Accuracy Improvement Using an Enclosure .....	49
Figure 15: Gain feature for external optic adjustment. ....	53
Figure 16: Radiometric Offset Correction Feature .....	55
Figure 17: Temperature Accuracy (25°C & 40°C target objects) Using 35°C External Reference (IEC80601-2-59 requirements) .....	55
Figure 18: Overlay feature setup for external reference .....	56
Figure 19: Radiometry features setup for external reference.....	56
Figure 20: Overlays .....	57
Figure 21: Fire Color Map .....	59
Figure 22: Fire Color Map Range Overlay.....	59
Figure 23: Pixel Polarity .....	63
Figure 24: Defective Pixel Map.....	64
Figure 25: File Access Control.....	65
Figure 26: Median Filter .....	66
Figure 27: Contrast Enhancement Mapping 16-Bit to 8-bit.....	67
Figure 28: Dynamic Adaptive Image Enhancement.....	68
Figure 29: Contrast Enhancement Maximum Gain .....	70
Figure 30: Fixed Adaptive Image Enhancement.....	72
Figure 31: Fixed Adaptive Brightness Setting .....	73
Figure 32: Fixed Adaptive Brightness Setting Example .....	73
Figure 33: External Trigger Wave Diagram: Free-Running .....	83
Figure 34: External Trigger Wave Diagram: Frame-On-Demand .....	84
Figure 35: Horizontal Ramp Test Pattern .....	87
Figure 36: Vertical Ramp Test Pattern.....	87
Figure 37: Diagonal Ramp Test Pattern .....	87
Figure 38: File Access Control Dialog .....	88
Figure 39: File Access Control Dialog .....	90
Figure 40: GigE Server Tray Icon .....	93
Figure 41: GigE Pop-up Menu .....	93
Figure 42: GigE Vision Device Status .....	94
Figure 43: Sapera CamExpert.....	95
Figure 44: Sapera CamExpert GUI Layout .....	97
Figure 45: CamExpert Camera Information Category .....	99
Figure 46: Power-up Configuration Dialog .....	102
Figure 47: CamExpert Image Format Controls .....	103
Figure 48: CamExpert FPN Correction Category .....	105



Figure 49: CamExpert Contrast / Brightness/ Radiometry Category .....	109
Figure 50: CamExpert Image Processing Category.....	112
Figure 51: CamExpert Overlay Category .....	115
Figure 52: CamExpert Acquisition Control.....	117
Figure 53: CamExpert Trigger Control Features Category .....	120
Figure 54: CamExpert I/O Controls Category .....	126
Figure 55: CamExpert Event Control Category .....	128
Figure 56: CamExpert User Set Control Category .....	136
Figure 57: CamExpert Metadata Controls .....	137
Figure 58: CamExpert GigE Vision Transport Layer Category .....	138
Figure 59: CamExpert File Access Control Category .....	141
Figure 60: CamExpert File Access Control Category .....	143
Figure 61: FLIR A68/A38 Series with M25 Lens Mount (mm units).....	144
Figure 62: Ruggedized RJ45 Ethernet cable with Thumbscrews .....	154
Figure 63: Random Bad Data or Noise Example .....	163

# Tables

<i>Table 1: Teledyne DALSA Development Software</i>	14
<i>Table 2: FLIR A68/A38 Series Specifications</i>	16
<i>Table 3: FLIR A68/A38 Series EMI, Shock and Vibration Certifications</i>	17
<i>Table 4: Emissivity Values for Common Materials</i>	25
<i>Table 5: FLIR A68/A38 Series Power Specifications</i>	26
<i>Table 6: Bit Range for 16-Bit Image Display</i>	31
<i>Table 7: Image Display Using Different 8-Bit Ranges</i>	31
<i>Table 8: FLIR A68/A38 Series LED States</i>	37
<i>Table 9: Image Enhancement Dynamic Adaptive Contrast Examples</i>	69
<i>Table 10: Maximum Gain Off Example</i>	71
<i>Table 11: Maximum Gain Setting Examples</i>	71
<i>Table 12: Maximum Gain Setting 0.5 Example</i>	72
<i>Table 13: Sample 16-Bit Image</i>	74
<i>Table 14: Static Contrast Mode Example</i>	75
<i>Table 15: GigE Server Tray Icon States</i>	93
<i>Table 16: CamExpert Display Pane Control Buttons</i>	96
<i>Table 17: Camera Information Feature Descriptions</i>	100
<i>Table 18: Image Format Controls Feature Descriptions</i>	103
<i>Table 19: Image Processing Feature Descriptions</i>	106
<i>Table 20: Contrast / Brightness /Radiometry Feature Descriptions</i>	109
<i>Table 21: Image Processing Feature Descriptions</i>	112
<i>Table 22: Overlay Feature Descriptions</i>	115
<i>Table 23: Acquisition Control Feature Descriptions</i>	117
<i>Table 24: Trigger Control Controls Feature Descriptions</i>	120
<i>Table 25: I/O Controls Feature Descriptions</i>	126
<i>Table 26: Event Control Feature Descriptions</i>	128
<i>Table 27: User Set Control Feature Descriptions</i>	136
<i>Table 28: Metadata Controls Feature Descriptions</i>	137
<i>Table 29: GigE Vision Transport Layer Feature Descriptions</i>	139
<i>Table 30: File Access Control Feature Descriptions</i>	142
<i>Table 31: Samtec 10-Pin Connector Pin Assignment</i>	145
<i>Table 32: GigE Server Tray Icon States</i>	159

# Notice to User

## Disposal of electronic waste

Electrical and electronic equipment (EEE) contains materials, components and substances that may be hazardous and present a risk to human health and the environment when waste electrical and electronic equipment (WEEE) is not handled correctly.

For this purpose all local authorities have established collection schemes under which residents can dispose waste electrical and electronic equipment at a recycling centre or other collection points, or WEEE will be collected directly from households. More detailed information is available from the technical administration of the relevant local authority.

## Training

For training resources and courses, go to <http://www.flir.com/support-center/training>.

## Documentation updates

Our manuals are updated several times per year, and we also issue product-critical notifications of changes on a regular basis.

To access the latest manuals, translations of manuals, and notifications, go to the Download tab at:

<http://support.flir.com>

In the download area you will also find the latest releases of manuals for our other products, as well as manuals for our historical and obsolete products.

## Note about authoritative versions

The authoritative version of this publication is English. In the event of divergences due to translation errors, the English text has precedence. Any late changes are first implemented in English.

# Customer Help

## General

Do not hesitate to contact our Customer Support Center if you experience problems or have any questions.

For customer help, go to <http://support.flir.com>

## Submitting a question

To submit a question to the customer help team, you must be a registered user. It only takes a few minutes to register online. If you only want to search the knowledgebase for existing questions and answers, you do not need to be a registered user.

When you want to submit a question, make sure that you have the following information to hand:

- The camera model.
- The camera serial number.
- The communication protocol, or method, between the camera and your device (e.g., SD card reader, HDMI, Ethernet, USB, or FireWire).
- Device type (PC/Mac/iPhone/iPad/Android device, etc.).
- Version of any programs from FLIR Systems.
- Full name, publication number, and revision number of the manual.

## Downloads

On the customer help site you can also download the following, when applicable for the product:

- Firmware updates for your infrared camera.
- Program updates for your PC/Mac software.
- Freeware and evaluation versions of PC/Mac software.
- User documentation for current, obsolete, and historical products.
- Mechanical drawings (in \*.dxf and \*.pdf format).
- CAD data models (in \*.stp format).
- Application examples.
- Technical datasheets.

# FLIR A68/A38 Series Overview

---

## Description

The FLIR A68/A38 series cameras are small form factor long wave infrared cameras. The FLIR A68/A38 Series cameras are based on Teledyne DALSA detector technology.

The camera is available in two resolutions, VGA (640x480) and QVGA (320x240).

The FLIR A68/A38 series cameras features an internal mechanical shutter; this allows the camera to recalibrate itself upon demand during operation. This ensures uniform image output regardless of the camera's thermal environment. Note that factory calibration of the A68/A38 cameras allows them to operate for a long period of time before shutter may need to be activated.

This manual describes features available for the FLIR A68/A38 series firmware release 2.51.

## Key Features

- 640x480 VGA or 320x240 QVGA resolutions
- 17  $\mu\text{m}$  square pixels
- 29mm x 36mm x 59mm
- Gigabit Ethernet (GigE) interconnection to a computer via standard 1000BASE-T compliant cables
- Visual camera multicolor status LED on back plate
- General purpose opto-coupled input allows frame acquisition using an external trigger
- General purpose opto-coupled output (user, count, alarm or timer driven triggering)
- Counter function available based on general purpose opto-coupled input
- Defective pixel replacement
- Adaptive contrast enhancement
- Digital zoom (1x, 2x, 4x, 8x or 16x)
- Supports image timestamp based on IEEE1588-2008 Precision Time Protocol for synchronization between multiple cameras
- Built-in pseudo-color for enhanced visualization
- Image metadata supported
- Application development with the freely available Sopera™ LT software libraries
- Internal mechanical shutter for remote recalibration
- Made in Canada

Camera features can be controlled using a GigE Vision compliant software API, such as Teledyne DALSA's Sopera LT SDK. Within the Sopera LT SDK, we currently offer a generic GigE Vision driver that supports all Teledyne DALSA GigE Vision cameras, including all future A68/A38 GigE Vision cameras.

The **Sapera LT** initial version that supports this driver is **Sapera LT v7.30**. We strongly recommend using **v8.41 or greater** for an improved user experience. Sapera LT is available for download from the Teledyne DALSA website:

<http://www.teledynedalsa.com/imaging/support/downloads/sdks/>

## Teledyne DALSA Development Software

Table 1: Teledyne DALSA Development Software

Teledyne DALSA Software Platform for Microsoft Windows	
Sapera LT version 8.41 or greater (for Windows) includes Sapera Network Imaging Package and GigE Vision Imaging Driver, Sapera Runtime and CamExpert. Provides everything you will need to develop imaging applications Sapera documentation in compiled HTML help, and Adobe Acrobat® (PDF)	Available for download: <a href="https://www.teledynedalsa.com/en/support/options/">https://www.teledynedalsa.com/en/support/options/</a>
Sapera Processing Imaging Development Library (available for Windows or Linux - sold separately):	Contact Teledyne DALSA Sales
Teledyne DALSA Software Platform for Linux	
GigE Vision Framework (for both X86 or Arm type processor)	Contact Teledyne DALSA Sales

## Model Part Numbers

The following tables lists the available part numbers, where:

- EFL = Effective Focal Length
- HFOV = Horizontal Field of View
- VFOV = Vertical Field of View

### FLIR A68 Part Numbers

Part #	Lens Mount	EFL (mm)	Aperture (1/f)	HFOV (degrees)	VFOV (degrees)	Minimum working distance (approx. <sup>1</sup> )	Lens Weight (grams)	Total Weight (grams)	Length with lens
11302-0102	M25	14.2	1.2	42.1	31.9	1.3 m	25	92.1	69 mm
11302-0101	M25	25	1.2	24.2	18.4	2 m	4	71.2	80 mm

1. Smaller working distances are possible but optical performance may be affected.

### FLIR A38 Part Numbers

Part #	Lens Mount	EFL (mm)	Aperture (1/f)	HFOV (degrees)	VFOV (degrees)	Minimum working distance (approx. <sup>1</sup> )	Lens Weight (grams)	Total Weight (grams)	Length with lens
11301-0102	M25	8.1	1.1	40.1	29.5	1.5 m	27	94.2	70
11301-0101	M25	13	1.0	24.1	18.1	0.4m	23	90.2	69

1. Smaller working distances are possible but optical performance may be affected.

For ordering information, contact your Teledyne FLIR sales representative.

---

## **Export Controls**

The FLIR A68/A38 series cameras are currently classified as a "Dual Use" item under Group 1 (1-6.A.3.B.4.B) of the Canada Export Control List and Category 6 (6.A.3.B.4) under the Wassenaar Arrangement on Export Control for Conventional Arms and Dual-Use Goods and Technologies.

# FLIR A68/A38 Series Specifications

The FLIR A68/A38 Series camera has the following specifications:

Table 2: FLIR A68/A38 Series Specifications

Mechanical Interface		
Camera with M25 Lens Mount (W x H x L)	29mm x 36mm x 59mm (with lens mount)	
Mass (without lens)	67.2 g	
<a href="#">Power connector</a>	via Samtec 10-pin connector (or optionally using Power-over-Ethernet)	
Electrical Interface		
Input Voltage	12/24V DC (min 9V, max 57V)	
Power Consumption, for different power supply configurations:	Typical	Peak (usually due to shutter activation)
12 V	2.8 W	4.4 W
24 V	2.8 W	4.4 W
Power over Ethernet (48V)	3.5 W	4.8 W
Environmental Conditions		
Operating Temperature (Ambient) <sup>1</sup>	-35°C to 60°C <sup>1</sup>	
Operating Relative Humidity	maximum 80% non-condensing	
Storage Temperature <sup>2</sup>	-40°C to +80°C	
Storage Relative Humidity	maximum 80% non-condensing	
Sensor Information		
Spectral Response	8-14µm (LWIR)	
Pixel Pitch	17µm	
Focal Plane Array	640x480 (VGA) or 320x240 (QVGA)	
Camera Information		
Boot time	7.5s ± 1s (from power-up to detection by Sopera LT library running on Windows using Persistent IP address)	
Internal mechanical shutter activation time	<100ms to change from open/closed position	
NETD <sup>3</sup>	Scene Range (°C)	
<50 mK	-25 to 200	

1. Extended or limited operating temperature ranges are available; contact Teledyne FLIR for more information.
2. To avoid possible damage, when storing cameras, ensure that the sensor is not exposed to air; use a lens cap or lens to cover the sensor.
3. Camera NETD measures the actual noise in output images, using an f/1.0 lens, with processing, at 30fps.



**WARNING:** These sensors are sensitive to over-exposure to hot objects; the sensors are considered “sun-safe” in the sense that pixels will not break if over exposed for short periods; however, long exposure to hot bodies (like the sun) will eventually create ghost-like artifacts. These artifacts can be made to disappear by recalibrating the FPN compensation (see [Fixed Pattern Noise Correction](#)).

**WARNING:** For cameras not equipped with a lens, do not touch the internal mechanical shutter; any physical contact to the shutter may render it unusable.



# A68/A38 Series EMI, Shock and Vibration Certifications



Table 3: FLIR A68/A38 Series EMI, Shock and Vibration Certifications

Test Name / Standard	Limit / Test Level									
Measurement of conducted emissions CISPR 11: 2015 A1: 2016 A2: 2019	Group1, Class A									
Measurement of radiated emissions CISPR 11: 2015 A1: 2016 A2: 2019	Group1, Class A									
Measurement of conducted emissions - LAN port CISPR 32: 2015	Class A									
Measurement of conducted emissions FCC Part 15: 2018, Subpart B	Class A									
Measurement of radiated emissions FCC Part 15: 2018, Subpart B	Class A									
Radiated electromagnetic field immunity – radio frequencies IEC 61000-4-3: 2006 A1: 2007 A2: 2010	Scan 10 V/m 80-1000 MHz 3 V/m 1.4-2.7 GHz Spot 3 V/m 1.8, 2.6, 3.5 and 5 GHz									
Conducted immunity IEC 61000-4-6: 2013	10 V power 10 V I/O									
Electrostatic discharge immunity IEC 61000-4-2: 2008	±4 kV contact ±8 kV air									
Electrostatic fast transient immunity IEC 61000-4-4: 2012	±2 kV power ±1 kV I/O									
Surge immunity IEC 61000-4-5: 2014 A1: 2017	±1 kV L - L ±2 kV L - Ground									
Magnetic field immunity IEC 61000-4-8: 2009	30 A/m / 50 Hz									
Voltage dips, short interruptions and voltage variation immunity IEC 61000-4-11: 2004 A1: 2017	0% - 1 cycle 40% - 10 cycles 70% - 25 cycles 0% - 250 cycles									
<b>RoHS</b>	Compliance as per European directive 2011/65/EC									
<b>Vibration &amp; Shock Tests</b>										
<b>Random vibrations</b>	<table border="1"> <thead> <tr> <th>Test Levels (while operating)</th> <th>Test Parameters</th> </tr> </thead> <tbody> <tr> <td>Level 1: 2 grms 60 min.</td> <td rowspan="6">Frequency range: 20 to 2000 Hz Directions: X, Y, and Z axis</td> </tr> <tr> <td>Level 2: 4 grms 45 min.</td> </tr> <tr> <td>Level 3: 6 grms 30 min.</td> </tr> <tr> <td>Level 4: 7.7 grms 60 min</td> </tr> <tr> <td>Level 5: 15 grms 30 min</td> </tr> <tr> <td>Level 6: 20 grms 30 min</td> </tr> </tbody> </table>	Test Levels (while operating)	Test Parameters	Level 1: 2 grms 60 min.	Frequency range: 20 to 2000 Hz Directions: X, Y, and Z axis	Level 2: 4 grms 45 min.	Level 3: 6 grms 30 min.	Level 4: 7.7 grms 60 min	Level 5: 15 grms 30 min	Level 6: 20 grms 30 min
Test Levels (while operating)	Test Parameters									
Level 1: 2 grms 60 min.	Frequency range: 20 to 2000 Hz Directions: X, Y, and Z axis									
Level 2: 4 grms 45 min.										
Level 3: 6 grms 30 min.										
Level 4: 7.7 grms 60 min										
Level 5: 15 grms 30 min										
Level 6: 20 grms 30 min										
<b>Shocks</b>	<table border="1"> <thead> <tr> <th>Test Levels (while operating)</th> <th>Test Parameters</th> </tr> </thead> <tbody> <tr> <td>Level 1: 20 g / 11 ms</td> <td rowspan="3">Shape: half-sine Number: 6 shocks (+) and 6 shocks (-) Directions: ±X, ±Y, and ±Z axis</td> </tr> <tr> <td>Level 2: 30 g / 11 ms</td> </tr> <tr> <td>Level 3: 40 g / 6 ms</td> </tr> </tbody> </table>	Test Levels (while operating)	Test Parameters	Level 1: 20 g / 11 ms	Shape: half-sine Number: 6 shocks (+) and 6 shocks (-) Directions: ±X, ±Y, and ±Z axis	Level 2: 30 g / 11 ms	Level 3: 40 g / 6 ms			
Test Levels (while operating)	Test Parameters									
Level 1: 20 g / 11 ms	Shape: half-sine Number: 6 shocks (+) and 6 shocks (-) Directions: ±X, ±Y, and ±Z axis									
Level 2: 30 g / 11 ms										
Level 3: 40 g / 6 ms										
<b>Thermal Shock</b>	-35°C - 65 °C (± 3 °C) 50 cycles									
<b>Additional information concerning test conditions and methodologies is available on request.</b>										

# GigE Vision Interface

FLIR A68/A38 series cameras comply with the GigE Vision and GenICam standard protocols.

## GigE Vision Sopera Application Description

	<p>A68/A38 cameras are 100% compliant with the GigE Vision 1.1 specification which defines the communication interface protocol used by any GigE Vision device. The device description and capabilities are contained in an XML file. For more information see: <a href="https://www.visiononline.org/vision-standards-details.cfm">https://www.visiononline.org/vision-standards-details.cfm</a></p>
	<p>A68/A38 cameras implement a superset of the GenICam™ specification which defines device capabilities. This description takes the form of an XML device description file respecting the syntax defined by the GenApi module of the GenICam™ specification. For more information see <a href="http://www.genicam.org">www.genicam.org</a>.</p>

The Teledyne DALSA GigE Vision Module provides a license free development platform for Teledyne GigE hardware or Sopera vision applications. Additionally supported are Sopera GigE Vision applications for third-party hardware with the purchase of a GigE Vision Module license, or the Sopera processing SDK with a valid license.

The GigE Vision Compliant XML device description file is embedded within A68/A38 firmware allowing GigE Vision Compliant applications access to A68/A38 capabilities and controls immediately after connection.

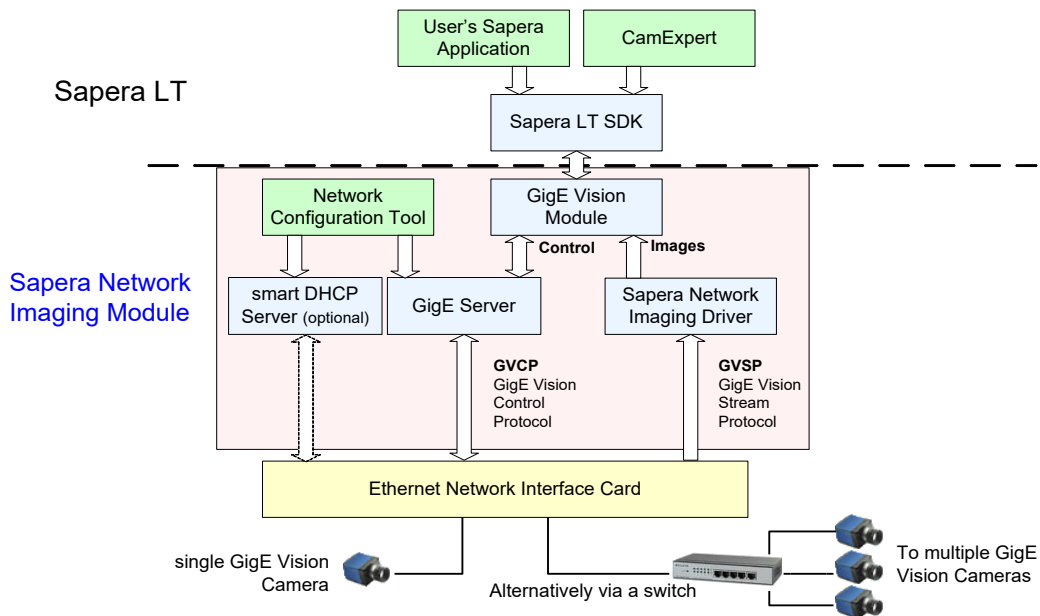

Figure 1: GigE Application Architecture

---

## GigE Network Adapter Overview

A68/A38 connects to a computer's Gigabit Network Adapter. If the computer is already connected to a network, the computer requires a second network adapter, either onboard or an additional PCIe NIC adapter.

In general, automatic IP configuration assignment (LLA/DHCP) is sufficient for most A68/A38 installations. Please refer to the **Teledyne DALSA Network Imaging Package manual** for information on the Teledyne DALSA Network Configuration tool and network optimization for GigE Vision cameras and devices.

### PAUSE Frame Support

The A68/A38 supports the Gigabit Ethernet PAUSE Frame feature as per IEEE 802.3x. PAUSE Frame is the Ethernet flow control mechanism to manage network traffic within an Ethernet switch when multiple cameras are simultaneously used. This requires that the flow control option in the NIC property settings and the Ethernet switch settings must be enabled. Refer to the Teledyne DALSA Network Imaging manual.

---

## Computer Requirements for FLIR A68/A38 Series

The following information is a guide to computer and networking equipment required to support the FLIR A68/A38 series camera at maximum performance. The A68/A38 camera series complies with the current IPv4 Internet Protocol, therefore current Gigabit Ethernet (GigE) equipment should provide trouble free performance.

### Host PC System

Operating Systems:

- Windows 7, 8.0, 8.1, 10 (either 32-bit or 64-bit for all) are supported.
- Linux supported by [Teledyne DALSA GigE-V Framework](#); for supported kernels and platforms refer to the GigE-V Framework documentation.

### Network Adapters for GigE Camera Version

- GigE network adapter (either add on card or on motherboard). The Intel PRO/1000 MT adapter is an example of a high-performance NIC. Typically a system will need an Ethernet GigE adapter to supplement the single NIC on the motherboard.
- PCI Express adapters will outperform PCI adapters.

### Laptop Information for GigE Camera Version

- Older laptop computers with built in GigE network adapters may still not be able to stream full frame rates from A68/A38. Thorough testing is required with any laptop computer to determine the maximum frame rate possible (refer to the Teledyne DALSA Network Imaging Package user's manual).

## Software Requirements

Camera features can be controlled using a GigE Vision compliant software API, such as Teledyne DALSA's Sopera LT SDK. The Sopera LT software suite includes the CamExpert tool that allows for quick configuration and evaluation of all Teledyne DALSA products. As such, it is recommended that users install the latest version of Sopera LT on the host computer for evaluation and development.



**Note:** While other software tools and SDKs support acquiring images from GigE cameras, Teledyne DALSA cannot provide support for their specific configurations.

The current release version of Sopera LT is available for download here:

<http://www.teledynedalsa.com/imaging/products/software/sopera/lt/download/>.

To install the Sopera Network Imaging Package, it is recommended that the installation be started locally instead of from a network location.

During the installation process, you are prompted to choose the Sopera LT acquisition components to install. Select the **GigE Vision cameras** option. This will install the GigE Vision Network Imaging Package on your system. Other packages may be installed as required.

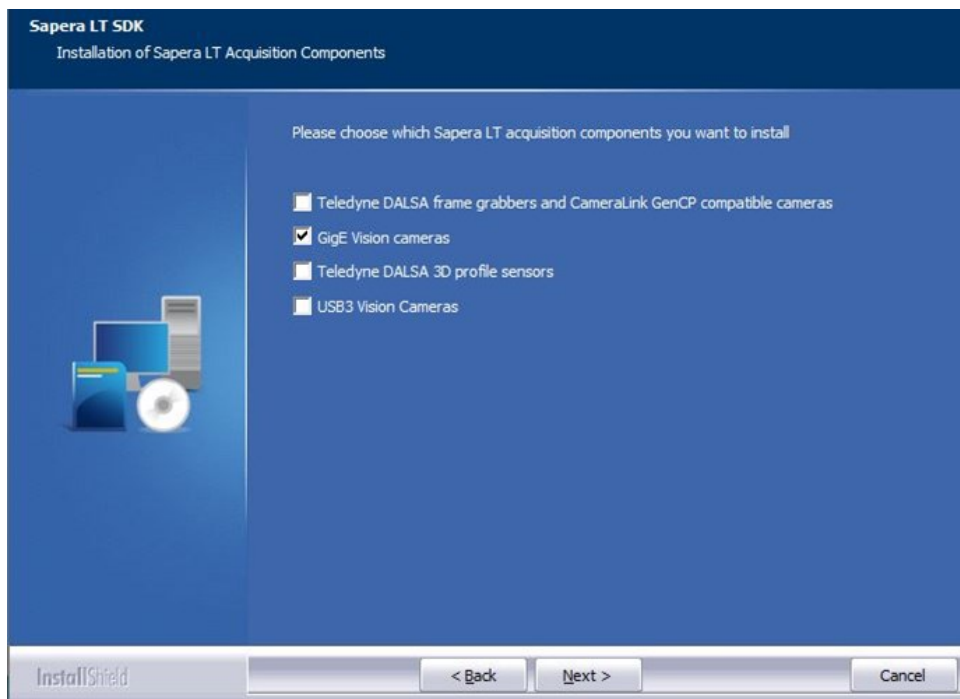

When upgrading from a previous version of Sopera LT this dialog is not displayed and the same directory structure and component configuration are used; however, when upgrading to Sopera LT 8.60 and higher it is displayed as new installation options are available.

While CamExpert can be used for evaluating a camera, an application typically uses the Spera LT API to configure the camera's parameters and acquire images. Sample applications are provided along with source code, to speed up application development. By default they are installed under the directory:

*C:\Program Files\Teledyne DALSA\Spera\Demos\*

Of particular interest is the *GigE Camera Demo* (available in pre-compiled form, with C++ and C# source projects). This project provides everything needed to acquire images from the camera. It can be easily modified to write required values to parameters (called 'features' in GenICam). For example, in C++ it can be implemented as:

```
m_AcqDevice->SetFeatureValue("PixelFormat", "Mono16");
```

## Ethernet Switch Requirements for FLIR A68/A38 Series

When there is more than one device on the same network or a camera-to-PC separation greater than 100 meters, an Ethernet switch is required. Since the FLIR A68/A38 series cameras comply with the Internet Protocol, they should work with all standard Ethernet switches. However, switches offer a range of functions and performance grades, so care must be taken to choose the right switch for a particular application.

### **IEEE 802.3x Pause Frame Flow Control**

Ethernet Switches supporting Full-duplex IEEE 802.3x Pause Frame Flow Control must be used in situations where multiple cameras may be triggered simultaneously. In such a case the NIC maximum bandwidth would be exceeded if there was no mechanism to temporarily hold back data from cameras. A68/A38 cameras support the IEEE 802.3x pause frame flow control protocol automatically so that images from many cameras can be transmitted through the switch to the NIC efficiently, without data loss. As a working example, one such switch tested at Teledyne DALSA is the NETGEAR GS716T.



Even if a given Ethernet switch supports Flow Control, often this feature is disabled in the switch configuration to provide best compatibility with older equipment. Please refer to the switch's documentation.

### **IEEE 1588 / PTP Transparent Mode**

GigE switches which support PTP Transparent mode will help reduce the variability of timestamp adjustments when cameras are synchronized with PTP/IEEE1588, but are not required.



**Important:** The maximum frame rate possible from a large number of A68/A38 cameras which are simultaneously triggered will depend on the A68/A38 model, frame size, and network details. Each imaging system should be tested for data rate limits.

## **Ethernet to Fiber-Optic Interface Requirements**

In cases of camera-to-PC separations of more than 100 meters but an Ethernet switch is not desired, a fiber-optic media converter can be used. The FlexPoint GX from Omnitron Systems ([www.omnitron-systems.com](http://www.omnitron-systems.com)) converts GigE to fiber transmission and vice versa. It supports multimode (MM) fiber over distances of up to 220 m (720 ft.) and single-mode (SM) fiber up to 65 km (40 mi.) with SC, MT-RJ, or LC connector types.

Important: The inclusion in this manual of GigE to fiber-optic converters does not guarantee they will meet specific application requirements or performance. The user must evaluate any supplemental Ethernet equipment.

# Introduction to Microbolometers

A microbolometer is an uncooled thermal sensor used as a detector in an infrared camera. FLIR A68/A38 series cameras are sensitive to thermal energy at long wave infrared (LWIR) wavelengths ranging from 8  $\mu\text{m}$  to 14  $\mu\text{m}$  (infrared wavelengths span from 710 nm – 1 millimeter). The FLIR A68/A38 series uses IR filtering lens that only allow these specific wavelengths to pass to the detector.

All objects emit electromagnetic radiation and the amount of radiation emitted at each wavelength depends on the temperature of the object. Hot objects emit at short wavelengths and cold objects emit more at long wavelengths.

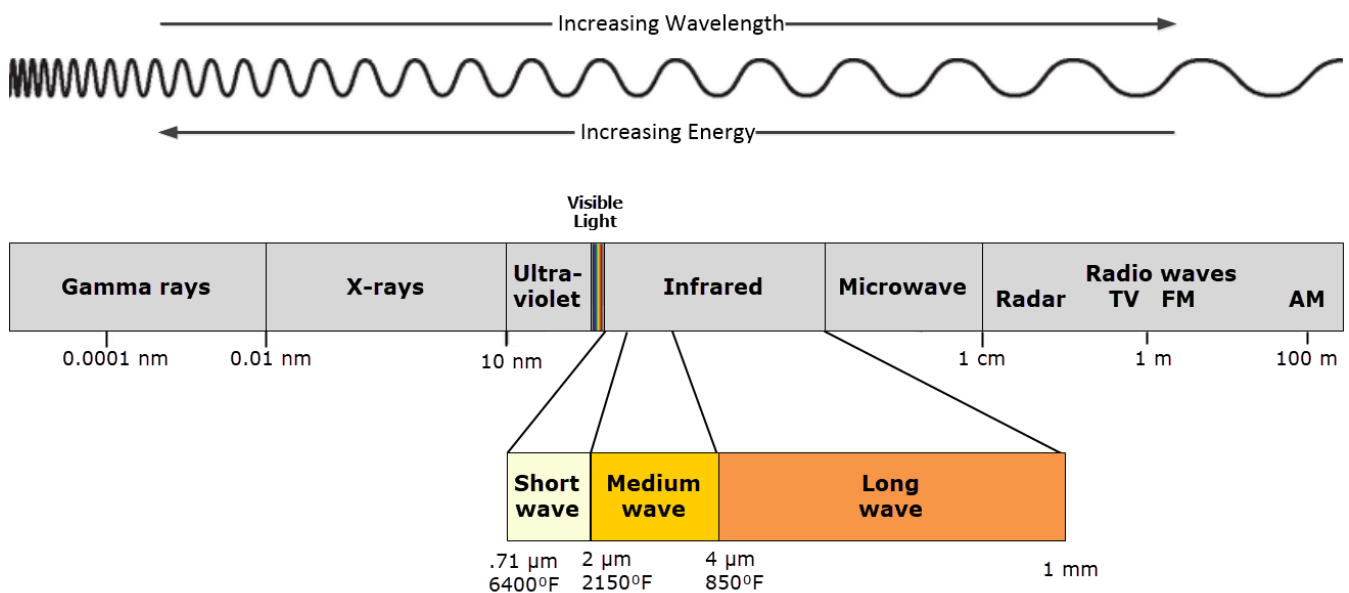

Infrared radiation strikes the detector material, heating it, and thus changing its electrical resistance. This resistance change is measured and an analog-to-digital converts the signal into a 16-bit value which is used to create an image. Unlike a traditional image sensor, there is no exposure time to fill a pixel well with photons; the microbolometer sensor is constantly exposed to incoming radiation and the readout circuit samples the pixel values to create the frame. When in free-running mode, the FLIR A68/A38 series reads frames at 30fps (this rate can be lowered by skipping frames or using one of the frame trigger modes).

The IR absorbing material is thermally isolated by suspending it within a vacuum, however it is still sensitive to changes in the camera body temperature.

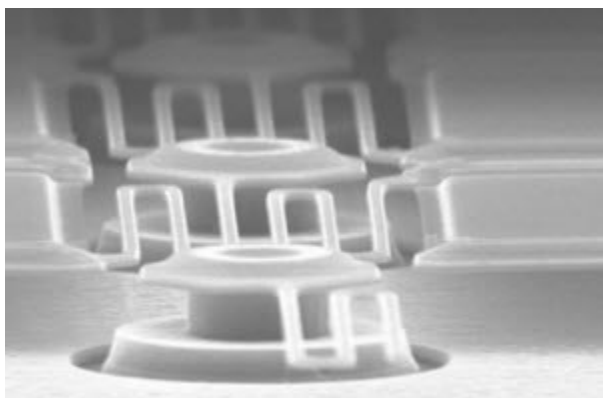

When the camera operating temperature changes, the FLIR A68/A38 series shutterless operation automatically compensates for the corresponding responsivity changes in the microbolometer pixel array (non-uniformity correction (NUC)). The NUC is factory calibrated across the working temperature range of the camera in free-running mode at 30fps.

However, if the thermo-mechanical environment of the camera changes from the factory calibration environment (for example, one side is exposed to heat or surface mounting conditions) the sensor [fixed pattern noise \(FPN\) correction](#) can be enabled to correct for these differences. If the camera temperature changes, or improved image quality is required, FPN correction can be recalculated to ensure optimal response.

## **Emissivity**

Emissivity is a measure of a material's ability to emit infrared energy. It is measured on a scale from 0.00 to 1.00. Typically, the closer a material's emissivity rating is to 1.00 (that is, 100%), the more that material tends to absorb reflected or ambient infrared energy and emit only its own infrared radiation. Most organic materials (for example, plants and animals), have an emissivity rating of 0.95.

Substances with very low emissivity ratings, like highly polished metals, tend to be very reflective of ambient infrared energy and less effective at emitting their own electromagnetic waves. For example, an object with an emissivity of 0.5, half the image pixel value is the result of the ambient temperature of the surrounding environment being reflected. Therefore, an understanding of target environments containing objects with emissivities of less than 0.7 is required to accurately analyze image scenes.



The following images demonstrate the effect of this reflected energy; depending on the angle, the stainless steel blade reflects the heat from the nearby hot object onto the IR sensor making it appear hotter than it actually is. Note that the reflection on the angled blade shows the difference in emissivity between the camera body and the Teledyne FLIR logo paint.

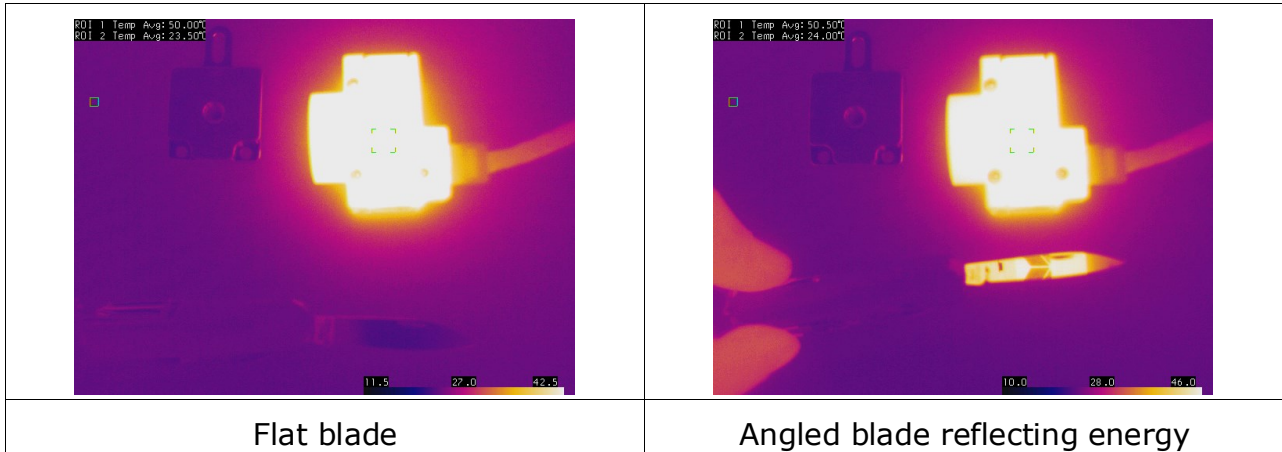

Emissivity tables for many types of material are available from a variety of sources. The following table lists approximate emissivity values for some common surfaces.

Table 4: Emissivity Values for Common Materials

Material	Emissivity
Aluminum, anodized	0.77
Aluminum, polished	0.05
Asphalt	0.88
Brick	0.90
Concrete, rough	0.91
Copper, polished	0.04
Copper, oxidized	0.87
Glass, smooth (uncoated)	0.95
Ice	0.97
Limestone	0.92
Marble (polished)	0.89 to 0.92
Paint (including white)	0.9
Paper, roofing or white	0.88 to 0.86
Plaster, rough	0.89
Sand	0.9
Silver, polished	0.02
Silver, oxidized	0.04
Skin (human)	0.98
Snow	0.8 to 0.9
Water	0.98

# Quick Start Guide

The quick start guide describes common operations such as how to connect FLIR A68/A38 series cameras, updating the camera firmware and performing manual fixed pattern noise (FPN) correction.

---

## Connecting the FLIR A68/A38 Series GigE Vision Camera

Connecting a A68/A38 to a network system is similar whether using the Teledyne DALSA Sopera LT package or a third-party GigE Vision development package. The computer requires an unused Ethernet Gigabit network interface (NIC).

The FLIR A68/A38 series camera can be powered through the I/O connector or by Power-over-Ethernet (PoE), if available, through the RJ-45 connector.

### FLIR A68/A38 Series Power Specifications

Before connecting power to the camera, test all power supplies. Power supplies must meet the following requirements:

Table 5: FLIR A68/A38 Series Power Specifications

Feature	Specification
DC Voltage	12V/24V (minimum 9V, maximum 57V)
Watts	4.4 W (peak consumption) / 4.8 W using PoE

### Steps for Camera Startup

- Apply power to the camera.
- Connect A68/A38 to the host computer GigE network adapter or to the Ethernet switch via a CAT5e or CAT6 Ethernet cable.
- Once communication with the host computer is started the automatic IP configuration sequence will assign an LLA IP address as described in section A68/A38 IP Configuration Sequence, or a DHCP IP address if a DHCP server is present on your network.
- Check the status LED which will be initially red then switch to flashing blue while waiting for IP configuration. See [LED Indicators](#) for A68/A38 LED display descriptions.
- The factory defaults for A68/A38 is Persistent IP disabled and DHCP enabled with LLA always enabled as per the GigE Vision specification.



**Note:** Cable should not be less than 1 meter (3 feet) long or more than 100 meters (328 feet) long, per GigE Vision standard.

## FLIR A68/A38 Series Connectors

The FLIR A68/A38 series has two connectors:

- **RJ45 Ethernet** connector for control and video data transmitted to/from the host computer Gigabit NIC. The A68/A38 also supports [Power Over Ethernet \(PoE\)](#).
- **10-pin I/O connector** for camera power (if not using PoE) and/or general purpose input and output pins. See [Connector Details](#) for connector pinout specifications.

The following figure of the FLIR A68/A38 series back end shows connector and LED locations (for a description of the possible LED states, refer to the FLIR A68/A38 series LED States section).

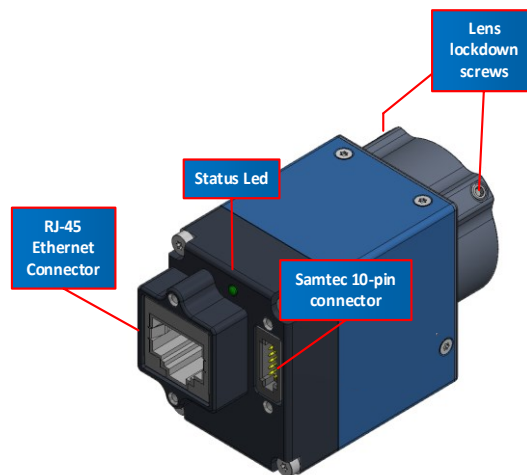

Figure 2: FLIR A68/A38 Series– Rear View

## Preventing Operational Faults due to ESD



A68/A38 camera installations which do not protect against ESD (electrostatic discharge) may exhibit operational faults. Problems such as random packet loss, random camera resets, and random loss of Ethernet connections, may all be solved by proper ESD management.

The A68/A38 camera, when used with a simple power supply and Ethernet cable, is not properly connected to earth ground and therefore is susceptible to ESD-caused problems. An Ethernet cable has no ground connection and a power supply's 0 volt return line is not necessarily connected to earth ground.

Teledyne FLIR has performed ESD testing on A68/A38 cameras using an +/-8kV air, +/-4kV contact ESD generator without any indication of operational faults. The following method will prevent ESD problems:

- Mount the camera on a metallic platform with a good connection to earth ground.

## A68/A38 IP Configuration Sequence

The A68/A38 GigE IP (Internet Protocol) configuration sequence to assign an IP address is executed automatically on camera power-up or when connected to a network. As a GigE Vision compliant device, A68/A38 attempts to assign an IP address as follows.

For any GigE Vision device, the IP configuration protocol sequence is:

- Persistent IP (if enabled)
- DHCP (if a DHCP server is present such as the Teledyne DALSA Smart DHCP server)
- Link-Local Address (always enabled as default)

### *Supported Network Configurations*

The A68/A38 obtains an IP address using the Link Local Address (LLA) or DHCP, by default. If required, a persistent IP address can be assigned (refer to the Network Imaging manual).

Preferably, a DHCP server is present on the network, where the A68/A38 issues a DHCP request for an IP address. The DHCP server then provides the A68/A38 an IP address. The **Teledyne DALSA Network Configuration tool**, installed with the Sopera Teledyne DALSA Network Imaging Package, provides a DHCP server which is easily enabled on the NIC used with the A68/A38 (refer to the Teledyne DALSA Network Imaging user's manual).

The LLA method, if used, automatically assigns the A68/A38 with a randomly chosen address on the 169.254.xxx.xxx subnet. After an address is chosen, the link-local process sends an ARP query with that IP onto the network to see if it is already in use. If there is no response, the IP is assigned to the device, otherwise another IP is selected, and the ARP is repeated. Note that the LLA mode is unable to forward packets across routers.

---

## Camera Connection Setup

- Connect A68/A38 to the spare NIC and wait for the GigE Server Icon in the Windows tray to show that the A68/A38 is connected.

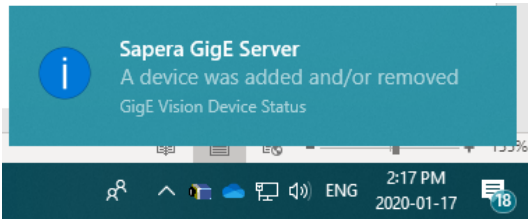

If the camera is not automatically detected, refer to the [Troubleshooting](#) section for possible solutions.

- The A68/A38 Status LED will be steady Blue.
- Start CamExpert. The A68/A38 Status LED will be steady light blue.
- Select the FLIR A68/A38 series camera using the Device Selector:

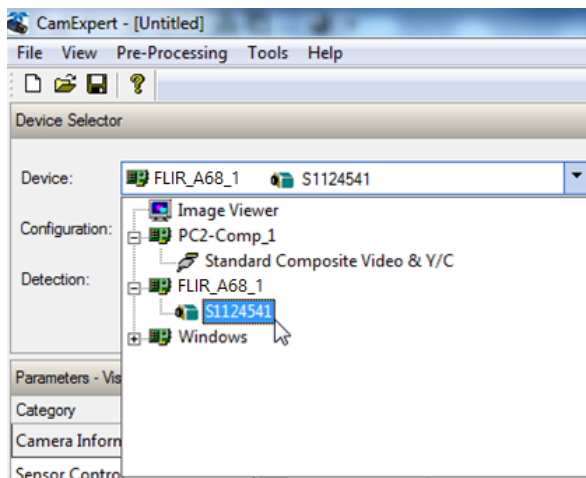

- Click the Grab button for live acquisition.

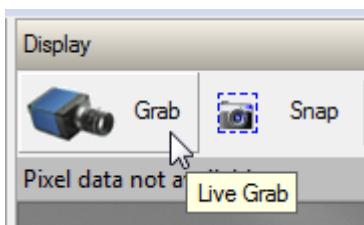

- Adjust the lens as required (if no lens is available, select a test pattern from the Image Format Controls category).
- If a firmware update is available for the camera see the Camera Firmware Updates section for information how to perform a firmware update.
- To obtain the best quality images possible, a single point fixed pattern noise (FPN) correction can be performed when the camera is at the required working temperature in the expected application environment. For more information on how to perform FPN correction, see the Fixed Pattern Noise Correction section.

## Displaying Images

The FLIR A68/A38 series sensor outputs 16-bit images, but these images cannot be displayed directly; for display they must be converted to 8-bit images. This can be done by the camera (see the [Contrast Enhancement](#) section) or by the host application.

### Displaying 16-bit Images

In CamExpert, under the Image Format Controls Category, select Pixel Format = Monochrome 16-Bit.

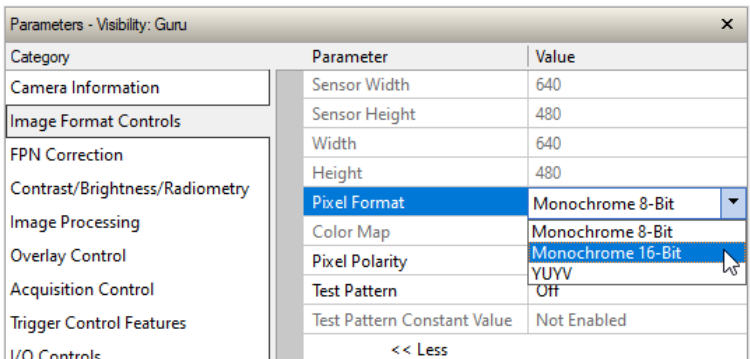

In this configuration, the A68/A38 camera outputs 16-bit images and it is the host application that is responsible for converting them to displayable 8-bit images.

To do so in CamExpert, right-click on the display window and select **Display Setting...**

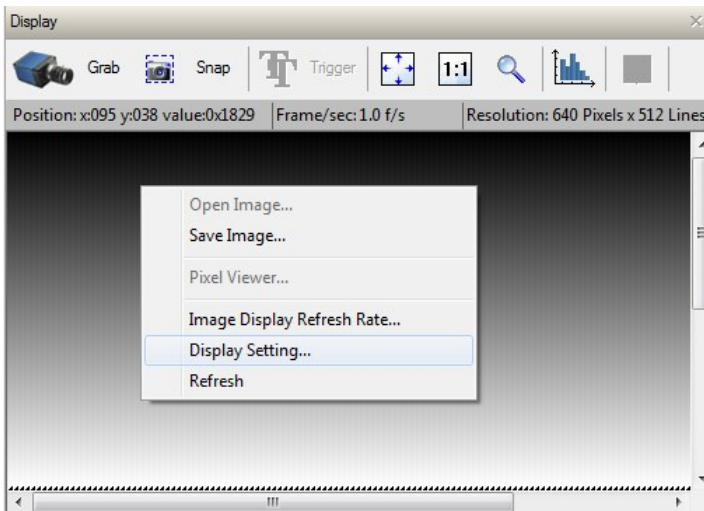

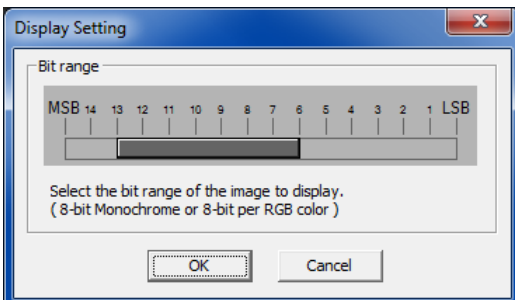

In the Display Setting dialog, use the slider to select the bit range to display.



For example, in the following image, the most relevant image data is contained in the bit range [9:2].

Table 6: Bit Range for 16-Bit Image Display

	
Bit range [15:8]	Bit range [9:2]

The histogram of a raw 16-bit image in Table 7 shows that the relevant information often resides in only a small segment of the overall dynamic range of the sensor. The following table provides image display examples of the different possible bit ranges.

Table 7: Image Display Using Different 8-Bit Ranges

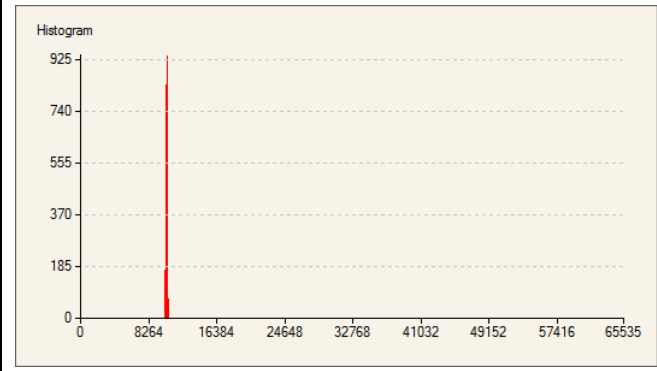
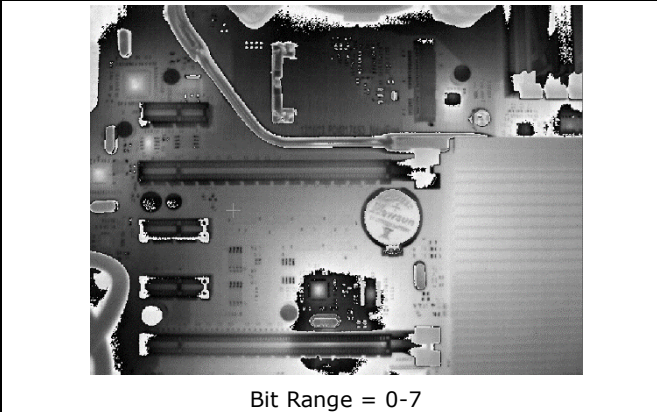
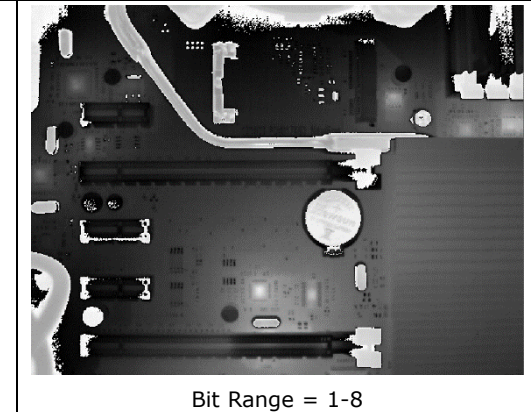
Original 16-bit image histogram											
	<table border="1"> <tr> <td>Minimum value:</td> <td>10010</td> </tr> <tr> <td>Maximum value:</td> <td>10485</td> </tr> <tr> <td>Max - Min :</td> <td>475</td> </tr> <tr> <td>Average value:</td> <td>10291.80</td> </tr> <tr> <td>Standard deviation:</td> <td>79.31</td> </tr> </table>	Minimum value:	10010	Maximum value:	10485	Max - Min :	475	Average value:	10291.80	Standard deviation:	79.31
Minimum value:	10010										
Maximum value:	10485										
Max - Min :	475										
Average value:	10291.80										
Standard deviation:	79.31										
Image Display Using Different 8-Bit Ranges											
 <p data-bbox="391 1832 566 1861">Bit Range = 0-7</p>	 <p data-bbox="997 1832 1173 1861">Bit Range = 1-8</p>										

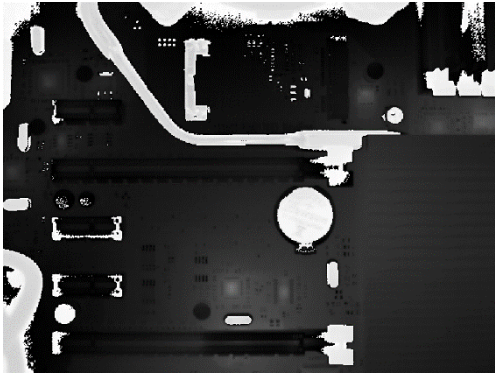

Bit Range = 2-9

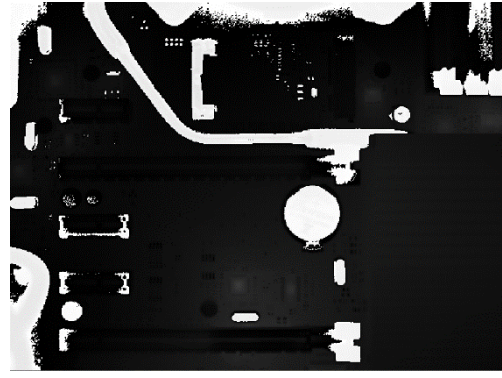

Bit Range = 3-10

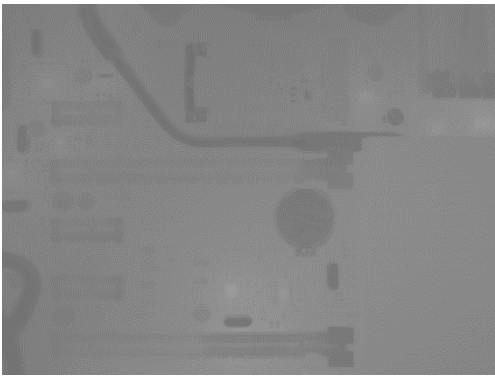

Bit Range = 4-11

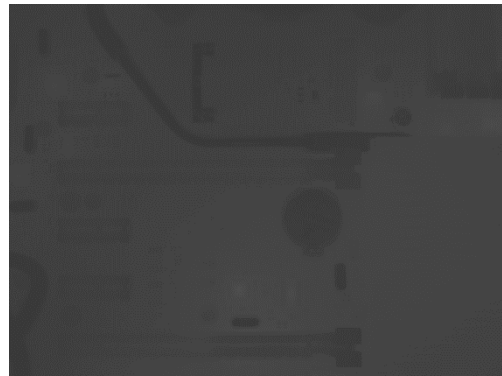

Bit Range = 5-12



Bit Range = 6-13



---

## Controlling A68/A38 Using the Sopera LT API

In addition to CamExpert, Sopera LT SDK provide full API to configure A68/A38 parameters and acquire images. It includes sample demo applications and programming examples with source code. By default they are installed under the directory:

**C:\Program Files\Teledyne DALSA\Sopera\Demos\**

Of particular interest is the *GigE Camera Demo* (available in pre-compiled form, with C++ and C# source projects). This project provides everything needed to acquire images from the camera. It can be easily modified to write required values to parameters (called 'features' in GenICam).

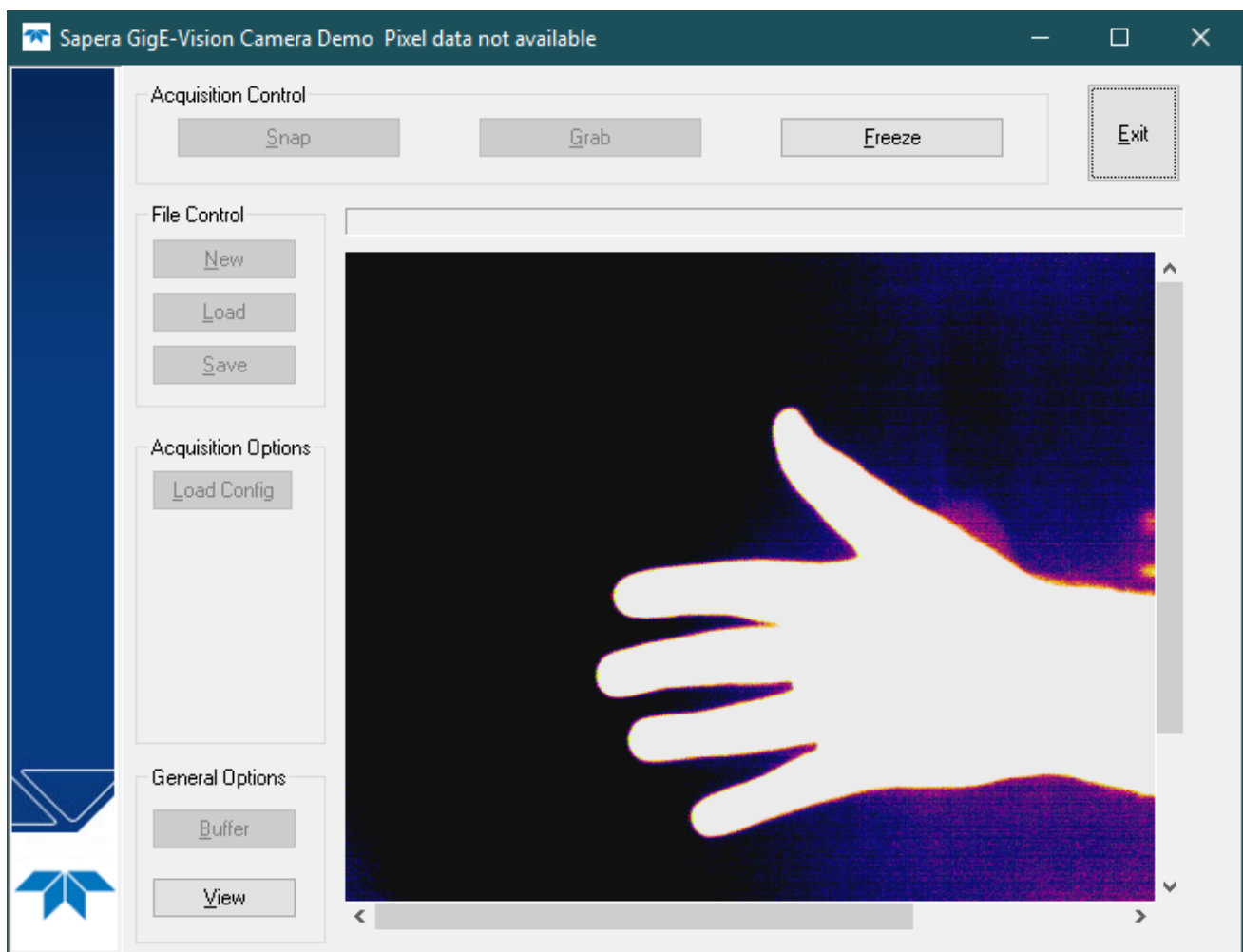

The *Camera Features* example demonstrates how to access the available features of the camera.

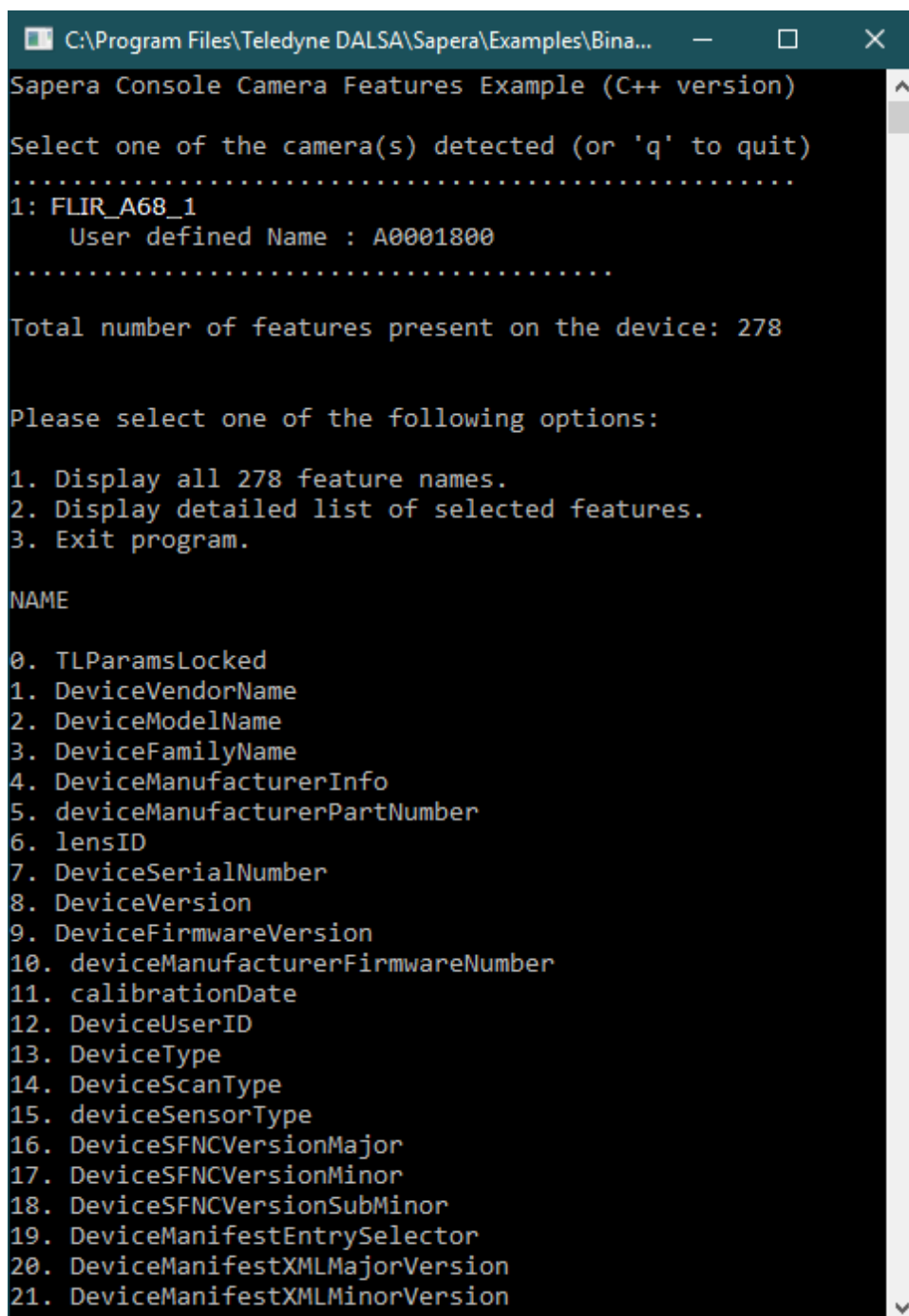

```
Sapera Console Camera Features Example (C++ version)
Select one of the camera(s) detected (or 'q' to quit)
.....
1: FLIR_A68_1
   User defined Name : A0001800
.....

Total number of features present on the device: 278

Please select one of the following options:

1. Display all 278 feature names.
2. Display detailed list of selected features.
3. Exit program.

NAME

0. TLPParamsLocked
1. DeviceVendorName
2. DeviceModelName
3. DeviceFamilyName
4. DeviceManufacturerInfo
5. deviceManufacturerPartNumber
6. lensID
7. DeviceSerialNumber
8. DeviceVersion
9. DeviceFirmwareVersion
10. deviceManufacturerFirmwareNumber
11. calibrationDate
12. DeviceUserID
13. DeviceType
14. DeviceScanType
15. deviceSensorType
16. DeviceSFNCVersionMajor
17. DeviceSFNCVersionMinor
18. DeviceSFNCVersionSubMinor
19. DeviceManifestEntrySelector
20. DeviceManifestXMLMajorVersion
21. DeviceManifestXMLMinorVersion
```

# Features and Configuration Options

The following sections describe features and configuration options. These include:

- Heat Sinks
- Adjusting the Lens Focus
- LED Indicators
- Fixed Pattern Noise Correction
- Radiometry
- False Color Mapping
- Metadata
- Pixel Polarity
- Defective Pixel Correction
- Median Filter
- Contrast Enhancement
- Camera Synchronization
- External Trigger
- Sensor Readout Alignment Mode
- Precision Time Protocol
- Internal Test Pattern Generator
- Temperature Sensors
- Error Log File

---

## Heat Sinks

FLIR A68/A38 series cameras are designed to optimally transfer internal component heat to the outer metallic body. If the camera is free standing (that is, not mounted) it will be warm to the touch.

Basic heat management is achieved by mounting the camera onto a metal structure via its mounting screw holes.

Teledyne FLIR recommends that the FLIR A68/A38 series camera be mounted using heat sinks to optimize shutterless operation. Refer to the Mechanical Specifications section for information on the exact size and position of the camera mounting holes.

For radiometric operation (where the camera is expected to measure the temperature of objects in the scene), additional care should be taken to provide a stable operating temperature; please refer to the section [Mounting and Thermal Considerations](#).

---

## Adjusting the Lens Focus

The FLIR A68/A38 series cameras lenses are shipped with a factory calibrated setting nominally focused to infinity. If necessary, the user can adjust the lens manually to achieve the required focus. When the required focus is achieved, the lens position can be secured by tightening the lens lockdown screws (with a 1.5mm hex driver).

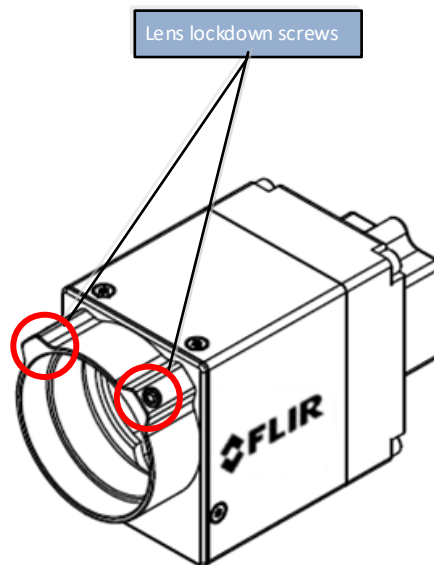

Figure 3: Lens Lockdown Screws



**Note:** To avoid overtightening the lens screws use a nominal torque of 1.5 in-lbs.





## LED Indicators

The FLIR A68/A38 series has one multicolor LED to provide a simple visible indication of camera state conditions.

### FLIR A68/A38 Series LED States

After the A68/A38 connects to a network and an IP address is assigned, the Status LED will turn to steady blue. Only at this time will it be possible by the GigE Server or any application to communicate with the camera. The following table summarizes the LED states and corresponding camera status.

Table 8: FLIR A68/A38 Series LED States

OFF	No power to the camera.
	Initial state on power up before flashing. Remains as steady Red only if there is a fatal error. Camera is not initialized.
	Initialization sequence in progress.
	IP address assigned.
	Application connected.



**Note:** Even if the FLIR A68/A38 series camera has obtained an IP address, it might be on a different subnet than the NIC it is attached to. Therefore, if the A68/A38 LED is blue but an application cannot see it, this indicates a network configuration problem. Review troubleshooting suggestions in the Network Imaging manual.

### FLIR A68/A38 Series LED States on Power Up

The following LED sequence occurs when the A68/A38 camera is powered up and connected to a network.

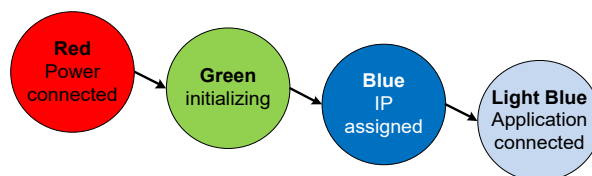

Figure 4: FLIR A68/A38 Series LED Startup Sequence

---

## Fixed Pattern Noise Correction

FLIR A68/A38 series cameras are factory calibrated to correct for fixed pattern noise. The camera dynamically corrects the sensor response across the entire range of the camera's ambient operating temperature using the factory calibration.

If the thermomechanical conditions of the camera differ significantly from the factory calibration conditions, non-uniformities or unwanted artifacts may be seen in the sensor response (for example, a halo or vignetting effect). This may be caused by the environmental conditions or the particular camera installation (for example, how the camera is mounted, the type of heat sinks, or airflows present, and so forth).

When using triggers in frame-on-demand mode, if the triggered acquisition is from a cold start, the first few images might be of lower quality as the sensor heats up. In addition, if external triggers are used to acquire images, the trigger frequency must be stable enough so the sensor can maintain a constant temperature (when the camera is in free running mode the camera temperature is constant).

However, if required, any remaining (or newly introduced) fixed pattern noise (FPN) can be corrected by the user. FPN correction is performed exposing the camera on a **scene of uniform temperature** and triggering the FPN calibration feature ([flatfieldCalibrationFPN](#)).

The FLIR A68/A38 series allows users to perform a manual fixed pattern noise (FPN) correction by providing the camera sensor a uniform scene using either:

- The camera's internal mechanical shutter
- User-defined external shutter



**Note:** FPN correction using the camera's internal mechanical shutter does not compensate for some lens effects. For FPN correction to account for lens effects, a manual correction must be performed by placing a suitable external shutter target in front of the lens; refer to [Performing Manual FPN Correction With External Shutter](#) for more information.

### Target Mode

The FPN Target Mode ([shutterTarget](#)) feature specifies if the shutter is external or internal.

## Saving Fixed Pattern Noise Calibration

After calibration, the FPN calibration coefficients can be saved to non-volatile camera memory. When enabled, the FPN correction is applied in addition to the default factory calibrated non-uniformity correction.

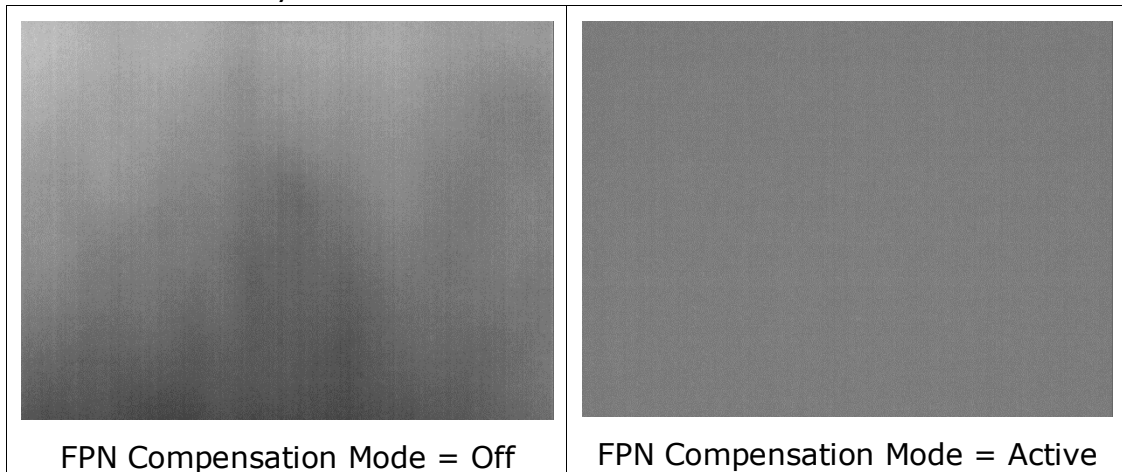

Figure 5: FPN Compensation Mode



**Note:** FPN correction is only valid at the operating temperature at which it was calculated; the further the camera operating temperature is from the correction point, the less accurate the correction.

## Performing Manual FPN Correction with Internal Shutter

1. Set the FPN Target Mode feature to [Internal Shutter \(Advanced\)](#), available in the FPN Correction category:

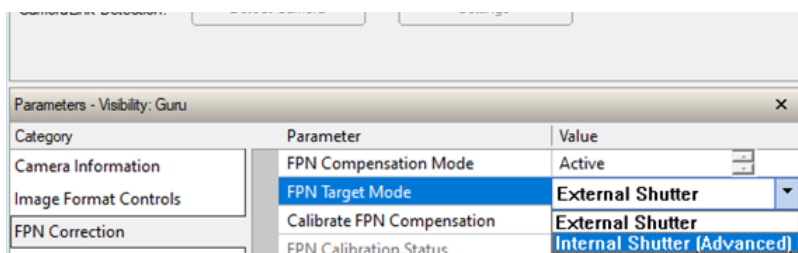

2. With the camera at nominal operating temperature, execute the calibration using the Calibrate FPN Compensation feature:

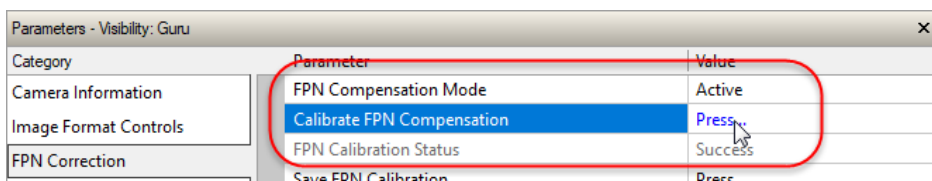

3. If the FPN results are satisfactory, coefficients can be saved to non-volatile device memory using the Save FPN Calibration ([flatfieldCalibrationSave](#)) feature:

FPN Compensation Mode	Active
Calibrate FPN Compensation	Press...
Save FPN Calibration	Press...
Lens Correction	None

For information on troubleshooting the internal mechanical shutter, refer to the Internal Shutter Problems section.

## Performing Manual FPN Correction with External Shutter

4. With the camera at nominal operating temperature, expose the camera (with the lens) to a scene of uniform temperature. For example, this can be done using an object with a flat surface, ideally matte black and non-reflective, such as a metal plate. This flat surface must not be in direct contact with the camera lens to avoid heat transfer or reflection; leave a small gap between the surface and the lens so they do not touch.

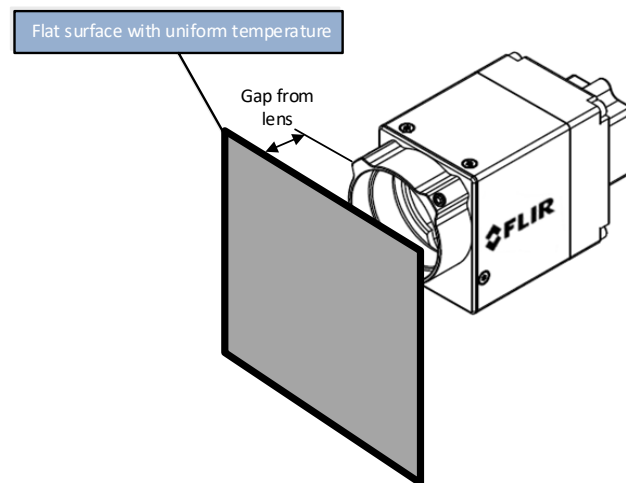

Figure 6: Performing FPN Correction



**Note:** When using an external shutter, if a scene of uniform temperature is not used for FPN correction, resulting images will have artifacts.

The following images demonstrate the effect of a faulty FPN correction due to the use of a non-uniform scene.



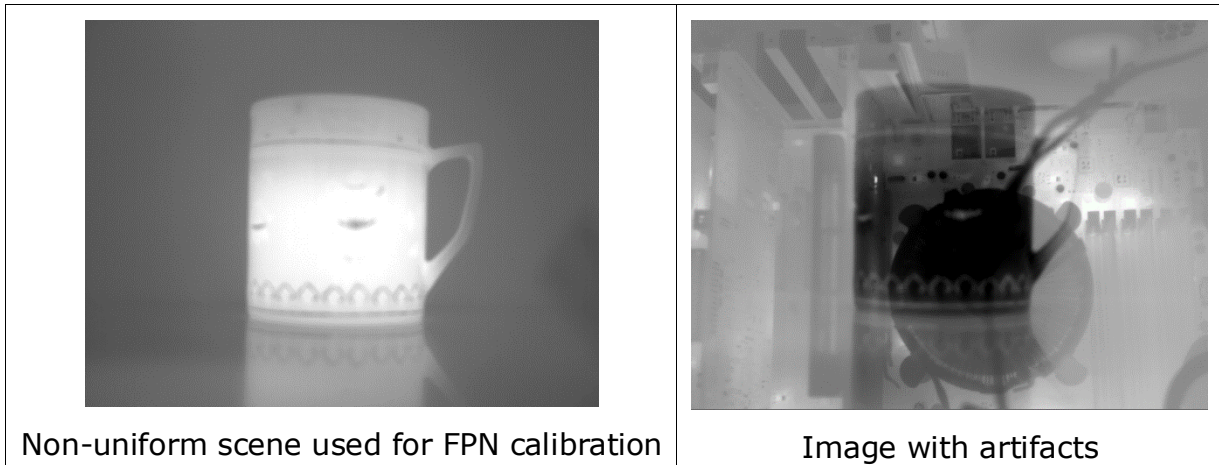
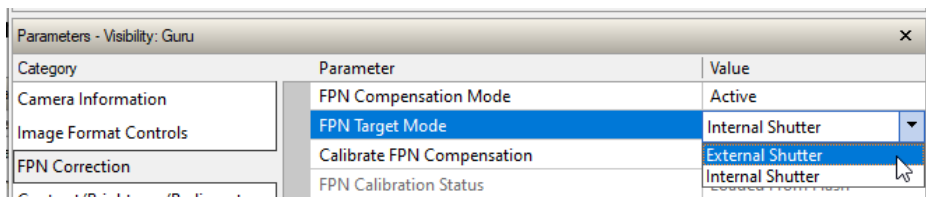
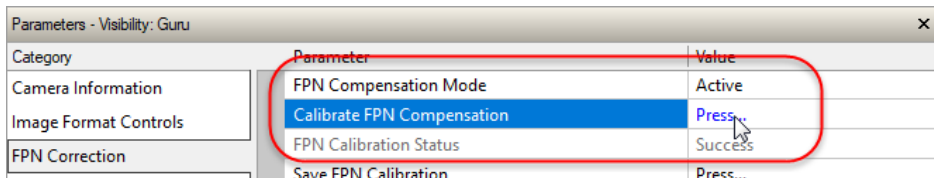

Figure 7: Faulty FPN Calibration

- Set the FPN Target Mode feature to External Shutter, available in the FPN Correction category:



- Execute the calibration using the Calibrate FPN Compensation ([flatfieldCalibrationFPN](#)) feature:



- If the FPN results are satisfactory, coefficients can be saved to non-volatile device memory using the Save FPN Calibration feature:

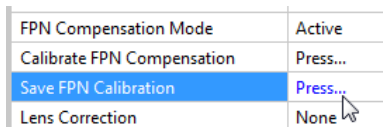

## FPN Correction Using Triggered Acquisition

FPN correction provides the best image quality if FPN calibration is performed under normal operating conditions. This depends on how the sensor is triggered:

- If [TriggerMode](#) is set to Off or the Exposure Alignment Mode ([readoutAlignment](#)) is set to *FreeRunning*, then the camera is constantly acquiring images from the sensor. In this configuration no special care is required for FPN calibration.
- If [TriggerMode](#) is On and [readoutAlignment](#) is set to *FrameOnDemand*, triggers should be provided to the camera at the same rate they will be provided in normal camera operation. If no triggers are provided, the FPN calibration will fail and [flatfieldCalibrationStatus](#) will return Timeout.

## Automatic FPN Calibration

The camera can optionally be configured to automatically recalibrate the FPN correction, depending on the value of [autoShutterMode](#):

- *Off*: the camera will never trigger an FPN calibration on its own;
- *Temperature*: the camera will trigger an FPN recalibration if its internal temperature drifts more than [autoShutterMaxTempDiff](#) Celsius since the last FPN calibration;
- *Time*: the camera will trigger an FPN recalibration if more than [autoShutterMaxDelay](#) seconds have elapsed since the last FPN calibration;
- *TimeTemperature*: FPN recalibration will be triggered if either the temperature or time criteria is exceeded.

The [autoShutterMinDelay](#) feature allows setting a minimum time between automatic FPN calibrations.

## Performing Calibration of the Supplemental FPN Correction Table

When performing an FPN calibration with the internal shutter, some non-uniformities can remain in the image. These are due to the distribution of heat in camera components, such as the camera casing and lens, that are 'hidden' by the internal shutter when it is closed. This distribution of heat is dependent upon the specific operating conditions: camera mounting, air flow, etc.

The camera attempts to correct these non-uniformities through a supplemental FPN table. This static table is factory-calibrated to provide a reasonably good correction in a variety of operating temperatures; for optimal image quality in a specific environment, this table can be recalibrated:

- First, make sure that the camera sees a flat surface with uniform temperature, such as for an FPN calibration with an external shutter.
- Start image acquisition in the camera; ideally the camera should acquire images for a certain period of time (for example, 10 minutes) to reach a stable operating temperature.
- Write to the feature [supplementalFPNCalibrate](#). This will trigger the calibration; ensure that the flat surface stays in front of the camera for the duration of the calibration.
- You can then set [shutterTarget](#) to *InternalAdvanced* and perform an FPN calibration with the internal shutter by writing to the feature [flatfieldCalibrationFPN](#).

If the image quality is good, save the newly calibrated supplemental FPN table by writing to the feature [supplementalFPNSave](#).

## Related GigE Vision Features

Feature related to control the FPN correction and are part of the FPN Correction Category.

# Radiometry

The A68/A38 series cameras support radiometric temperature measurements as a stand-alone GigE camera or as an integrated OEM part of another system. In both cases, certain integration considerations are essential to obtain the highest camera accuracy and performance. This section highlights the most important aspects of such an integration.

## Converting Pixel Values to Temperatures



**Note:** Temperature readings assume that objects have a surface emissivity coefficient of 0.99; temperature readings of objects with different emissivity coefficients must be adjusted accordingly.

### Conversion From a 16-bit Image

One way to calculate temperature values in Celsius is to configure the camera to output 16-bit values. To do so, set the Pixel Format ([PixelFormat](#)) feature, available in CamExpert in the Image Format Controls Category, to Monochrome 16-Bit (Mono16).

Category	Parameter	Value
Camera Information	Sensor Width	640
	Sensor Height	480
	Width	640
	Height	480
	Pixel Format	Monochrome 8-Bit
	Color Map	Monochrome 8-Bit
	Pixel Polarity	Monochrome 16-Bit
	Test Pattern	YUVV
	Test Pattern Constant Value	Off
		Not Enabled

The equations to calculate temperature or DN are:

$$T = \frac{DN - radiometryOffset}{radiometryGain}$$

$$DN = (T * radiometryGain) + radiometryOffset$$

Where:

- T = degrees Celsius (°C).
- DN = pixel value (in 16-bits image)
- [radiometryOffset](#) is the feature that sets the pixel value when the scene is at 0 degrees Celsius. By default, it is factory-initialized to 30000 but this value can be changed.
- [radiometryGain](#) is the feature that sets the responsivity of the camera (that is, the slope of the curve), in DN per degrees Celsius. By default, it is factory-initialized to 100 DN per Celsius but this value can be changed.

For example, if a pixel has a value of 33851 and [radiometryOffset](#) and [radiometryGain](#) have their default values, the corresponding temperature is:

$$33851 = (T * 100) + 30000 \rightarrow (33851 - 30000)/100 = 38.51^{\circ}\text{C}$$

## Conversion From an 8-Bit Image

Conversion from a monochrome 8-bit image to a temperature is more indirect. Since the camera maps the sensor's 16-bit output to an 8-bit image for display, the relationship between pixel value and temperature depends upon the contrast mode (see feature [contrastMode](#)):

- For *Static* (fixed range in DN value) and *StaticTemperature* (fixed temperature range) modes, the camera maps the sensor's pixel value [contrastMinValue](#) to 0 in the 8-bit image and the pixel value [contrastMaxValue](#) to 255. Temperatures in between are mapped linearly; the equations to obtain the temperature become:

$$T_{min} = \frac{\text{contrastMinValue} - \text{radiometryOffset}}{\text{radiometryGain}}$$

$$T_{max} = \frac{\text{contrastMaxValue} - \text{radiometryOffset}}{\text{radiometryGain}}$$

$$T = T_{min} + (T_{max} - T_{min}) * \frac{(DN - \text{contrastMinValue})}{(\text{contrastMaxValue} - \text{contrastMinValue})}$$

- For *AdaptiveDynamic* and *AdaptiveFixed* modes, the camera constantly adjusts how the sensor's 16-bit images are mapped to 8-bit images that can be displayed. The boundary 16-bit pixel values are provided for every frame, in the [frame's metadata](#), in the fields *contrastZoneMin* and *contrastZoneMax*. The equations become:

$$T_{min} = \frac{\text{contrastZoneMin} - \text{radiometryOffset}}{\text{radiometryGain}}$$

$$T_{max} = \frac{\text{contrastZoneMax} - \text{radiometryOffset}}{\text{radiometryGain}}$$

$$T = T_{min} + (T_{max} - T_{min}) * \frac{(DN - \text{contrastMinValue})}{(\text{contrastMaxValue} - \text{contrastMinValue})}$$

For all contrast modes, a convenient way to visualize temperature values is to enable the color map overlay (see [Overlays](#) section). This overlay is also available when the camera is configured to output color images (with YUYV pixel format).

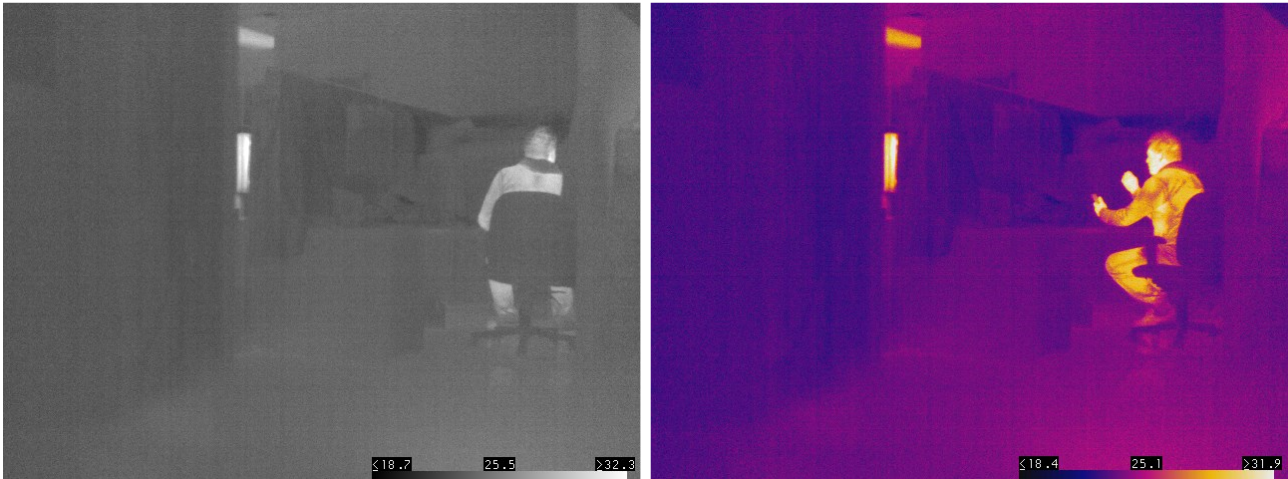

Figure 8: Color Map Overlay

### Mounting and Thermal Considerations

Adequate heatsinking must be provided to prevent the camera from overheating, particularly when operated in temperatures approaching the upper temperature range of the device. The FPGA inside the camera must always be maintained at a temperature at or below 85°C.

Teledyne DALSA recommends connecting the camera to the system by the bottom mounting holes of the camera, preferably having some metallic part connected thermally to the chassis of the system fully pressed against the whole surface of the camera bottom. This will not only prevent overheating, but also allow the camera to stabilize to varying conditions around the system.

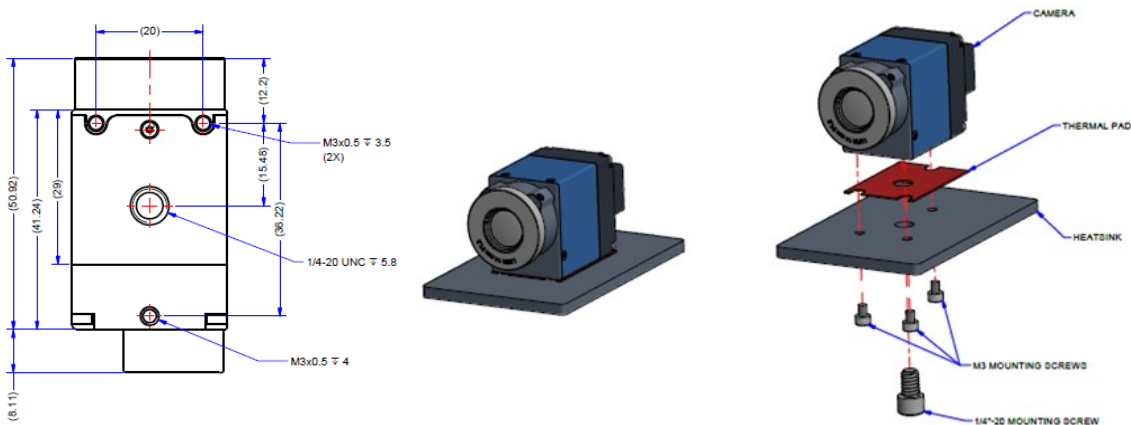

Figure 9: Mechanical camera interface (left) used for thermal coupling during mounting on heatsink (right)

Additional thermal connections on the other camera sides further improve internal camera temperature stabilization.

To the extent possible, the camera, while thermally connected to the system/environment, should be insulated from rapid temperature swings and changes in airflow. Extreme thermal shock reduces the effectiveness of calibration and degrades the quality of the image and the accuracy of the reading. For example, if the camera is only mounted on a tripod the ambient temperature change will influence the complete camera thermal behavior leading to a less accurate temperature reading.



Figure 10: Camera Mounted on Tripod

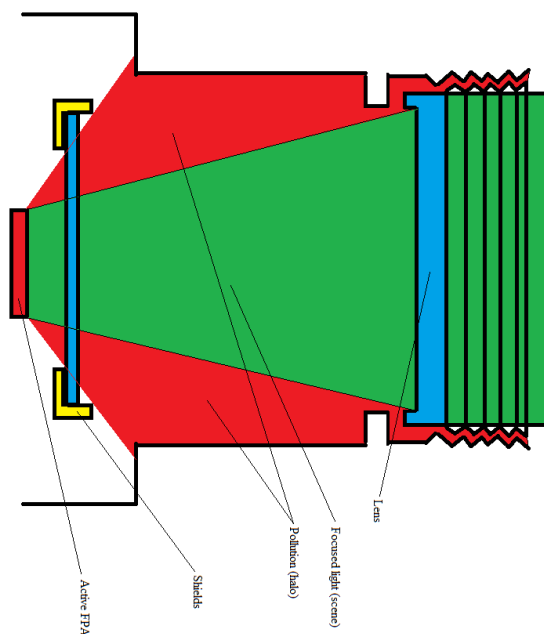



Figure 11: Camera Schematic Showing Flux Contribution: Red = internal housing contribution, Green = useful IR flux part coming from the scene through the lens

Signal coming from the red part (camera internal housing) in the above schematic represents pollution that must be subtracted from the image for proper temperature measurements. This process is (generally) handled by the camera's shutterless Non-Uniformity Correction (NUC) mechanism.

However, NUC correction considers the deltas between the camera’s different component’s temperatures (lens/shutter/mechanics/sensor). Significant changes to the thermal connection of the camera to the environment or in airflow around the camera will affect the signal coming from these parts and can require an adjustment of the reference level of measurements. This is not pronounced for imaging applications, but when very accurate temperature measurement is needed this contribution should be considered.



**Note:** The term “Correction” (such as in Non-Uniformity Correction) is related to the pixel-to-pixel correction necessary for good image quality. This correction manages the pixel-to-pixel differences by applying a gain and offset to each pixel, resulting in a uniform image of a uniform scene over an operating temperature range minimizing spatial noise.

“Calibration” is related to the conversion between the sensor output (DN) and the scene temperature. There is no direct relation between the pixel-to-pixel correction and the temperature calibration.

In such conditions, the camera is quite sensitive to ambient temperature change as shown in Figure 4.

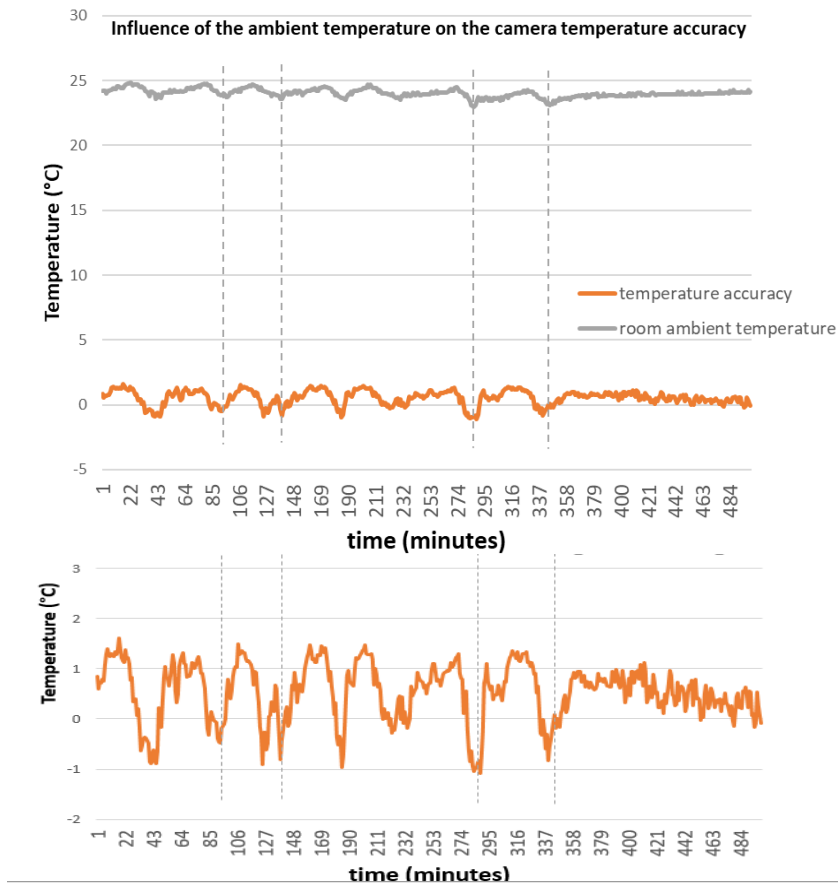

Figure 12: Influence of Airflow on Temperature Accuracy

For best results, the camera should be isolated from the thermal effects of window heaters, variable fans and other intermittent thermal drifts (for example, air conditioning, windows, doors). Due to these external environmental fluctuations,



thermal cameras are generally mounted inside a box (enclosure) with an IR transparent window.

## Using Enclosures

Avoid mounting conditions and enclosures which expose the camera to asymmetric heating from systems and other heat sources. If air cooling is present in the system, airflow should be directed away from the camera/lens/window and as much as possible be constant and symmetric around the optical line of sight. Also, the presence of these external heat sources or fans will cause the camera to require an offset (reference level) to the measurements.



Figure 13: Camera in Enclosure Configuration (with and w/o window)

The enclosure acts as a thermal stabilizer such that external airflow/ambient temperature change do not directly reach the camera and slows down temperature evolution around the camera. The result is a stable camera environment resulting in better temperature accuracy.

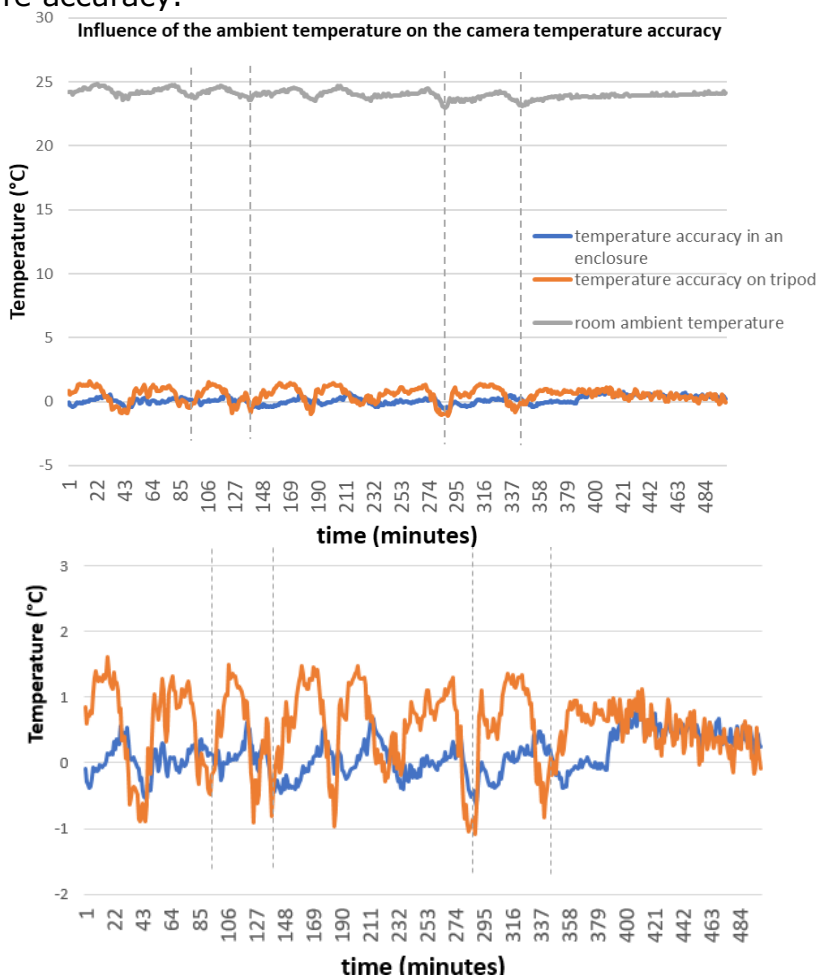

Figure 14: Temperature Accuracy Improvement Using an Enclosure

If a window is added in front of the lens as part of the design (window enclosure for example), both slope/gain and offset need to be readjusted to compensate for transmission loss. If the window material does not have sufficiently high transmission, window temperature and transmittance need to be considered in the correction values applied. The lower the window transmission the higher the impact on temperature accuracy, also factoring in the window temperature.

## Radiometric Calibration

The A68/A38 camera allows the user to compensate for mounting and enclosure elements by updating both gain and offset coefficients.



Before performing radiometric calibration, the camera should be at normal operating temperature; acquire images from the camera for a minimum of 30 minutes to allow the internal temperature to stabilize. A longer delay may be required when using the camera in an enclosure.

To compute the necessary gain and offset to apply, a high-quality heat source that emits radiation at a specific temperature, known as a blackbody, is necessary.

For gain calculation, at least two different temperature values between 35 and 45 °C are required for gain calibration. To simplify the procedure, two or more blackbodies are preferred; if only one blackbody is available, at least two different temperature settings must be used. The blackbodies should be placed at about 1.5m or more from the camera, centered in the frame as much as possible and correctly focused. For proper measurements, a blackbody should occupy a region of interest (ROI) of at least 20x20 pixels in the image.

For radiometric calibration, the procedure depends on whether a blackbody reference is available in the final deployment environment.

- **Blackbody not available:** a one-time calibration of the gain and offset values is performed using blackbody reference(s) in conditions that are as close to the deployment environment as possible.
- **Blackbody available:** automatic offset correction can be performed dynamically, providing more accurate results (gain calibration can be performed manually as required, after the initial calibration).



**Note:** An external reference temperature source in the camera Field Of view (FOV) is required by IEC 80601-2-59 (or FDA guidelines). This allows stable temperature information to compensate for the temperature reading if airflow is coming on the camera.

In addition to this external reference, IEC 80601-2-59/ISO-TR 13154 also requires installation of the camera far away from any external high temperature source or movement of air.

### Initial Feature Settings

For radiometric calibration, set the following feature values:

In the [Image Format Controls category](#), set the "Pixel Format" ([PixelFormat](#)) to "Monochrome 16-Bit".

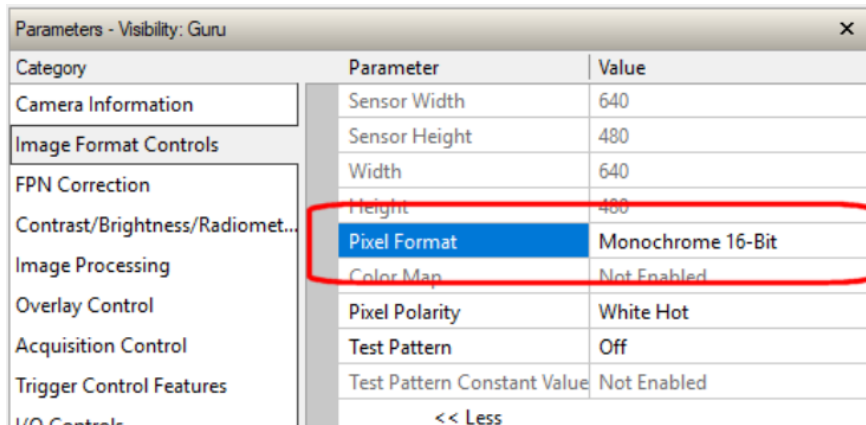

In the [Image Processing category](#):

- Set "Noise Filter Mode" ([noiseFilterMode](#)) to "Medium"
- Set "Median Filter Mode" ([medianFilterMode](#)) to "Selective"
- Set "Defective Pixel Replacement" ([defectivePixelReplacementMode](#)) to "Active".

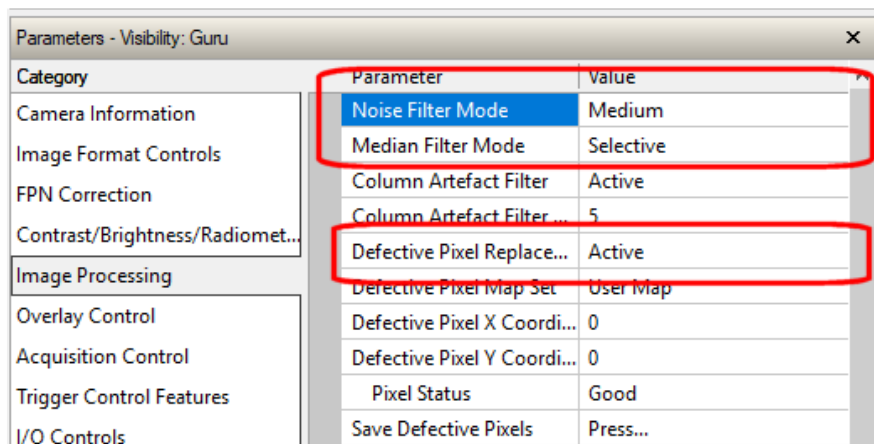

In the [FPN Correction category](#):

- Set the "FPN Compensation Mode" ([flatfieldCorrectionMode](#)) to "Active"
- Set the "FPN Target Mode" ([shutterTarget](#)) to "Internal Shutter (Advanced)"

Start a live acquisition (in CamExpert, click Grab), then press "Calibrate FPN Compensation" ([flatfieldCalibrationFPN](#)). A clicking sound should be heard from the camera, which indicates that its internal shutter has been activated. This allows the camera to eliminate any remaining non-uniformity from the images. Once the operation is complete, click Freeze.

## Calculating the Gain

Acquire a first image and measure the mean output of the ROIs corresponding to the active area of the blackbodies. The goal is to have multiple data points to establish the relationship between pixel values (in DN) and the related scene temperature (in °C)

If you are using at least two blackbody radiators, the image displayed in CamExpert contains all the data required for gain calibration. This image can be saved for analysis in an external program (such as ImageJ) to calculate the mean value of the ROI; right-click on the image and click "Save Image..." to save a .tif image.

Alternatively, the image can be analyzed directly in CamExpert:

- Double-click on the image being displayed; this creates a rectangle region where CamExpert will measure statistics.
- Move this region over a blackbody radiator using the mouse (drag-and-drop on the center of the region).
- Drag-and-drop the position of the corners of the region to make sure that it stays within the blackbody's surface. Ideally, it is preferable to measure a blackbody's pixel values over a region of at least 20x20 pixels, to average out small variations.
- Click on CamExpert's histogram icon, to open the Statistics window which contains the region's average value (note the value calculated).
- Repeat this sequence for every blackbody in the image.

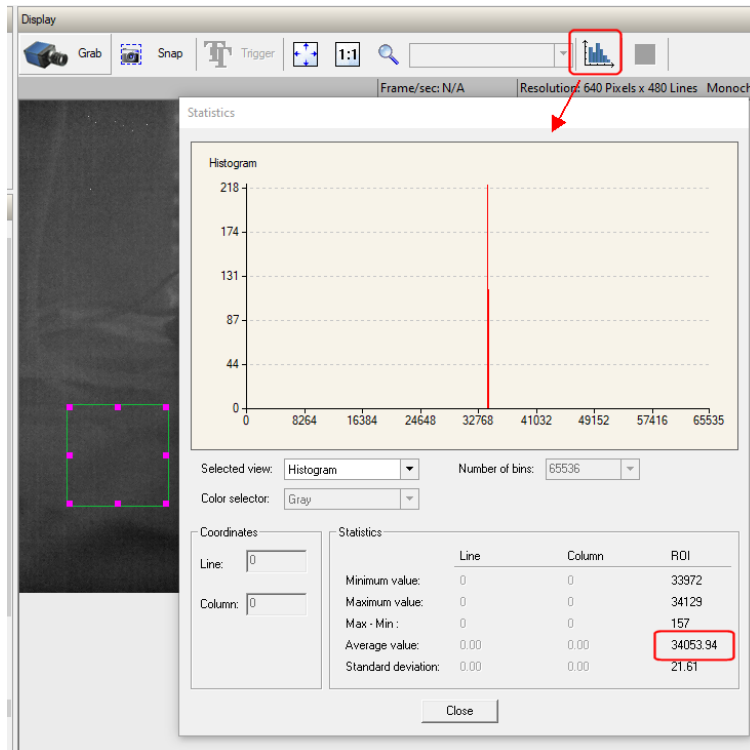

If using a single blackbody radiator, measure its average pixel value using the above procedure, then set the blackbody to a different temperature. When the blackbody is stable at its target temperature measure its average pixel value again.

## Data Analysis: Gain Correction

Perform a linear regression on these mean DN values to find the slope [DN/°C]. The line of best fit is described by the equation  $Y \text{ (DN)} = bX \text{ (Temperature)} + a$ , where  $b$  is the slope of the line and  $a$  is the intercept (that is, the value of  $Y$  when  $X = 0$ ). The gain to apply is simply 100 over the computed slope ( $100/b$ ). This provides a nominal response of 100 DN per °C.

For example, if using 4 blackbodies with the following Temperature, DN (X,Y) values:

X (Blackbody Temperature °C)	Y (DN)
35	33224
37	33361
40	33629
45	34005

The calculation summary is:

Sum of X= 157

Sum of Y= 134219

Mean X= 39.25

Mean Y= 33554.75

Sum of squares ( $SS_x$ ) = 56.75

Sum of products ( $SP$ ) = 4486.25

Regression Equation =  $\hat{y} = bX + a$

$b = SP/SS_x = 4486.25/56.75 = 79.05286$

$a = M_y - bM_x = 33554.75 - (79.05 \times 39.25) = 30451.92511$

$\hat{y} = 79.05286X + 30451.92511$

Therefore, the gain to apply is  $100 / b = (100/79.05) = 1.265$ .

Enter this gain value in the camera *Radiometry Gain Correction* feature, available in the [Contrast / Brightness/ Radiometry category](#).

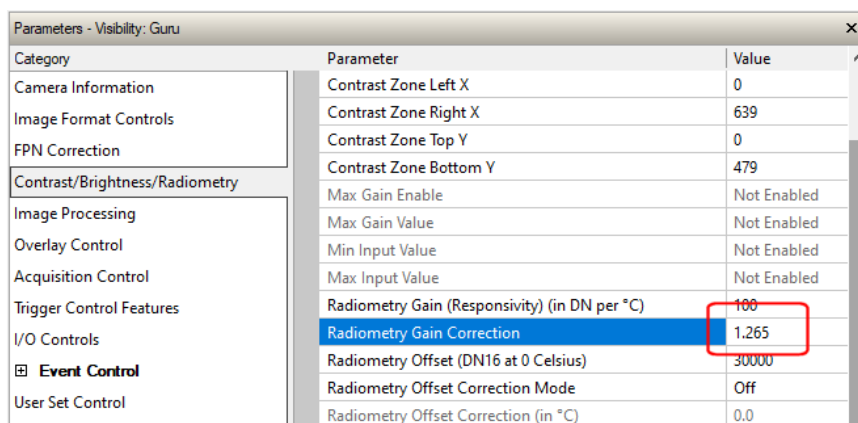

Figure 15: Gain feature for external optic adjustment.

## Calculating the Offset

After the gain correction has been entered into the camera, the offset correction can be calibrated. There are two methods to perform this:

- **Manual correction:** when the "Radiometry Offset Correction Mode" ([radiometryOffsetCorrectionMode](#), found under CamExpert's Contrast / Brightness / Radiometry category) is set to "Manual", the offset correction is static.
- **Automatic correction:** when the "Radiometry Offset Correction Mode" is set to "Reference = Zone1" or "Reference = Zone2", the camera assumes that a selected region in the image has a known temperature. Offset correction constantly adjusts to make sure that the camera reads the expected temperature in this region.

### Offset Correction: Manual Mode

- Make sure that there is a blackbody radiator in the scene, ideally with a temperature near the middle of the range for the scene temperatures (for example, 35 °C).
- Measure the average value for the blackbody's pixels.
- Convert this average pixel value to a temperature in °C, using the equation:

$$T = \frac{DN - radiometryOffset}{radiometryGain}$$

By default, [radiometryOffset](#) is factory-initialized to 30000 and [radiometryGain](#) is factory-initialized to 100.

Compare the camera's measurement with the actual temperature of the blackbody, to determine the required offset correction. Ideally, it is preferable to measure this offset correction over a range of blackbody temperatures and to compute the average correction.

For example:

<b>Blackbody Temperature</b>	35	37	40	45
<b>Camera-measured Temperature</b>	40.78284	42.51585	45.90599	50.6623
<b>Required Correction</b>	-5.782836	-5.515854	-5.905991	-5.662301
<b>Average Correction</b>	-5.716746			

This value can then be applied to the camera; set the Radiometry Offset Correction Mode to Manual, then set the value of "Radiometry Offset Correction" ([radiometryOffsetCorrection](#)) to the computed offset value (typically a negative value).

Parameter	Value
Contrast Mode	Fixed Adaptive
Contrast	200
Brightness	128
Contrast Zone Left X	0
Contrast Zone Right X	639
Contrast Zone Top Y	0
Contrast Zone Bottom Y	479
Max Gain Enable	Not Enabled
Max Gain Value	Not Enabled
Min Input Value	Not Enabled
Max Input Value	Not Enabled
Radiometry Gain (Responsivity) (in DN per °C)	100
Radiometry Gain Correction	1.0
<b>Radiometry Offset (DN16 at 0 Celsius)</b>	<b>-5.16746</b>
Radiometry Offset Correction Mode	Off
Reference Zone Temperature (in °C)	0.0
Radiometry Offset Correction (in °C)	0.0

Figure 16: Radiometric Offset Correction Feature

**Offset Correction: Automatic Mode**

Since most error sources manifest as a global temperature offset, having a known temperature source from a blackbody radiator as part of the scene provides a reference to dynamically correct any offset error caused by changing conditions around the camera during operation. This allows reaching a temperature accuracy close to that of the blackbody used as the reference.

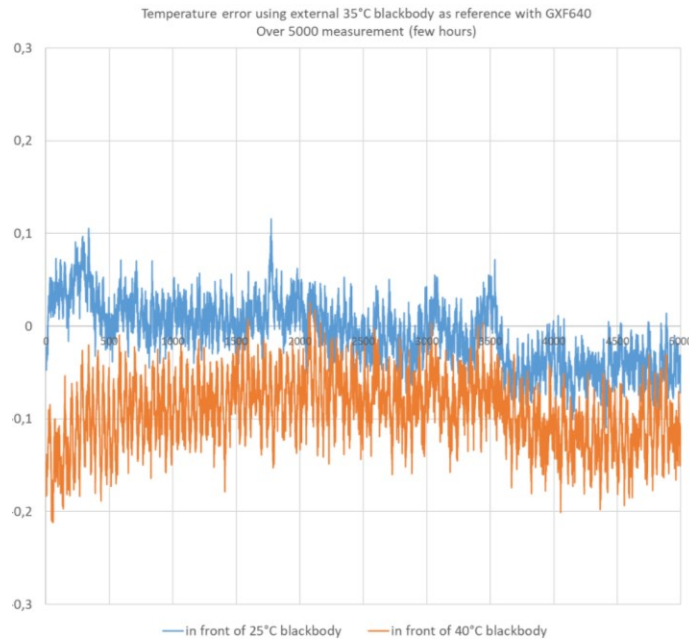

Figure 17: Temperature Accuracy (25°C & 40°C target objects) Using 35°C External Reference (IEC80601-2-59 requirements)

**To use an external blackbody reference:**

1. In CamExpert, enable the overlay control using the features available in the [Overlay Control category](#):
  - *Overlay Global Mode: Active*
  - *Overlay Selector: Zone 1*
  - *Overlay Mode: Active*

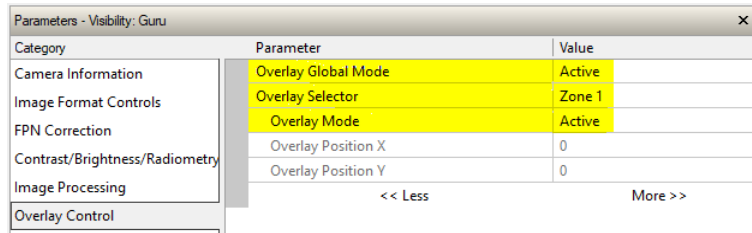

Figure 18: Overlay feature setup for external reference

2. Next, configure the camera to use the defined ROI (Zone 1) as the reference for the offset calculation using the features available in the [Contrast / Brightness/ Radiometry category](#) (feature values in green are to be determined by the user):
  - Radiometry Offset Correction Mode: Reference = Zone 1
  - Zone Selector: Zone 1
  - X1: ROI top left X coordinate
  - X2: ROI bottom right X coordinate
  - Y1: ROI top left Y coordinate
  - Y2: ROI bottom right Y coordinate
  - Reference Zone Temperature (in °C) = blackbody temperature

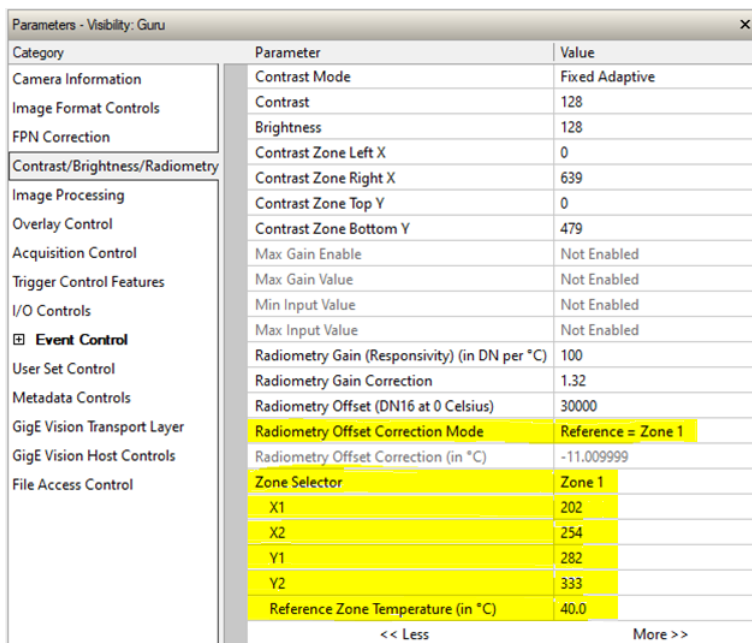

Figure 19: Radiometry features setup for external reference



---

# Overlays

The FLIR A68/A38 series camera can enable graphic overlays in the output image. Available overlays include: a reticle, colormap legend, frame counter, metadata, zone corners and alarm status. Each overlay can be individually enabled/disabled. Their positions are configurable. A global overlay mode parameter allows turning on or off all enabled overlays.

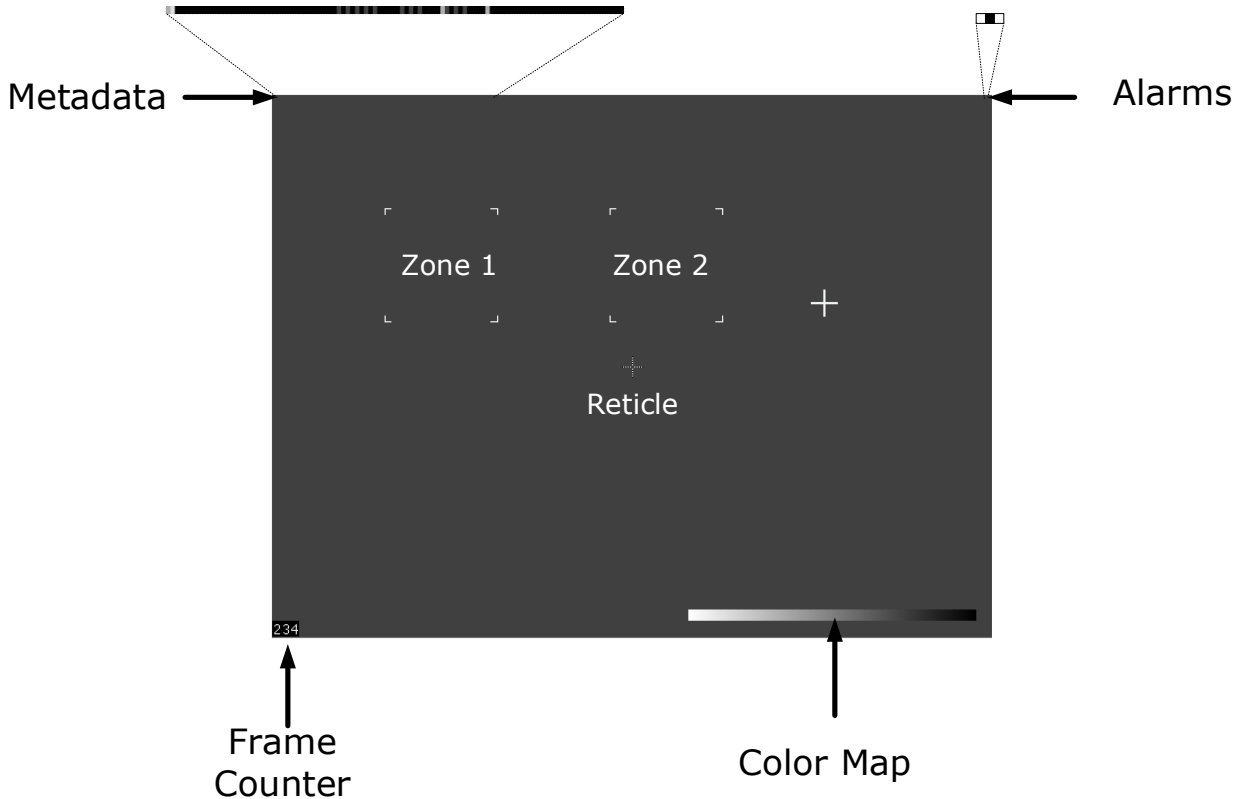
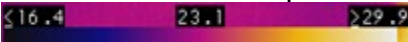
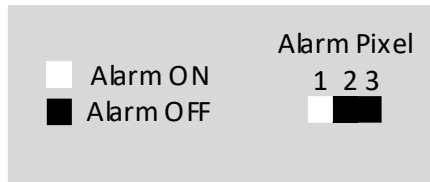

Figure 20: Overlays

- The reticle can be used to highlight specific regions.
  - The colormap legend indicates the relative intensity of the different colors or greyscale values.
    - Starting with firmware 2.50, the colormap for the FLIR A68/A38 series also prints the minimum, middle and maximum temperature values associated to each pixel intensity or color.
- 
- The frame counter increments with each frame acquired and is reset when the acquisition is stopped (therefore when snapping single frames the counter always reads 0).
  - Frame metadata is normally transferred separately from the pixels but it can be overlaid in the image itself for validation by tools that do not support GigE Vision's Extended Chunk Data payload. For more information refer to the Metadata section.
  - The Zone overlays highlight the corners of the Zones where the camera computes statistics; see features [zoneSelector](#), [zoneX1](#), [zoneX2](#), [zoneY1](#) and [zoneY2](#) in the [Contrast / Brightness / Radiometry Category](#).

- The status of the Alarms can be reported as pixel values in the image. The location of the overlay can be specified and consists of a consecutive segment of 3 pixels, each representing an alarm, with the pixel value 0 indicating Off and the highest pixel value for the image format indicating On (255 or 65545 for 8 and 16-bit; for YUYV the 8-bit Y component is used).



When triggered, an alarm remains in the On state until it is reset. Alarms are configured using the features available in the [Event Control](#) category.

## Related GigE Vision Features

The [overlayGlobalMode](#), [overlaySelector](#), [overlayMode](#), [overlayPositionX](#) and [overlayPositionY](#) features control the graphic overlays and are part of the Overlay Control Category.

---

## False Color Mapping

The camera supports the use of false color to enhance contrast or reduce eye fatigue. To use a false color mapping the pixel format must be set to YUYV. The following color maps are available:

- **Greyscale:** 8-bit monochrome
- **Fire:** darker purple/blue indicates colder, yellow hotter
- **IronBlack:** white-to-black ramp for low values, then color highlights (similar to the Fire color map) for higher values
- **Custom:** a user-defined mapping.



Figure 21: Fire Color Map

A user-defined custom color map can be uploaded using the [File Access Control](#) dialog; select the "Miscellaneous" file type and "False Color Map" as the file. The file (.bmp) must be a one line 256 column 24-bit per pixel bitmap. The X position (0-255) indicates the pixel value and corresponding RGB value. Example color map files are provided in the firmware distribution under the CustomColorMaps directory. The color map range, represented as a bar of increasing pixel values and the corresponding color, can be displayed as an overlay in the image (see the [Overlays](#) section).



Figure 22: Fire Color Map Range Overlay

## Related GigE Vision Features

When the [PixelFormat](#) feature enables a color map when set to YUYV; the [falseColorMap](#) feature selects the color map. These features are part of the Image Format Controls Category.

# Metadata

Along with each image, the A68/A38 camera can optionally output metadata associated to that image. Metadata is appended to the image data:

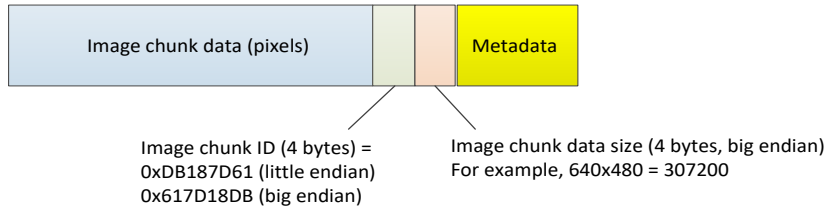

To accommodate the metadata information the image buffer height (allocated by the host application) must be increased by 2 lines (buffer height = image height +2). For example, if the image size is 640 x 480, the allocated buffer height is 482.

To append metadata to the image buffer the Metadata Active feature, available in the [Metadata Controls category](#), must be set to True (*ChunkModeActive* = True).

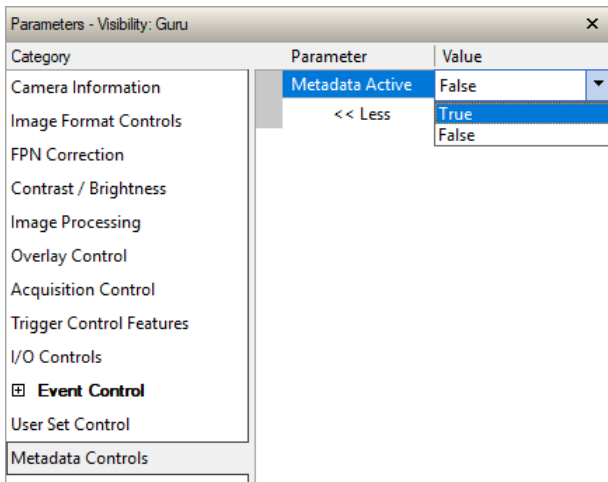

In addition, the Metadata Enable feature, available in the [GigE Vision Transport Layer category](#), must be set to True (*GevSCCFGExtendedChunkData* = True).

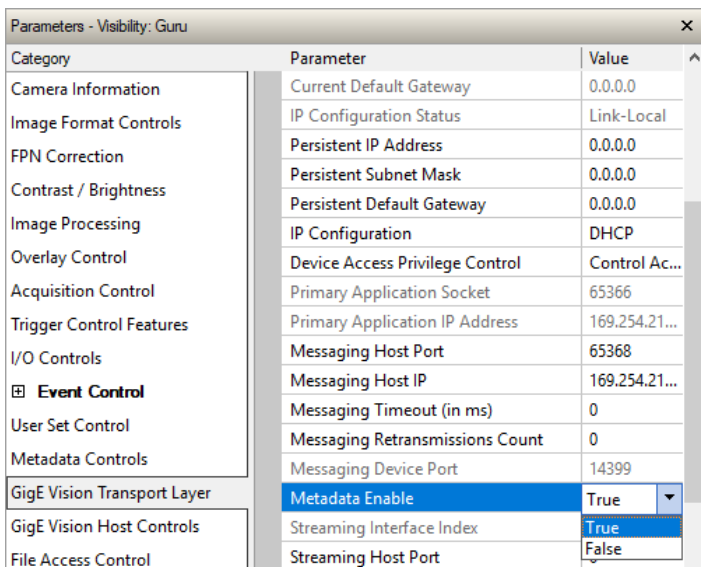

The metadata contains the following values, in this order:

Type	Value	Description
unsigned short	revision;	Version of the metadata structure.
unsigned short	size;	Total size of the metadata (including a number bytes reserved for future use).
unsigned char [16]	serialNumber;	String representing the serial number of the camera that generated the image.
unsigned char [8]	firmwareRevision;	String representing the firmware revision of the camera that generated the image.
float	cameraTemperature;	Temperature of the camera, in degrees Celsius.
float	sensorTemperature	Temperature of the IR sensor, in degrees Celsius.
unsigned int	frameInfo;	Unused
unsigned int	frameDropCount;	Number of frames that couldn't be output by the camera because of Ethernet issues (e.g. bandwidth).
unsigned int	frameId;	Frame number (reset to 0 when acquisition starts).
unsigned long long	frameTimestamp	Timestamp (in nanoseconds) of the start of the frame's acquisition, as identified by the camera's internal Timestamp clock.
unsigned int	trigInfo;	Invalid frame trigger count.
unsigned long long	trigTimestamp;	Timestamp of the trigger that resulted in the frame acquisition.
unsigned int	AlarmStatus;	Status of the alarm.
unsigned int [5]	Rsv1;	Reserved for future use.
unsigned int	line1Count;	Line 1 count.
char [32]	Rsv2;	Reserved for future use.
unsigned short	contrastZoneRangeMin;	Contrast zone range minimum.
unsigned short	contrastZoneRangeMax;	Contrast zone range maximum.
unsigned short	contrastZoneMin;	Contrast zone minimum.
unsigned short	contrastZoneMax;	Contrast zone range maximum.
unsigned short	contrastZoneAvg;	Contrast zone range average.
unsigned short	contrastZoneStddev;	Contrast zone range standard deviation.
unsigned short	contrastZoneGain;	Contrast zone gain.
unsigned short	zone1Min;	Minimum value of the zone 1.
unsigned short	zone1Max;	Maximum value of the zone 1.
unsigned short	zone1Avg;	Average value of the zone 1.
unsigned int	zone1ThreshCount;	Threshold value of the zone 1.
unsigned short	zone2Min;	Minimum value of the zone 2.
unsigned short	zone2Max;	Maximum value of the zone 2.
unsigned short	zone2Avg;	Average value of the zone 2.
unsigned int	zone2ThreshCount;	Threshold value of the zone 2.
unsigned short [640]	colAvg;	Each value gives the average pixel value of the corresponding column in the image.

Alternatively, this C definition can be used:

```
#include "cordef.h" // to get definitions of UINT16, UINT32 and so on

#pragma pack(push,1)
typedef struct
{
    unsigned short revision; // FW 2.42: rev=5, FW 2.43: rev=6    unsigned short size;
    unsigned char serialNumber[16];
    unsigned char firmwareRevision[8]; // unused
    float cameraTemp;
    float sensorTemp;
    unsigned int frameInfo; // unused
    unsigned int frameDropCount;
    unsigned int frameId;
    unsigned long long frameTimestamp;
    unsigned int trigInfo;
    unsigned long long trigTimestamp;
    unsigned int alarmStatus;
    unsigned int rsv1[5];
    unsigned int line1Count;
    char rsv2[32];
    unsigned short contrastZoneRangeMin;
    unsigned short contrastZoneRangeMax;
    unsigned short contrastZoneMin;
    unsigned short contrastZoneMax;
    unsigned short contrastZoneAvg;
    unsigned short contrastZoneStddev;
    unsigned short contrastZoneGain;
    unsigned short zone1Min;
    unsigned short zone1Max;
    unsigned short zone1Avg;
    unsigned int zone1ThreshCount;
    unsigned short zone2Min;
    unsigned short zone2Max;
    unsigned short zone2Avg;
    unsigned int zone2ThreshCount;
    unsigned short colAvg[640]; // added with rev 6 of the metadata (FW 2.43)
} Metadata;
#pragma pack(pop)
```

## Related GigE Vision Features

To enable metadata, the [ChunkModeActive](#) feature, in the [Metadata Controls category](#), must be set to On. In addition, the Metadata Enable ([GevSCCFGExtendedChunkData](#)) feature, in the [GigE Vision Transport Layer category](#), must be set to True, otherwise the [ChunkModeActive](#) feature is disabled.

---

## Pixel Polarity

The FLIR A68/A38 series cameras can select the polarity of pixels as required. This allows white pixels (255) to represent either hotter or colder elements in the scene.

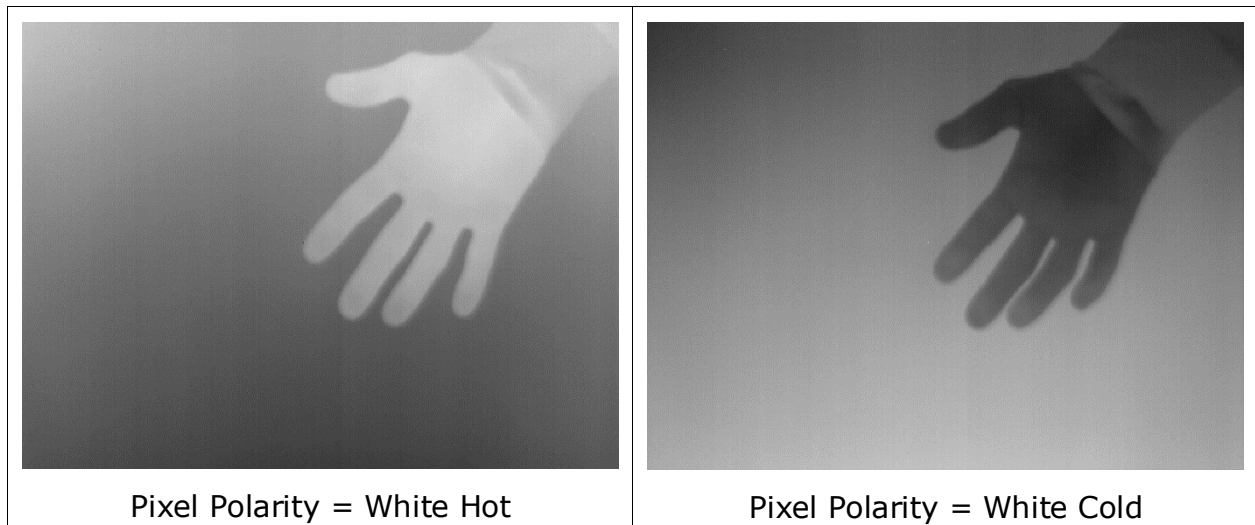

*Figure 23: Pixel Polarity*

### Related GigE Vision Features

The [pixelPolarity](#) feature is part of the Image Format Controls Category.

---

## Defective Pixel Correction

The FLIR A68/A38 series camera uses a defective pixel map to identify bad pixels in the sensor. These bad pixels are replaced by the average value of neighboring valid pixels. The defective pixel map is an 8-bit bitmap file (.bmp) that uses two pixel values; 0 (black) indicates a good pixel, non-zero values indicates a bad pixel.

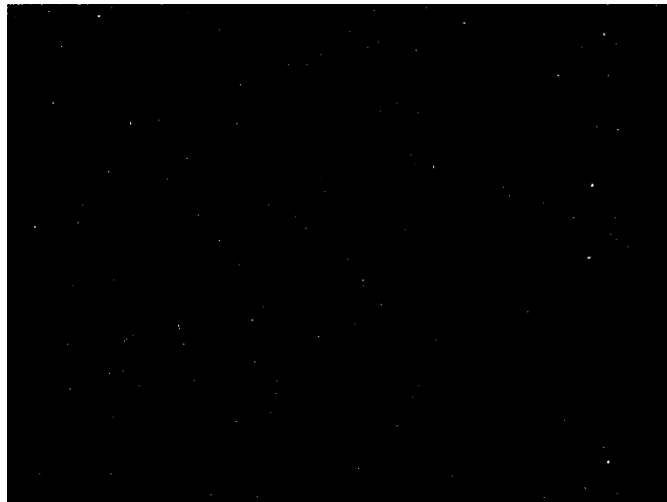

*Figure 24: Defective Pixel Map*

Two defective pixel maps are available: a factory calibrated set and a user-defined map. The factory calibrated defective pixel map identifies defective pixels across the full range of ambient operating temperatures. The user-defined map adds pixels to the list of defective pixels if additional pixels become defective during the camera's life after factory initialization.

The user-defined map can be updated manually or using automatic defective pixel detection. Automatic pixel detection updates the user-defined map by launching a sequence that compares each pixel value with the average value of its neighbors.

To generate valid results, a uniform scene should be presented to the camera; the internal mechanical shutter can be used, or alternatively a uniform scene can be presented in front of the lens (for example, a sheet of paper, or a cardboard box; additionally, it can help to adjust the lens completely out of focus).

Configurable parameters include the size of the neighborhood window and the threshold used to identify bad pixels (the number of standard deviations from the average value).

The Defective Pixel Detection Window Size ([\*defectivePixelDetectionWindowSize\*](#)) and Defective Pixel Threshold features ([\*defectivePixelDetectionResponseThreshold\*](#)) determines the algorithm behavior. In general, for very uniform images, a larger window size provides more statistics; for less uniform images, a smaller window is recommended (a smaller window also results in faster execution time). The threshold sets the number of standard deviations from the normal pixel response beyond which a pixel is considered defective.



Use the Detect Defective Pixels feature ([defectivePixelDetectionTrigger](#)) to perform defective pixel detection.

Detect Defective Pixels	Press...
Defective Pixel Detection Window Size	51
Defective Pixel Threshold	5.0



**Note:** Automatic defective pixel detection only adds pixels to the list of defective pixels, therefore it can be run at different ambient operating temperatures to identify pixels that do not respond well at certain temperatures only.

If invalid results are generated, the user-defined defective pixel map can always be reinitialized from the factory defective pixel map. To restore the factory defective pixel map, use the Defective Pixel Map Restore Factory feature ([defectivePixelRestoreFactoryMap](#)).

Defective Pixel Map Restore Factory	Press...
Detect Defective Pixels	Press...

Both the factory and user-defined pixel maps can be downloaded from or uploaded to the camera using the file access functionality.

## Related GigE Vision Features

Users can access the user defective pixel map to modify individual pixels in this map using the features available in the Image Processing Category. Alternatively, an 8-bit .bmp image representing the defective pixel map can be downloaded from or uploaded to the camera using the File Access Control Category features.

The File Access Control dialog in CamExpert provides file access to the User Defect Pixel Map through the Miscellaneous file type category.

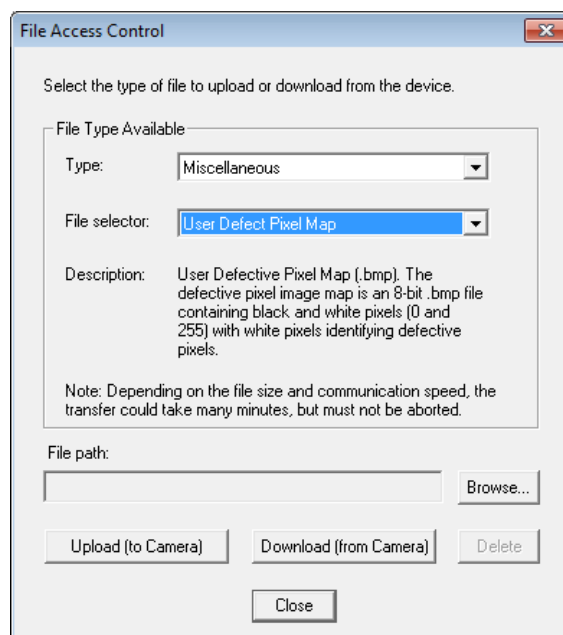

Figure 25: File Access Control

## Median Filter

The FLIR A68/A38 series camera can apply a median 3x3 filter to perform image smoothing. This filter is applied to the entire image and can be used to reduce image noise and other artifacts.

The following examples use a zoomed image to show the effects of the median filter at pixel level.

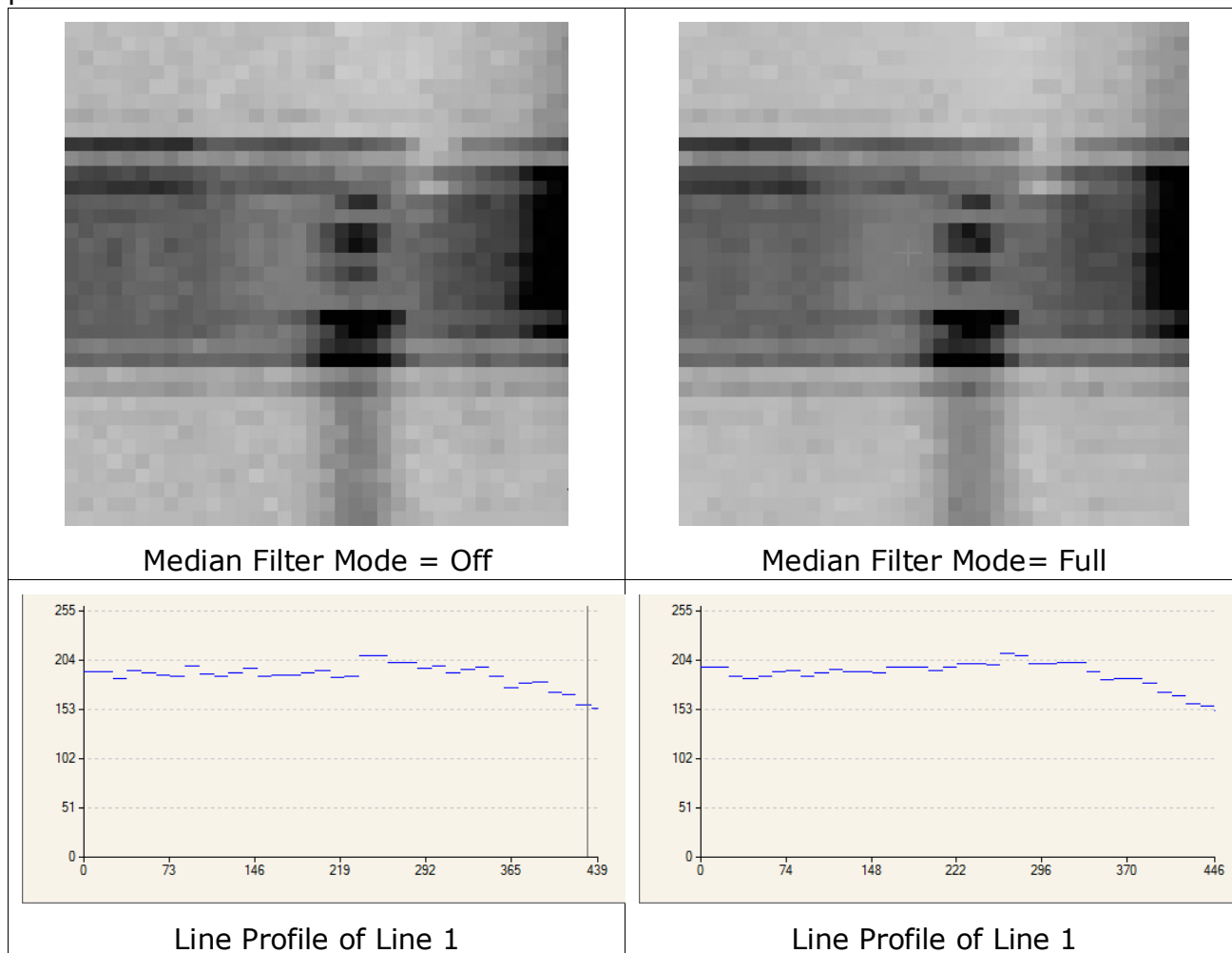

Figure 26: Median Filter

In addition, Median Filter Mode can be set to Selective, in which case the median filter is only applied to pixels which are significantly different from their neighbors. This configuration can be used to replace defective pixels.

## Related GigE Vision Features

The [medianFilterMode](#) feature is part of the Image Processing Category.

# Contrast Enhancement

The native output of the FLIR A68/A38 series sensor is 16-bits. The contrast enhancement mechanism is implemented when the pixel output is 8-bits. Contrast enhancement maps the 16-bit image to 8-bits to output high quality, well-contrasted images, regardless of the temperature differences found in the scene.



**Note:** For GigE Vision digital output, the camera output pixel format can be set to either 16 or 8-bits (monochrome or YUYV). 16-bit output is FPN corrected but does not use any contrast enhancement features.

## Contrast Mode

The Contrast Mode ([contrastMode](#) feature) determines how the contrast is performed. 4 contrast modes are available:

- [Dynamic Adaptive](#)
- [Fixed Adaptive](#)
- [Static \(Fixed Range of Sensor Pixel Values\)](#)
- [Static \(Fixed Range of Scene Temperature\)](#)

For all contrast modes, values that fall outside the mapped range are rendered as 0 or 255.

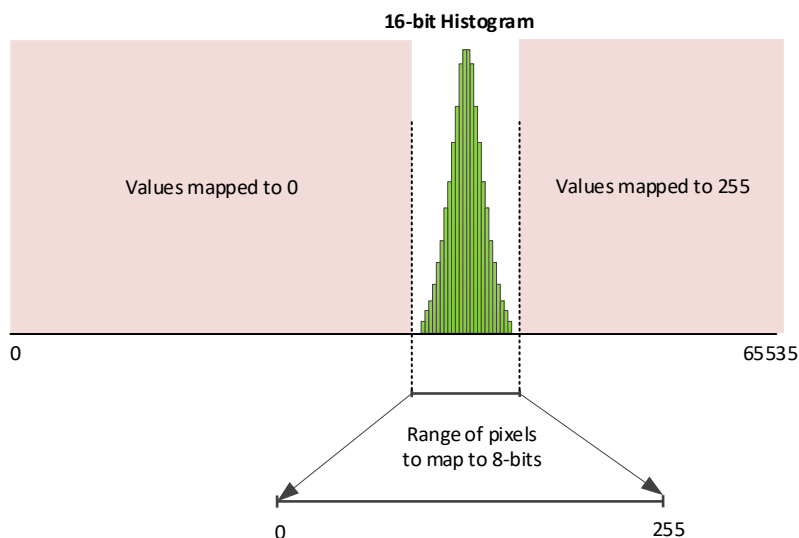

Figure 27: Contrast Enhancement Mapping 16-Bit to 8-bit

Adaptive modes analyze the 16-bit image to determine the average pixel value and then use this value to determine the DN values to map to 8-bits. Recommended contrast values for most applications is between 100 and 150. When contrast is set to the maximum value (255), the image is nearly binarized (pixels above the average value in the 16-bit image set to 255 and those below the average value set to 0).

When using adaptive modes, the image region used to calculate the contrast/brightness adjustments can be limited to a specific contrast zone (using the features available in the Contrast / Brightness category). This can be useful if the image scene contains distinct regions (for example, a horizon with sky and landscape) and the area of interest resides in one region; the contrast is then tailored to this specific region. When using a contrast zone, the resulting contrast is applied to the entire image.

### ***Dynamic Adaptive Mode***

The dynamic adaptive mode can be used when the scene contents vary from image to image to guarantee optimized contrast for 8-bit image output, regardless of scene content. The dynamic adaptive mode determines the range of values to map using the standard deviation from the current scene. The contrast setting (*contrast* feature) determines the number of standard deviations around this average value that are mapped to 8-bit values.

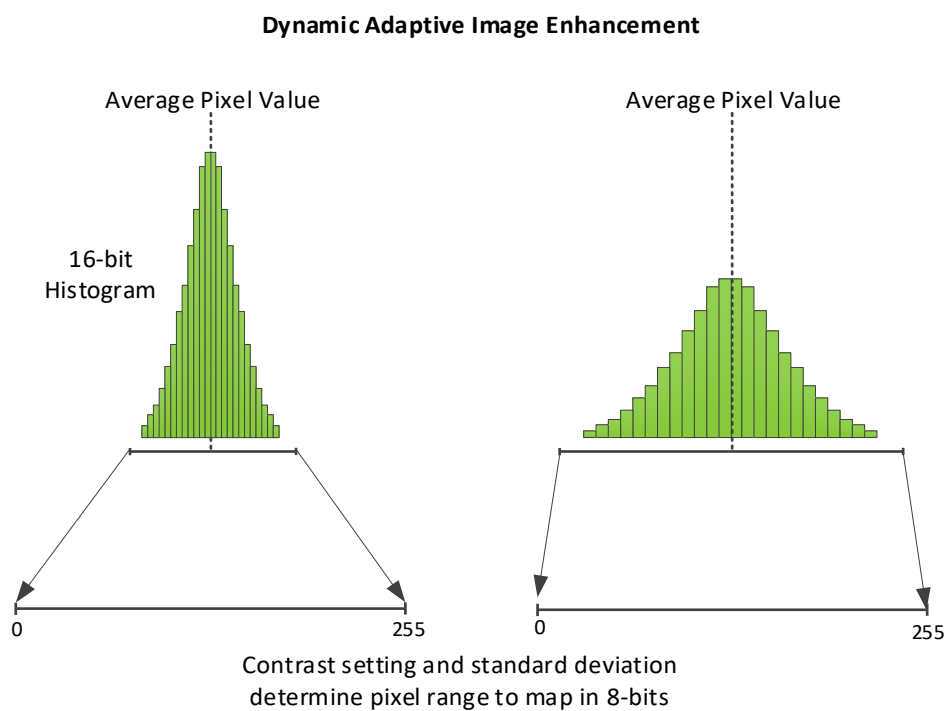

*Figure 28: Dynamic Adaptive Image Enhancement*

Table 9: Image Enhancement Dynamic Adaptive Contrast Examples

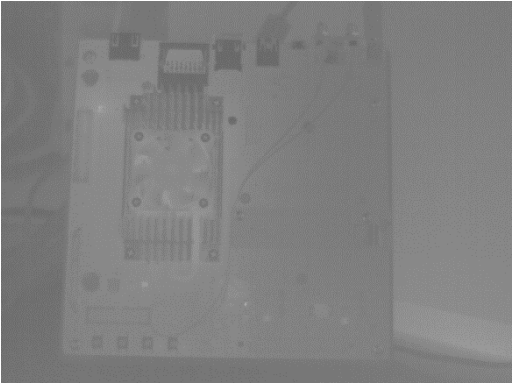
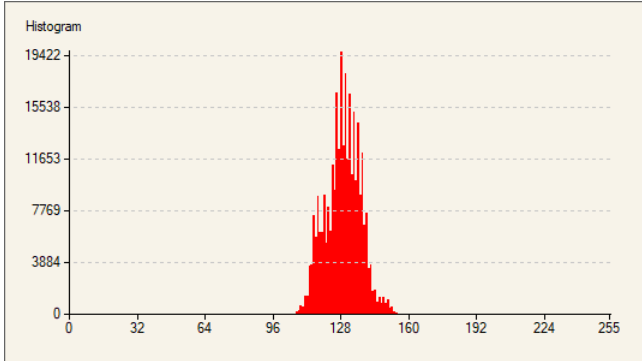
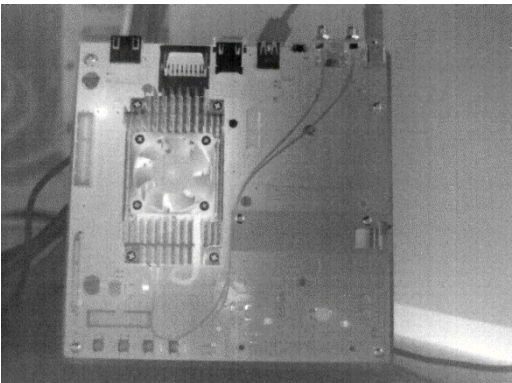
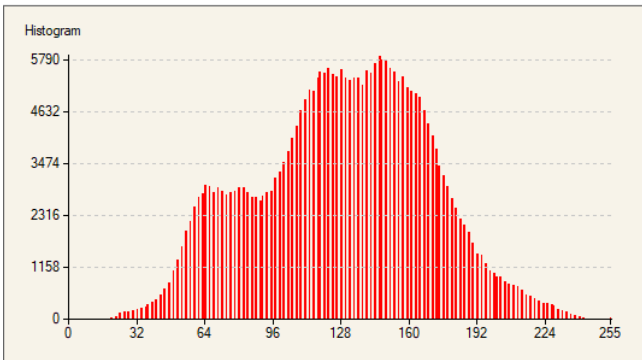
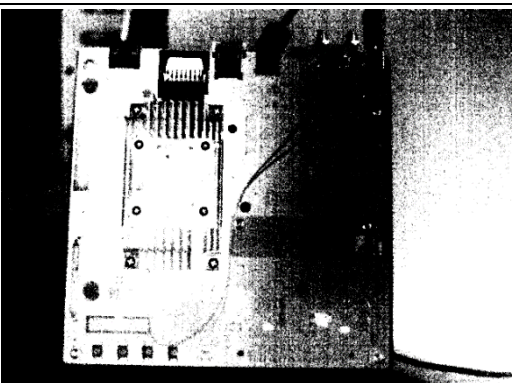
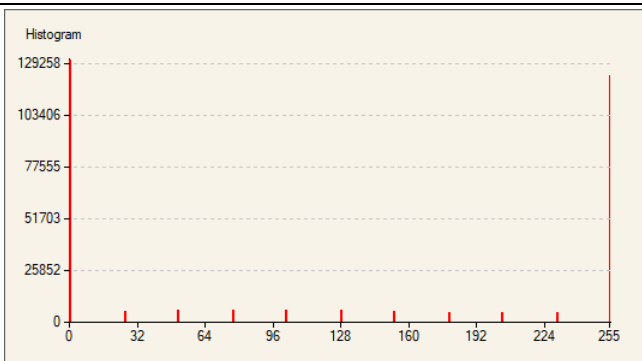
Image	8-bit image histogram
 <p data-bbox="268 667 568 696">Contrast = 1 (low contrast)</p>	 <p data-bbox="783 647 1353 676">Average value = 128.95; Standard Deviation = 8.32</p>
 <p data-bbox="236 1095 600 1124">Contrast = 128 (normal contrast)</p>	 <p data-bbox="775 1077 1362 1106">Average value = 128.06; Standard Deviation = 40.99</p>
 <p data-bbox="248 1525 584 1554">Contrast = 255 (high contrast)</p>	 <p data-bbox="767 1507 1369 1536">Average value = 123.68; Standard Deviation = 118.46</p>

## Maximum Gain

The maximum gain feature is used when the Contrast Mode ([contrastMode](#)) feature is set to Dynamic Adaptive (*AdaptiveDynamic*). This feature only applies when the 16-bit image has low contrast (image range is less than 255 DN). The maximum gain setting determines the smallest range of 16-bit values (around the average value) that can be stretched to fit 8-bits (0-255). For example, if a maximum gain of 10 is applied, a range of at least 25 pixel values are mapped to 8-bit values. A maximum gain of 1 limits the window of 16-bit values around the average to 256, while a gain of 0.5 limits the range to 512 values.

The maximum gain setting is useful for very low contrast scenes where the range of values in the 16-bit image is very small and the dynamic adaptive contrast enhancement would otherwise introduce noise and other image artifacts due to the small amount of data present.

To enable the maximum gain feature, use the [contrastMaxGainEnable](#) feature, and set the maximum gain value ([contrastMaxGainValue](#) feature).

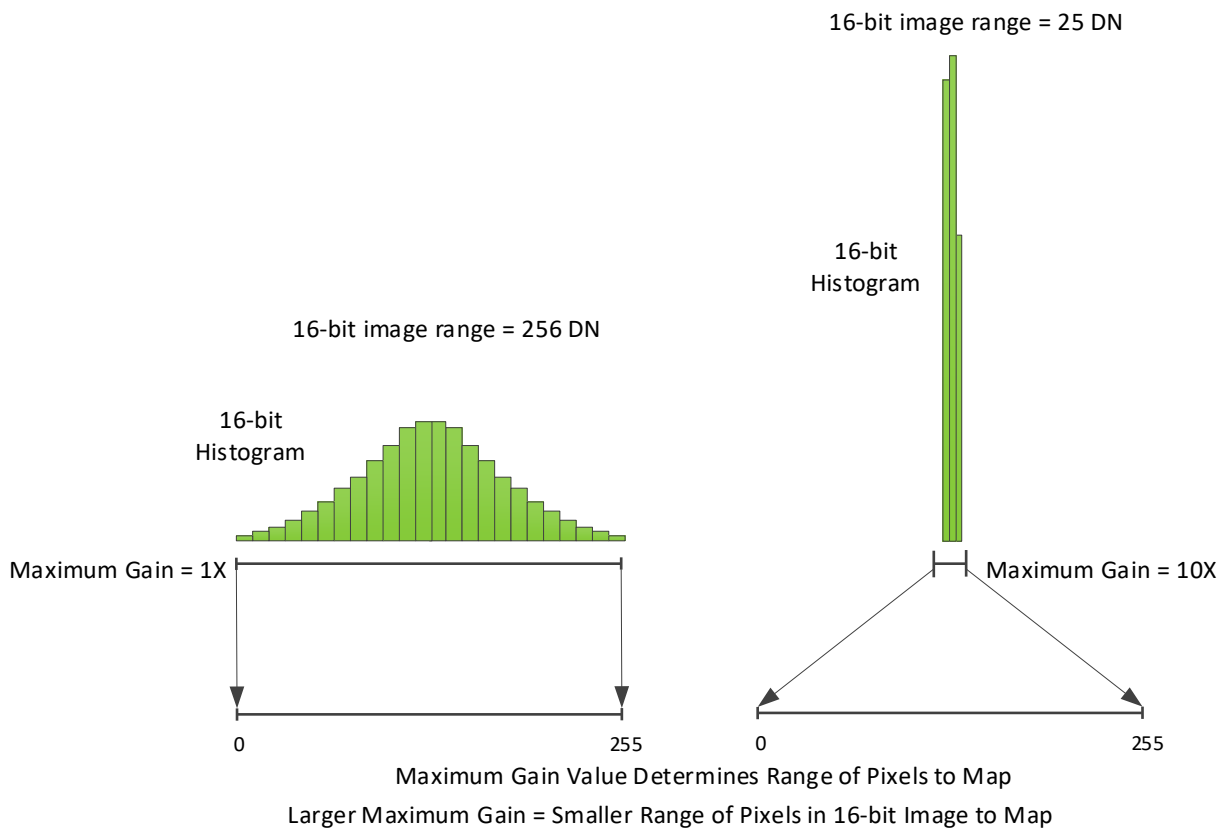
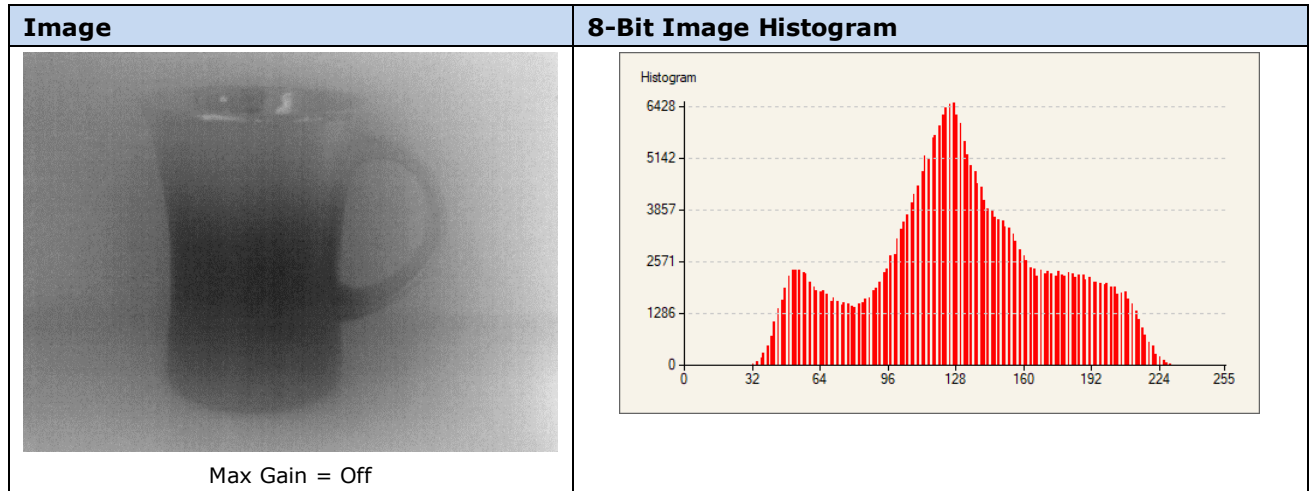

Figure 29: Contrast Enhancement Maximum Gain

For example, using the following sample image, the dynamic adaptive contrast mode stretches the image automatically (max gain feature = off) such that the resulting 8-bit image uses most of the dynamic range available (~215 DN) without saturating. This results from the fact that the dynamic adaptive contrast has calculated a gain of ~1.5 to apply to the image.

Table 10: Maximum Gain Off Example



If however, the maximum gain was set to 1, the 16-bit image would not be stretched and the max-min range remains the same in the 8-bit image.

Table 11: Maximum Gain Setting Examples

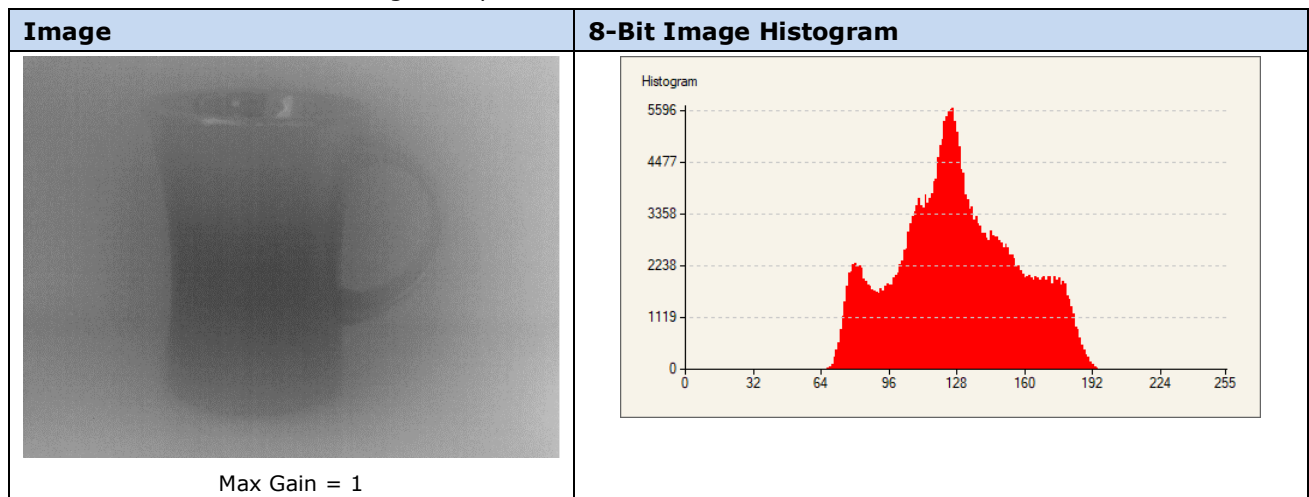

A maximum gain of less than 1 reduces the max-min range in the 16-bit image when mapping to 8-bits. For example, a maximum gain of 0.5 effectively reduces the 8-bit range in half from that present in the 16-bit image.

Table 12: Maximum Gain Setting 0.5 Example

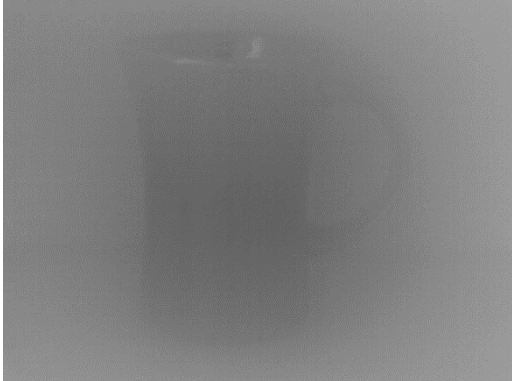
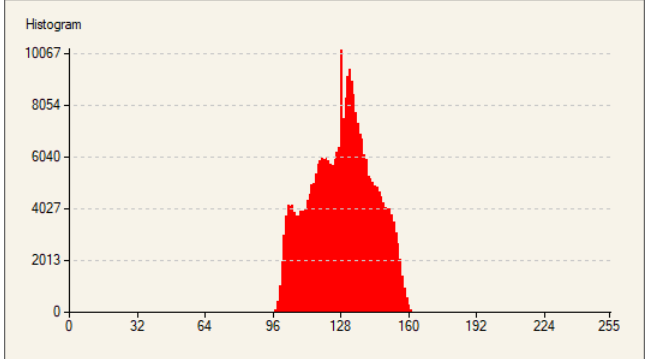
Image	8-Bit Image Histogram
 <p data-bbox="336 663 509 689">Max Gain = 0.5</p>	

**Fixed Adaptive Mode**

The fixed adaptive mode uses a fixed range based on the contrast setting to map pixels from 16-bit to 8-bit. The size of this range does not change, regardless of the scene content, ensuring a constant contrast. That is, the range moves with the average pixel value, whatever it is. Therefore, to ensure optimal mapping, use a contrast setting that best suits the expected scene.

**Fixed Adaptive Image Enhancement**

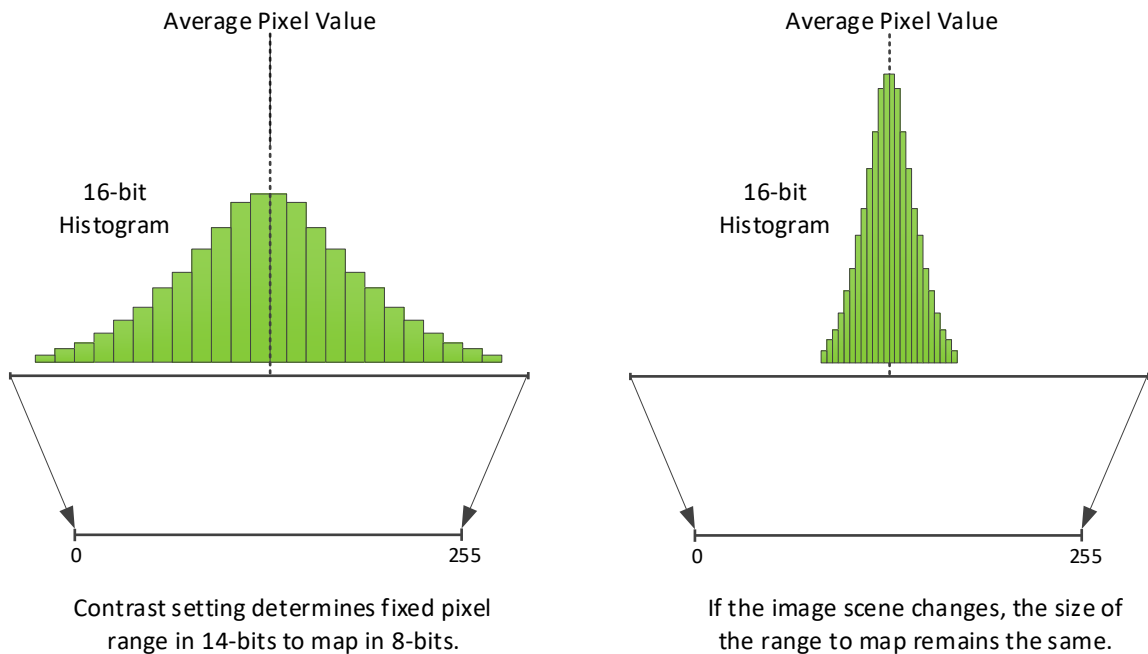

Figure 30: Fixed Adaptive Image Enhancement



The fixed adaptive mode also provides a Brightness (*brightness*) feature that shifts all pixel values higher (*brightness* > 128) or lower (*brightness* < 128).

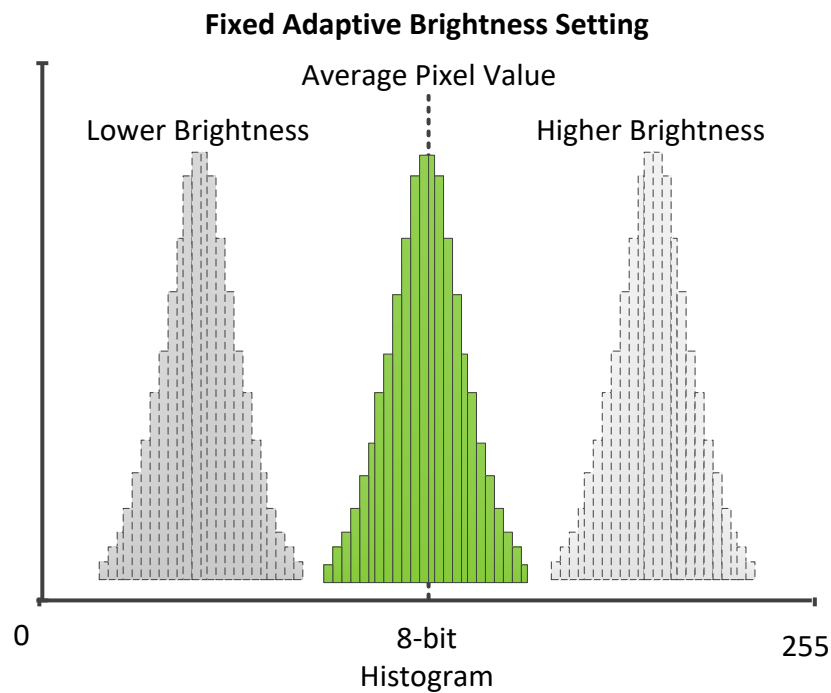

Figure 31: Fixed Adaptive Brightness Setting

This provides a mechanism to darken or brighten the image to reveal details from over-saturated or dark regions, while maintaining the contrast. For example, the following images show that lowering the brightness enhances the relevant details of the target object since the pixels reside in the upper range and effectively shifts the background darker.

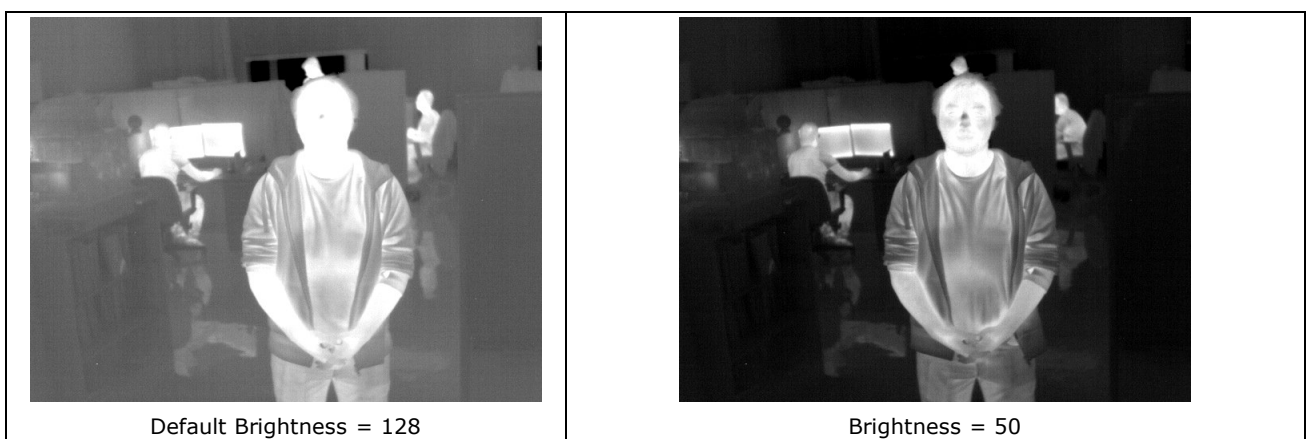



Figure 32: Fixed Adaptive Brightness Setting Example

**Static Contrast Mode (Fixed Range of DN Values)**

This is the camera operation used when the feature *contrastMode* is set to *Static*. This static contrast mode maps a fixed range in the 16-bit image to 8-bit values. The minimum and maximum input values (*contrastMinValue* and *contrastMaxValue* features) specify the range of values in the 16-bit image. If the image scene contents are known to always fall within a specific range, this mode can be used to provide consistent mapping of values.



**Note:** If the image pixel data moves outside this range, the information is lost and rendered as either 0 or 255 (pixel data below the range is mapped to 0, above the range mapped to 255).

For example, in the following image, the 16-bit histogram shows that the pixel range between the minimum and maximum values present is 3002 DN.

Table 13: Sample 16-Bit Image

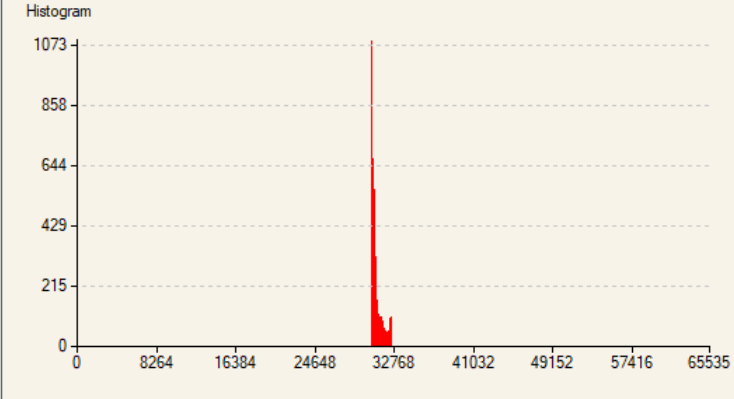
16-Bit Image	16-Bit Image Histogram																								
 <p style="text-align: center; margin-top: 10px;">8 LSB</p>	<div style="background-color: #2c4e64; color: white; padding: 2px;">Statistics</div> <div style="background-color: #f1f3f4; padding: 5px; margin-top: 5px;"> <p>Histogram</p>  <p style="font-size: small;">Selected view: <span style="border: 1px solid #ccc; padding: 2px;">Histogram</span>    Number of bins: <span style="border: 1px solid #ccc; padding: 2px;">65536</span></p> <p style="font-size: small;">Color selector: <span style="border: 1px solid #ccc; padding: 2px;">Gray</span></p> <table style="width: 100%; border-collapse: collapse; font-size: x-small;"> <thead> <tr style="border-bottom: 1px solid #ccc;"> <th style="text-align: left;">Coordinates</th> <th>Line</th> <th>Column</th> <th>Buffer</th> </tr> </thead> <tbody> <tr> <td>Line: <input style="width: 40px;" type="text" value="0"/></td> <td>0</td> <td>0</td> <td>30021</td> </tr> <tr> <td>Column: <input style="width: 40px;" type="text" value="0"/></td> <td>0</td> <td>0</td> <td>33023</td> </tr> <tr style="border: 2px solid red;"> <td style="border: 1px solid red;">Max - Min :</td> <td style="border: 1px solid red;">0</td> <td style="border: 1px solid red;">0</td> <td style="border: 1px solid red;">3002</td> </tr> <tr> <td>Average value:</td> <td>0.00</td> <td>0.00</td> <td>30840.61</td> </tr> <tr> <td>Standard deviation:</td> <td>0.00</td> <td>0.00</td> <td>516.88</td> </tr> </tbody> </table> <p style="text-align: right; margin-top: 5px;"><span style="border: 1px solid #ccc; padding: 2px 5px;">Close</span></p> </div>	Coordinates	Line	Column	Buffer	Line: <input style="width: 40px;" type="text" value="0"/>	0	0	30021	Column: <input style="width: 40px;" type="text" value="0"/>	0	0	33023	Max - Min :	0	0	3002	Average value:	0.00	0.00	30840.61	Standard deviation:	0.00	0.00	516.88
Coordinates	Line	Column	Buffer																						
Line: <input style="width: 40px;" type="text" value="0"/>	0	0	30021																						
Column: <input style="width: 40px;" type="text" value="0"/>	0	0	33023																						
Max - Min :	0	0	3002																						
Average value:	0.00	0.00	30840.61																						
Standard deviation:	0.00	0.00	516.88																						

Given the minimum and maximum values are 30021 and 33023, respectively, the static minimum and maximum gain values can be set accordingly, slightly outside this range so that the resulting image utilizes as wide a dynamic range as possible, without saturating at higher values or clipping at lower values..

Table 14: Static Contrast Mode Example

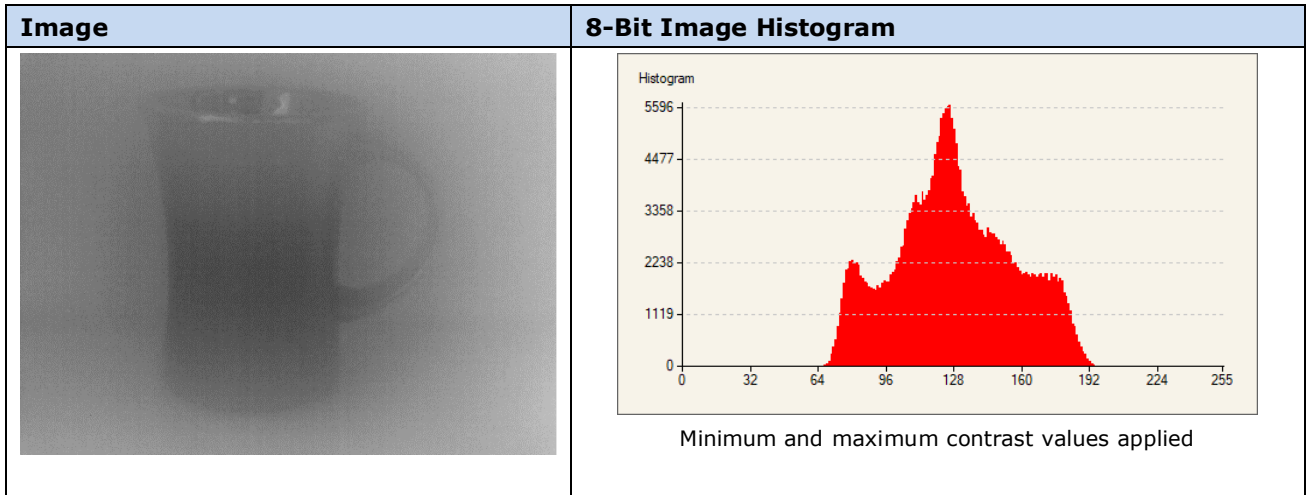

**Static Contrast Mode (Fixed Range of Scene Temperature)**

This is the camera operation used when feature [contrastMode](#) is set to *StaticTemperature*. This static contrast mode maps a fixed range of sensor pixel values to the 8-bit output image. But whereas the previous contrast mode ([contrastMode](#) = *Static*) explicitly requires configuring a range of DN values in the 16-bit input image, the *StaticTemperature* contrast mode is easier to configure using a range of scene temperatures. This range is set through the [contrastMinValueCelsius](#) and [contrastMaxValueCelsius](#) features. The camera automatically computes the associated values in the input 16-bit input image and reports them the [contrastMinValue](#) and [contrastMaxValue](#) features. Refer to [Converting Pixel Values to Temperatures](#) to see how the values of [contrastMinValue](#) and [contrastMaxValue](#) are computed.

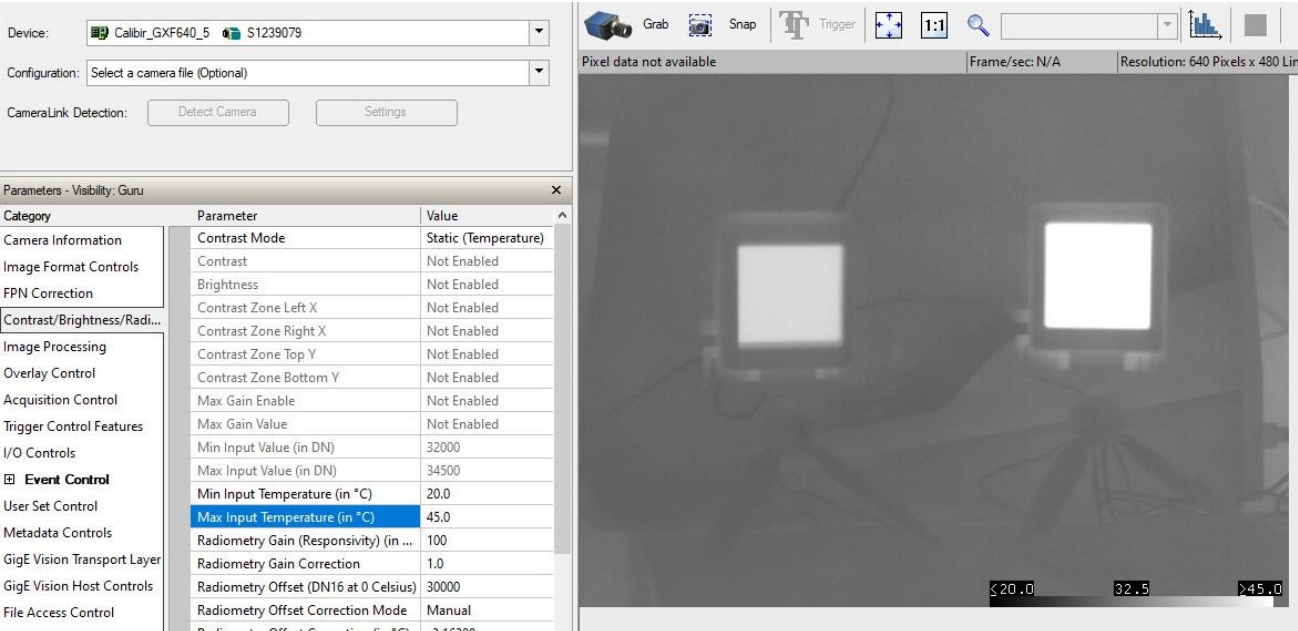

Category	Parameter	Value
Camera Information	Contrast Mode	Static (Temperature)
Image Format Controls	Contrast	Not Enabled
FPN Correction	Brightness	Not Enabled
Contrast/Brightness/Radi...	Contrast Zone Left X	Not Enabled
	Contrast Zone Right X	Not Enabled
	Contrast Zone Top Y	Not Enabled
	Contrast Zone Bottom Y	Not Enabled
Image Processing	Max Gain Enable	Not Enabled
	Max Gain Value	Not Enabled
Trigger Control Features	Min Input Value (in DN)	32000
	Max Input Value (in DN)	34500
I/O Controls	Min Input Temperature (in °C)	20.0
	Max Input Temperature (in °C)	45.0
Metadata Controls	Radiometry Gain (Responsivity) (in ...)	100
	Radiometry Gain Correction	1.0
GigE Vision Transport Layer	Radiometry Offset (DN16 at 0 Celsius)	30000
	Radiometry Offset Correction Mode	Manual
File Access Control	Radiometry Offset Correction (in °C)	-3.16308

The range of scene temperature will remain the same even if the polarity of the pixels is changed, though the Color Map overlay (if enabled) will be updated to reflect the new correspondence between pixel intensity and temperature:

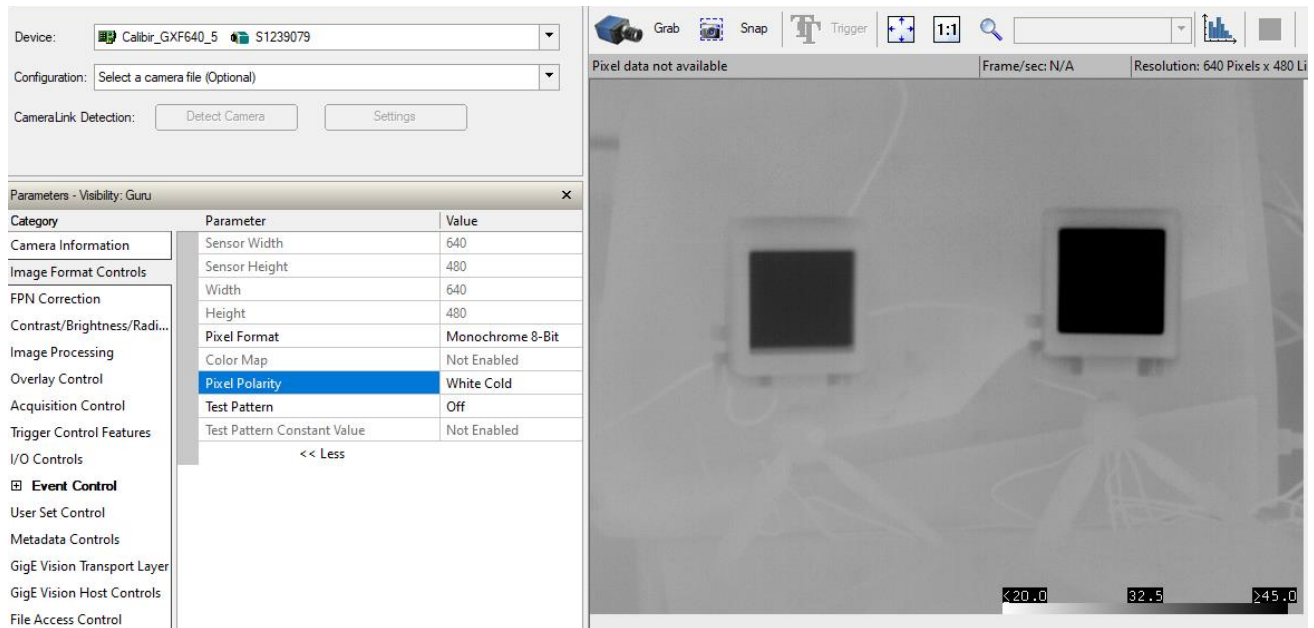

## Related GigE Vision Features

The Contrast / Brightness / Radiometry Category groups the related features: [contrastMode](#), [contrast](#), [brightness](#), [contrastMaxGainEnable](#), [contrastMaxGainValue](#), [contrastMinValue](#), [contrastMaxValue](#), [contrastMinValueCelsius](#) and [contrastMaxValueCelsius](#).

# Camera Synchronization

There are two schemes in which A68/A38 cameras can be configured to acquire images in synchronization with other cameras:

**Slave:** in this scheme, the A68/A38 camera waits for events; when the specified event is detected, a frame request is issued to the sensor and the resulting frame is output. Current cameras support two synchronization events:

- *External input frame trigger:* an electrical pulse on an input pin. The pulse must have a minimum (configurable) duration ([lineDebouncingPeriod](#)) to be considered valid, in order to provide some tolerance to line noise.
- *PTP trigger:* the A68/A38 can be configured to acquire images starting at a given time. When enabled ([ptpMode](#) = *Automatic*), PTP allows a common time base among multiple devices. Once a set time has been reached ([timestampModuloStartTime](#)), this triggers a PTP event that triggers the output of a frame. PTP events can then be generated automatically at a certain rate.

**Master:** in this scheme, the A68/A38 generates an electrical pulse on its output pin whenever it starts acquiring a frame. This pulse can be used for several purposes; for example, it can be used by other camera(s) to start exposure of their sensor, which provides for much more precise synchronization between cameras.

Cameras can be in free-running or in frame-on-demand mode; see the Sensor Readout Alignment Mode section for more information.



**Note:** Both Master and Slave schemes can be used simultaneously, in a daisy chain configuration. For example, an A68/A38 can be both a slave (wait for an external trigger pulse) and a master (generate a pulse to trigger another camera).

To enable the external input frame or PTP trigger, set the Trigger Mode ([TriggerMode](#)) feature, available in CamExpert in the Trigger Control Features category, to On.

Category	Parameter	Value
Camera Information	Sensor Readout Alignment Mode	FreeRunning
Image Format Controls	Trigger Selector	Frame Acquisition Trigger
Acquisition Control	Trigger Mode	On
Trigger Control Features	Software Trigger	Off
I/O Controls	Trigger Source	On
Event Control	Trigger Input Line Activation	Rising Edge
User Set Control	Timestamp Modulo Selector	Timestamp Modulo 1
Metadata Controls	Timestamp Modulo Event Start (in ns)	0
	Timestamp Modulo Event Period (in ns)	33333333

## Slave Configuration with External Input Frame Trigger

To enable the external input frame trigger, set the trigger source ([TriggerSource](#)) feature to Line 1. Line 1 is always asserted on the rising edge.

Category	Parameter	Value
Camera Information	Sensor Readout Alignment Mode	Free Running
Image Format Controls	Trigger Selector	Frame Acquisition Trigger
FPN Correction	Trigger Mode	On
Contrast / Brightness	Software Trigger	Not Enabled
Image Processing	Trigger Source	Line 1
Overlay Control	Trigger Input Line Activation	Line 1
Acquisition Control	Timestamp Modulo Selector	Timestamp Modulo Event 1
Trigger Control Features	Timestamp Modulo Event Start (in ns)	Timestamp Modulo Event 2
I/O Controls	Timestamp Modulo Event Period (in ns)	Software
		1000000000

For more information refer to the External Trigger section.

## Slave Configuration with PTP Trigger

To enable PTP, set the PTP Mode ([ptpMode](#)) feature, available in CamExpert in the Event Control category.

Category	Parameter	Value
Camera Information	Timestamp Source	IEEE1588 (PTP)
Image Format Controls	Timestamp	152109051380
Acquisition Control	Timestamp Latch	Press...
Trigger Control Features	Timestamp Latch Value	0
I/O Controls	Timestamp Reset	Press...
Event Control	Event Selector	Log (infos)
User Set Control	Event Notification	Off
Metadata Controls	PTP Mode	Automatic
GigE Vision Transport Layer	PTP Accuracy	Off
	PTP Status	Automatic

Use the Trigger Source ([TriggerSource](#)) feature to select the required timestamp modulo event (1 or 2), and set event start and period ([timestampModuloStartTime](#) and [timestampModulo](#) features).

Category	Parameter	Value
Camera Information	Sensor Readout Alignment Mode	FreeRunning
Image Format Controls	Trigger Selector	Frame Acquisition Trigger
Acquisition Control	Trigger Mode	On
Trigger Control Features	Software Trigger	Not Enabled
I/O Controls	Trigger Source	Timestamp Modulo Event 1
Event Control	Trigger Input Line Activation	Line 1
User Set Control	Timestamp Modulo Selector	Timestamp Modulo Event 1
Metadata Controls	Timestamp Modulo Event Start (in ns)	Timestamp Modulo Event 2
	Timestamp Modulo Event Period (in ns)	Software
		33333333

For more information on PTP refer to the Precision Time Protocol section; for more information on using external triggers refer to the External Trigger section.

## Master Configuration with Output Pulses

Under this configuration, the A68/A38 generates a pulse on its output pin (Line 2) when it starts acquiring an image. This pulse can be used to trigger the acquisition of a separate camera.

The A68/A38 I/O controls, as shown by CamExpert, includes features used to configure the generation of a pulse on an output pin. For more information on connecting an external output, see the 10-pin I/O Connector Details section.

Category	Parameter	Value
Camera Information	Line Status (All)	0x0000000000000000
Image Format Controls	Line Selector	Line 2
Acquisition Control	Line Name	Output1
Trigger Control Features	Connector Pin Numbers	IO_Pin6=GPO,IO_Pin4=CMN_P...
I/O Controls	Line Mode	Output
	Line Inverter	False
	Line Status	False
<input checked="" type="checkbox"/> Event Control	Output Line Source	Pulse on: Start of Readout
User Set Control	Line Format	Off
Metadata Controls	Line Detection Level	User Output 0
GigE Vision Transport Layer	Input Line Debouncing Period (in us)	Pulse on: Start of Readout
Contrast / Brightness	Output Line Pulse Duration (in us)	Pulse on: Timestamp Modulo 1
Image Processing	User Output Selector	Pulse on: Timestamp Modulo 2
Overlay Control	User Output Value	User Output 0
		False

## Related GigE Vision Features

The Trigger Control Features Category, I/O Controls Category and Event Control Category group the related features.

# External Trigger

FLIR A68/A38 series camera sensors support an external trigger input for frame acquisition, Counter control. Its status can be read for any required application. The external trigger source is Line 1; refer to the 10-pin I/O Connector Details for connection information. The trigger is asserted on the rising edge of the voltage transition. External signals are isolated by an opto-coupler input with a time programmable debounce circuit.

To enable the external trigger, set the Trigger Mode ([TriggerMode](#)) feature, available in CamExpert in the Trigger Control Features category, to On.

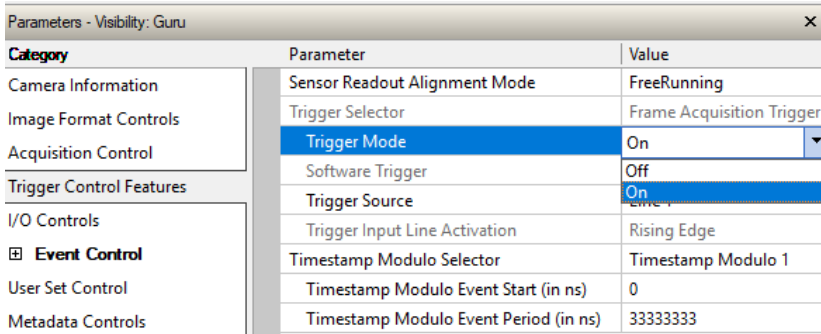

Category	Parameter	Value
Camera Information	Sensor Readout Alignment Mode	FreeRunning
Image Format Controls	Trigger Selector	Frame Acquisition Trigger
Acquisition Control	Trigger Mode	On
Trigger Control Features	Software Trigger	Off
I/O Controls	Trigger Source	Line 1
Event Control	Trigger Input Line Activation	Rising Edge
User Set Control	Timestamp Modulo Selector	Timestamp Modulo 1
Metadata Controls	Timestamp Modulo Event Start (in ns)	0
	Timestamp Modulo Event Period (in ns)	33333333

## Trigger Source

The external trigger can be generated by a variety of sources, such as an external input, software event or using a PTP timestamp modulo event (for more information on using PTP, refer to the Precision Time Protocol and Overview of Precision Time Protocol Mode (IEEE 1588) sections). The Trigger Source ([TriggerSource](#)) feature, sets the type of trigger.

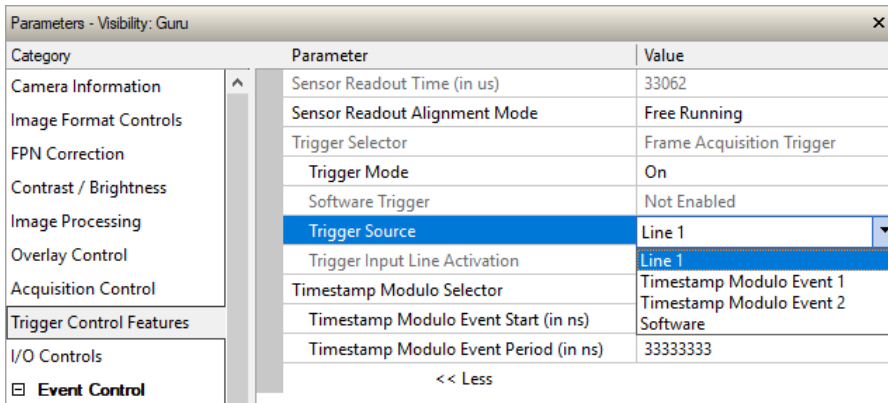

Category	Parameter	Value
Camera Information	Sensor Readout Time (in us)	33062
Image Format Controls	Sensor Readout Alignment Mode	Free Running
FPN Correction	Trigger Selector	Frame Acquisition Trigger
Contrast / Brightness	Trigger Mode	On
Image Processing	Software Trigger	Not Enabled
Overlay Control	Trigger Source	Line 1
Acquisition Control	Trigger Input Line Activation	Line 1
Trigger Control Features	Timestamp Modulo Selector	Timestamp Modulo Event 1
I/O Controls	Timestamp Modulo Event Start (in ns)	Timestamp Modulo Event 2
Event Control	Timestamp Modulo Event Period (in ns)	Software
		33333333



## Input Line Debouncing Period

The Input Line Debouncing Period ([lineDebouncingPeriod](#)) feature, available in CamExpert in the I/O Controls category, specifies the minimum length of time the input pin must be held high to be considered a valid trigger; triggers shorter than the minimum input debounce time are ignored. This can be disabled by setting the Input Line Debouncing Period feature ([lineDebouncingPeriod](#)) to 0.

Category	Parameter	Value
Camera Information	Line Status (All)	0x0000000000000000
Image Format Controls	Line Selector	Line 1
Acquisition Control	Line Name	Input1
Trigger Control Features	Connector Pin Numbers	IO_Pin5=GPI,IO_Pin3=CMN_GND
I/O Controls	Line Mode	Input
Event Control	Line Inverter	False
User Set Control	Line Status	False
Metadata Controls	Output Line Source	Not Enabled
GigE Vision Transport Layer	Line Format	Optocoupled
Contrast / Brightness	Line Detection Level	2.4 V
Image Processing	Input Line Debouncing Period (in us)	5
Overlay Control	Output Line Pulse Duration (in us)	Not Enabled
	User Output Selector	User Output 0
	User Output Value	False

When a valid trigger is received, the next available frame is acquired and any subsequent triggers received before the start of the frame are ignored.

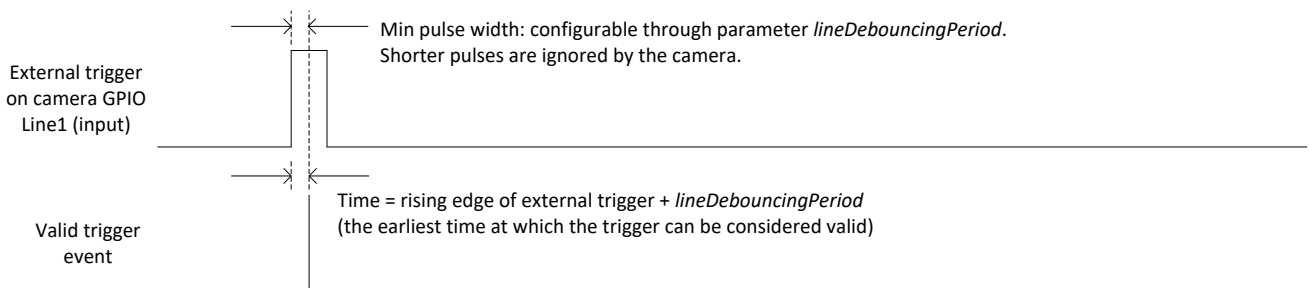

An invalid frame (rejected) trigger counter is available, in the Event Control feature category, that counts the frame triggers occurring in an invalid trigger region. To monitor the counter, select Invalid Frame Trigger (*InvalidFrameTrigger*) using the Event Statistic Selector ([eventStatisticSelector](#)) feature and read the Event Count ([eventStatisticCount](#)) feature. Alternatively, the invalid frame counter is also available in the image metadata; refer to the Metadata section for more information.

Category	Parameter	Value
Camera Information	Event Statistic Selector	Invalid Frame Trigger
Image Format Controls	Event Count	Packet Resend
FPN Correction	Timestamp Source	Packet Resend Request Dropped
Contrast / Brightness	Timestamp	Invalid Frame Trigger
Image Processing	Timestamp Latch	Image Lost
Overlay Control	Timestamp Latch Value	Ethernet Pause Frame Received
Acquisition Control	Timestamp Reset	0
Trigger Control Features	Event Selector	Press...
I/O Controls	Event Notification	Alarm 3
Event Control	PTP Mode	Off
	PTP Accuracy	Off
	PTP Accuracy	10 us
	PTP Accuracy	Disabled

# Sensor Readout Alignment Mode

The Sensor Readout Alignment Mode ([readoutAlignment](#)) feature, available in CamExpert in the Trigger Control Features category, sets whether the camera is in free running mode or in frame-on-demand mode.

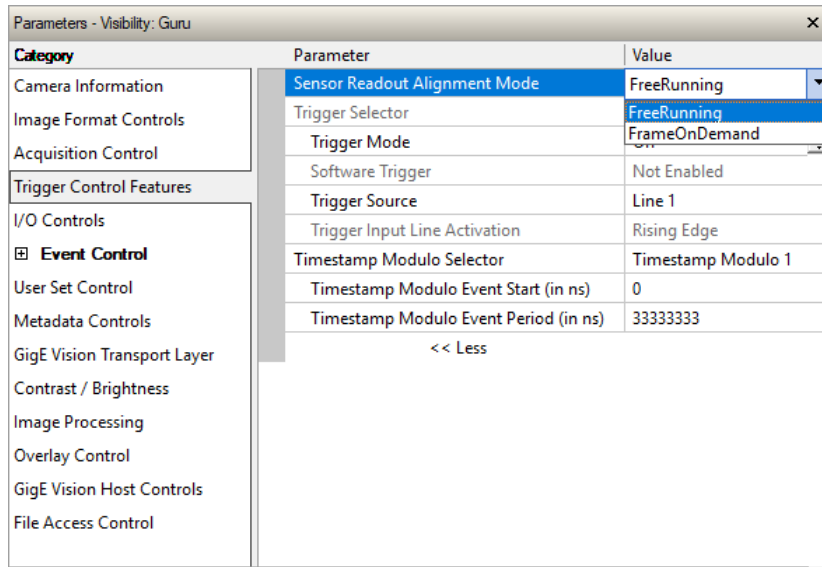

## Free-Running Mode

In free-running mode, the camera is constantly acquiring frames at 30fps asynchronously (frame period = 33.333ms). When using the camera's internal trigger ([TriggerMode](#) = Off), the camera continuously transfers frames to the host after the camera receives the [AcquisitionStart](#) command.

With triggers enabled ([TriggerMode](#) = On), when a valid trigger is received, the next available frame is transferred. Any subsequent triggers received during this frame acquisition and readout are ignored. Without a trigger, no frames are transferred but the camera continues to acquire images.

## Free-Running Mode Using External Triggers

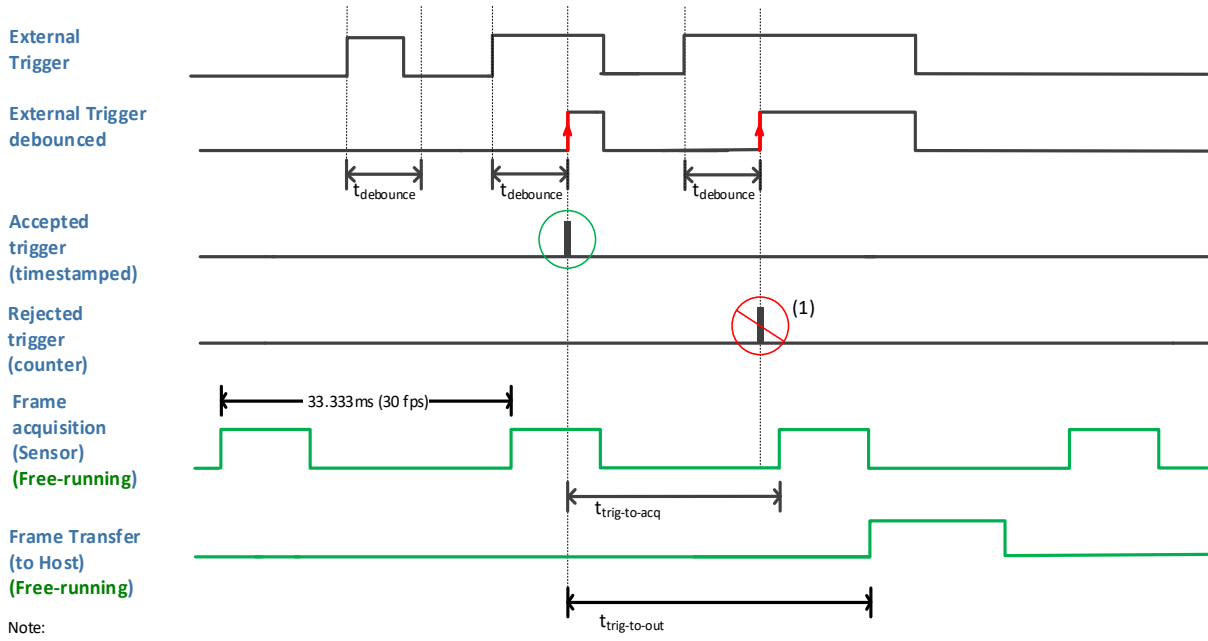

Note:  
 (1) This second detected trigger is rejected because already one has been detected in the same frame acquisition period. Consequently this trigger is not timestamped.

Figure 33: External Trigger Wave Diagram: Free-Running

Although the frame acquisition timing is dependent on when the camera receives the [AcquisitionStart](#) command and starts acquiring images, external triggers can be synchronized with the start of frame pulse available on output Line 2.

Category	Parameter	Value
Camera Information	Line Status (All)	0x0000000000000000
Image Format Controls	Line Selector	Line 2
Acquisition Control	Line Name	Output1
Trigger Control Features	Connector Pin Numbers	IO_Pin6=GPO,IO_Pin4=CMN_PWR
I/O Controls	Line Mode	Output
	Line Inverter	False
	Line Status	False
<b>Event Control</b>	Output Line Source	Pulse on: Start of Readout
User Set Control	Line Format	Off
Metadata Controls	Line Detection Level	User Output 0
GigE Vision Transport Layer	Input Line Debouncing Period (in us)	Pulse on: Start of Readout
Contrast / Brightness	Output Line Pulse Duration (in us)	Pulse on: Timestamp Modulo 1
Image Processing	User Output Selector	User Output 0
Overlay Control	User Output Value	False

## Frame-on-Demand Mode

In frame-on-demand mode, the camera sensor outputs frames when a valid trigger is received.

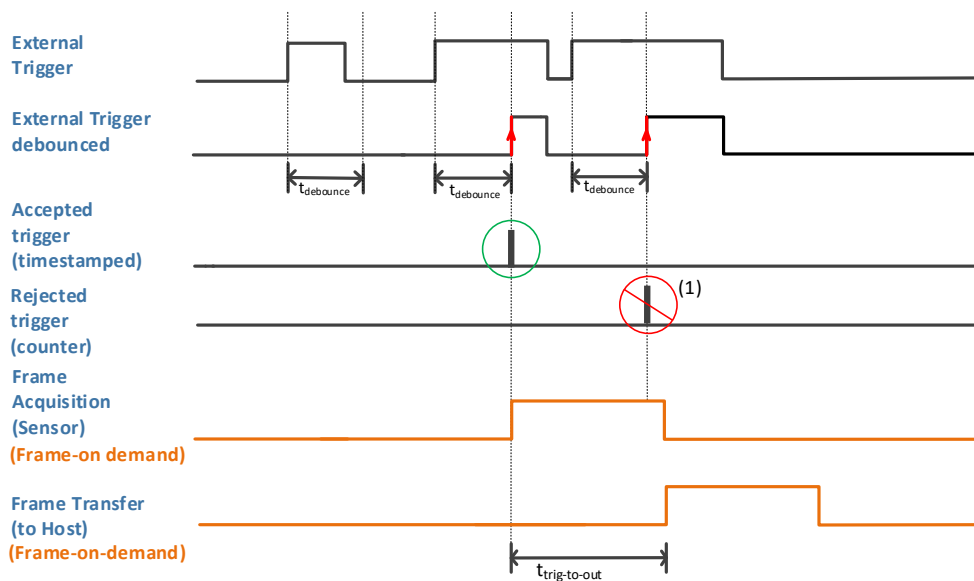

Note:

(1) This second detected trigger is rejected because already one has been detected in the same frame acquisition period. Consequently this trigger is not timestamped.

Figure 34: External Trigger Wave Diagram: Frame-On-Demand



**Note:** The maximum frame rate period achievable using this mode is 33.233 ms; if triggers are received faster than this rate they are ignored. In addition, since the non-uniformity correction (NUC) applied is factory-calibrated at 30fps, triggering at a different frame rate may result in less optimal shutterless operation. In this case, FPN correction can be applied.

If the triggered acquisition is from a cold start, the first few images might be of lower quality as the sensor heats up. When triggering at a constant rate, the trigger frequency must be stable enough to maintain a constant temperature; if the interval between frames varies, the quality of the image may be affected.

## Related GigE Vision Features

External trigger features are part of the Trigger Control Features and I/O Controls categories; for complete feature descriptions refer to the Trigger Control Features Category and I/O Controls Category sections.

---

## Precision Time Protocol

The FLIR A68/A38 series supports IEEE 1588 Precise Time Protocol (PTP) which provides a method for synchronizing devices over a Local Area Network (LAN). PTP is capable of synchronizing multiple clocks to microsecond accuracy on a network specifically designed for IEEE-1588. One device clock is considered the master, and multiple slave devices synchronize their clocks to the master; this allows timestamps to be consistent across the network.

### PTP Synchronization

When more than one device on a LAN is PTP enabled, the IEEE 1588 protocol uses the Best Master Clock algorithm (refer to the protocol documentation for more information) to automatically determine which clock in the network is the most precise. It becomes the PTP master clock. All other clocks become PTP slaves and synchronize their clocks with the PTP master.

To synchronize, the PTP master clock periodically broadcasts synchronization messages that the PTP slaves use to correct their local clocks. Message timestamps are used to precisely determine the time at which a message was sent by the PTP master, and the time at which it was received by the PTP slave. The time difference is a combination of the clock offset (between PTP master and PTP slave) and network transmission delay.

When a PTP slave receives a synchronization message from the PTP master, it updates its local clock in two ways:

- It adjusts its clock offset to compensate to past errors;
- It adjusts its own clock speed, to reduce future errors. When the PTP slave detects that its clock is consistently lagging behind or accelerating ahead of the PTP master's clock, it will adjust its own clock speed to match the PTP master's clock speed.

### Hardware Considerations

#### *Ethernet Switches*

Ethernet switches can be categorized as standard Ethernet switches and IEEE-1588 enabled Ethernet switches. A standard Ethernet switch temporarily stores packets before sending them out. The storing time of the packet is non-deterministic and depends on network load, resulting in packet delay variation. The packet delay variation is the primary reason that standard Ethernet switches result in poor time synchronization even when the master and slave clock support hardware timestamping.

An IEEE-1588 enabled switch is a transparent clock. Using a transparent clock improves synchronization between the master and slave and ensures that the master and slave are not impacted by the effects of packet delay variation.

## ***PTP Grandmaster Clock***

A PTP grandmaster clock is an external device that can provide a high precision clock source to the other PTP-enabled devices on the local network. Depending on the application, it is not necessary to provide such a device; if multiple A68/A38 (and/or Teledyne Genie Nano-GigE) cameras are present in a subnet, automatically one of the cameras will be selected to be the clock source for the other cameras.

When using an external PTP grandmaster clock, please make sure that its PTP Sync Rate respects the IEEE 1588-2008 standard, that is, no higher than 10 Sync messages per second. Some PTP grandmaster clocks are configured by default to provide 128 Sync messages per second which is higher than what the A68/A38 can sustain. For reference, when a A68/A38 camera operates as a PTP clock source, it sends out one Sync message per second and this is sufficient to provide precision within a few microseconds.

## **PTP Configuration Features**

Features are available to configure PTP behavior and compensate for network topologies that include standard Ethernet switches (without PTP transparent mode support) which can introduce large, non-deterministic variations in the reception of PTP packets. These features provide more tolerance to variations in network transmission time of PTP packets.

### ***Outlier Detection***

When the camera receives a PTP sync messages from the master, if the difference in timestamps (Master to Slave difference) is outside acceptable limits ([\*ptpServoStepThreshold\*](#)), it is flagged as an "outlier" and ignored.

If the camera receives a large number of outliers, it is assumed that an event has occurred on the ethernet network that makes it temporarily too unstable for the PTP algorithm to run. In this case, the A68/A38 reverts its clock speed to its normal, non-adjusted value and restarts acquiring statistics on the PTP master, that is, it enters the synchronization state.

The [\*ptpSyncHistorySize\*](#) feature determines the number of PTP sync messages saved, both valid and outlier; if the number of valid PTP sync in the history falls below the minimum number of valid PTP sync messages ([\*ptpSyncMinCount\*](#)) required, the camera reverts back to the Synchronizing state.

To reduce the impact of large adjustments that are still within the outlier threshold, a user-configurable fraction of the timestamp difference ([\*ptpClockOffsetAdjustFactor\*](#) and [\*ptpClockSpeedAdjustFactor\*](#)) can be used to perform the slave clock offset and speed corrections. In addition, an upper limit to the size of the corrections can be applied ([\*ptpClockOffsetMaxAdjust\*](#) and [\*ptpClockSpeedMaxAdjust\*](#)).

## **Related GigE Vision Features**

PTP-related features are part of the Event Control feature category; for complete feature descriptions refer to the Event Control Feature Descriptions.

# Internal Test Pattern Generator

The FLIR A68/A38 series cameras include a number of internal test patterns which can easily confirm if camera installations are setup correctly. The internal test patterns are generated by the camera FPGA.

To use a test pattern, select a test pattern using the [TestPattern](#) feature, available in the Image Format Controls Category.

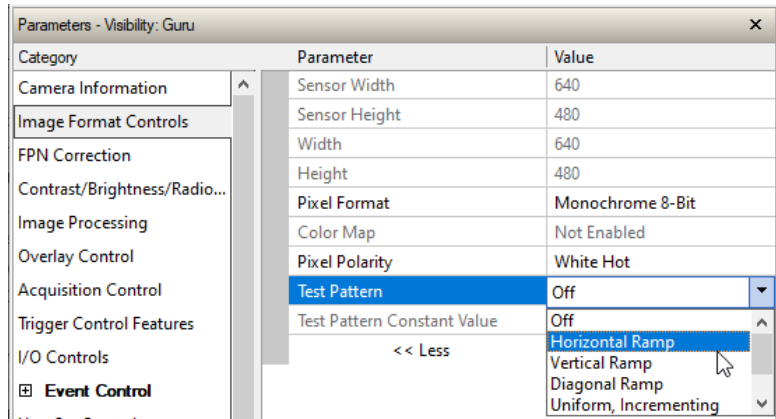

## A68/A38 Test Patterns

### ***Horizontal ramp:***

Image is filled horizontally with an image that goes from the darkest possible value to the brightest.



Figure 35: Horizontal Ramp Test Pattern

### ***Vertical ramp:***

Image is filled vertically with an image that goes from the darkest possible value to the brightest.



Figure 36: Vertical Ramp Test Pattern

### ***Diagonal ramp:***

Combination of the horizontal and vertical ramps.



Figure 37: Diagonal Ramp Test Pattern

**Constant:**

All pixels in image stay at a defined value.

**Constant, Incrementing:**

All pixels in image increment by 1 between successive frames, going from darkest possible value to the brightest.

**User-Defined:**

A user-defined test image (.bmp file, 640 x 480, mono8) can be uploaded to the camera and selected as the test pattern. The file access features, available in the File Access Control Category, can be used to upload the image using the CamExpert File Access Control dialog:

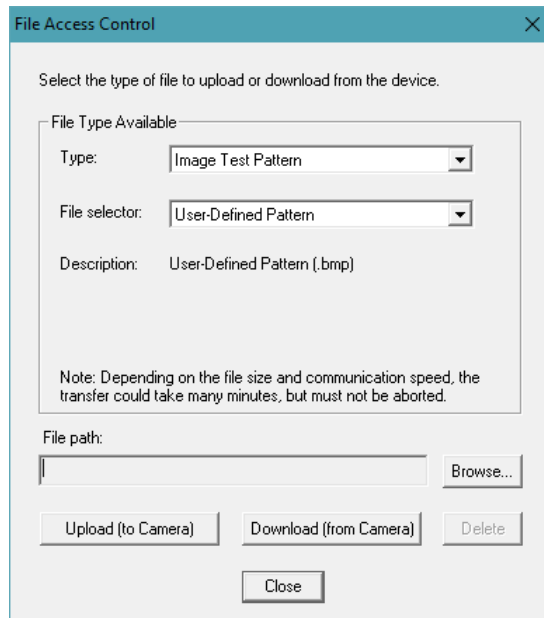

Figure 38: File Access Control Dialog

## Related GigE Vision Features

For the FLIR A68/A38 series, the [TestPattern](#) feature selects the test pattern to output; for complete feature descriptions refer to the Image Format Controls Category



---

## Temperature Sensors

The FLIR A68/A38 series cameras are equipped with several temperature sensors that can be read to verify the current operating temperature, in Celsius.

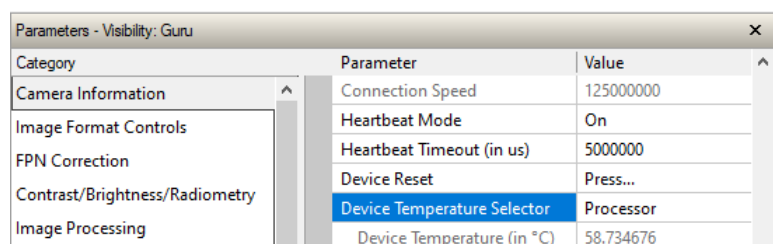

Category	Parameter	Value
Camera Information	Connection Speed	125000000
Image Format Controls	Heartbeat Mode	On
FPN Correction	Heartbeat Timeout (in us)	5000000
Contrast/Brightness/Radiometry	Device Reset	Press...
Image Processing	<b>Device Temperature Selector</b>	<b>Processor</b>
	Device Temperature (in °C)	58.734676

Available sensors are:

- **Processor:** core chip
- **Sensor:** estimated temperature of the microbolometer
- **Ethernet PHY:** Ethernet chip

### Related GigE Vision Features

The [DeviceTemperatureSelector](#) and [DeviceTemperature](#) features are used to read the temperature sensors and are part of the Camera Information Category.

---

## Error Log File

In the rare event that a crash occurs in the camera, the current application log is immediately saved to non-volatile memory. The A68/A38 will then immediately reboot in order to keep downtime to an absolute minimum. The contents of the error log can be sent to Technical Support for investigation.

FLIR A68/A38 series cameras reserves enough space in non-volatile memory for 4 error log files. If all 4 error log memory locations are used, no new error logs are written to non-volatile memory; to enable writing of new error logs, the error logs must be cleared.

## Related GigE Vision Features

The [crashLogCount](#) feature returns the current number of crashes; for complete feature descriptions refer to the Camera Information Category section. The error log is downloaded using the [File Access Control](#) dialog. Select the "Miscellaneous" file type and "Error Log" as the file.

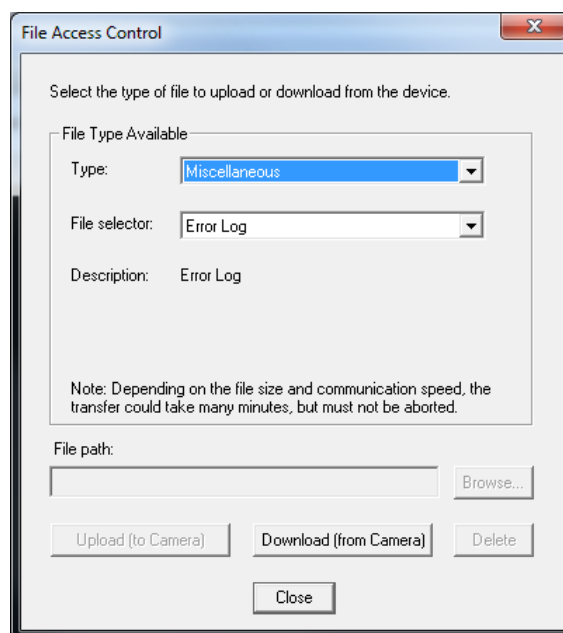

Figure 39: File Access Control Dialog

Writing 1 to the [crashLogReset](#) feature clears crash logs in flash memory; for complete feature descriptions refer to the Camera Information Category.

# Operational Reference

---

## Using a FLIR A68/A38 Series Camera with Sopera API

A68/A38 camera installation with the Teledyne DALSA Sopera API generally follows the sequence described below.

### Network and Computer Overview

A68/A38 needs to connect to a computer with a **GigE network adapter**, either built in on the computer motherboard or installed as a third-party PCI adapter. Refer to the Connecting the FLIR A68/A38 Series GigE Vision Camera section.

- **Laptop computers** with built in **GigE network adapters** may still not be able to stream full frame rates from A68/A38, especially when on battery power.
- A68/A38 also can connect through a **Gigabit Ethernet switch**. When using VLAN groups, the A68/A38 and controlling computer must be in the same group (refer to the Teledyne DALSA Network Imaging Package user's manual).
- If A68/A38 is to be used in a **Sopera development environment**, Sopera LT 8.41 or greater needs to be installed, which includes the **GigE Vision Module** software package.
- If A68/A38 will be used in a **third-party GigE Vision Compliant environment**, Sopera or Sopera runtime is not required and you need to follow the installation instructions of the third-party package.
- The **Windows Firewall** exceptions feature is automatically configured to allow the Sopera GigE Server to pass through the firewall.
- Computers with **VPN software** (virtual private network) may need to have the VPN driver disabled in the NIC properties. This would be required only on the NIC used with the A68/A38. Testing by the user is required.
- Once an A68/A38 is connected, look at the small camera icon added to the Windows tray (next to the clock). Ensure the A68/A38 camera has been found (right click the icon and select Status). Note that in Windows 7, the icon remains hidden until a camera is connected.
- A new A68/A38 installation may require a firmware update. The [File Selector](#) feature is used to select a firmware file. See the CamExpert procedure Updating Firmware via File Access in CamExpert for additional information.
- Use CamExpert (installed either with Sopera or Sopera runtime) to test the installation of the A68/A38 camera. Set the A68/A38 to internal test pattern. See the Internal Test Pattern Generator section.

## Installing Sopera LT



**Note:** To install Sopera LT and the GigE Vision package, logon to the workstation as an administrator or with an account that has administrator privileges.

When A68/A38 is used in a **Sopera development environment**, **Sopera LT 8.41 or greater** needs to be installed, which automatically provides all GigE Vision camera support.

If no Sopera development is required, then the Sopera LT SDK is not needed to control the A68/A38 camera. Sopera runtime with CamExpert provides everything to control the camera.

### *Procedure*

- Download and install Sopera 8.41 or greater which automatically provides GigE Vision support.
- Connect the camera to an available Gigabit NIC.

Refer to Sopera LT User's Manual concerning application development with Sopera.



**Note:** The Teledyne DALSA Sopera CamExpert tool (used throughout this manual to describe A68/A38 features) is installed with either the Sopera LT runtime or the Sopera LT development package.

## Camera Firmware Updates

Under Windows, the user can upload new firmware, downloaded from Teledyne DALSA support, using the [File Access Control](#) features provided by the Sopera CamExpert tool.



## Firmware via Linux or Third-Party Tools

Consult your third-party GigE Vision software package for file uploads to the connected device.

## GigE Server Verification

After a successful Sapera Network Imaging package installation, the GigE Server icon is visible in the desktop taskbar tray area (note that in Windows 7 the icon remains hidden until a camera is connected). After connecting a camera (see following section), allow a few seconds for the GigE Server status to update. The A68/A38 camera must be on the same subnet as the NIC to be recognized by the GigE Server.

Table 15: GigE Server Tray Icon States

	Device Available	Device IP Error	Device Not Available
<b>GigE Server Tray Icon:</b>			
	The normal GigE server tray icon when the a device is found. It will take a few seconds for the GigE Server to refresh its state after the A68/A38 has obtained an IP address.	The GigE server tray icon shows a warning when a device is connected but there is some type of IP error.	A red X will remain over the GigE server tray icon when the a device is not found. This indicates a major network issue. <b>Or in the simplest case</b> , the device is not connected.

If you place your mouse cursor on this icon, the GigE Server will display the number of GigE Vision devices found by your PC. Right click the icon and select status to view information about those devices. See the [Troubleshooting](#) section for more information.



Figure 40: GigE Server Tray Icon

## GigE Server Status

Once the A68/A38 is assigned an IP address (its Status LED is steady blue) the GigE server tray icon will not have a red X through it, indicating that the A68/A38 device was found. It might take a few seconds for the GigE Server to refresh its state after the A68/A38 has obtained an IP address.

Right-click the GigE Server tray icon to open the following menu:

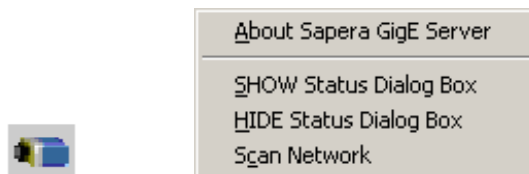

Figure 41: GigE Pop-up Menu

Click on **Show Status** to open a window listing all devices connected to the host system. Each GigE device is listed by name along with important information such as the assigned IP address and device MAC address. The screen shot below shows a connected A68/A38 with no networking problems.

Manufacturer	Model	Serial number	MAC address	Status	Camera IP	NIC IP	Filter driver	MaxPktSize	User name
Teledyne FLIR	800-00016-00	S11111111	00:01:0D:12:E6:00	Connected	172.16.239.14	172.16.239.1	Enable	1500	FLIR

Figure 42: GigE Vision Device Status

In the event that the device is physically connected, but the Sopera GigE Server icon is indicating that the connected device is not recognized, click Scan Network to restart the discovery process. Note that the GigE server periodically scans the network automatically to refresh its state. See the [Troubleshooting](#) section for network problems.

## Optimizing the Network Adapter used with A68/A38

Most Gigabit network interface controllers (NIC) allow user modifications to parameters such as Adapter Buffers. These should be optimized for use with the A68/A38 during the installation. Refer to the **Teledyne DALSA Network Imaging package manual** for optimization information using the Network Configuration Tool.

## Quick Test with CamExpert (Windows)

When the A68/A38 camera is connected to a Gigabit network adapter on a host computer, testing the installation with CamExpert is a straightforward procedure.

- Start Sopera CamExpert by double clicking the desktop icon created during the software installation.
- CamExpert will search for installed Sopera devices. In the Device list area on the left side, the connected A68/A38 camera is shown or will be listed in a few seconds after CamExpert completes the automatic device search (device discovery).
- Select the A68/A38 camera device by clicking on the camera user defined name. By default the A68/A38 camera is identified by its serial number. The A68/A38 status LED will turn light blue, indicating the CamExpert application is now connected.
- Click on the Grab button for live acquisition (the A68/A38 default is Free Running mode). Focus and adjust the lens iris. See [Operational Reference](#) for information on CamExpert parameters with the A68/A38 camera.
- If the A68/A38 has no lens, just select one of the internal test patterns available ([Test Image Selector](#)). All but one are static images to use with the Snap or Grab function of CamExpert.
- Refer to the Teledyne DALSA Network Imaging package manual if error messages are shown in the Output Messages pane while grabbing.

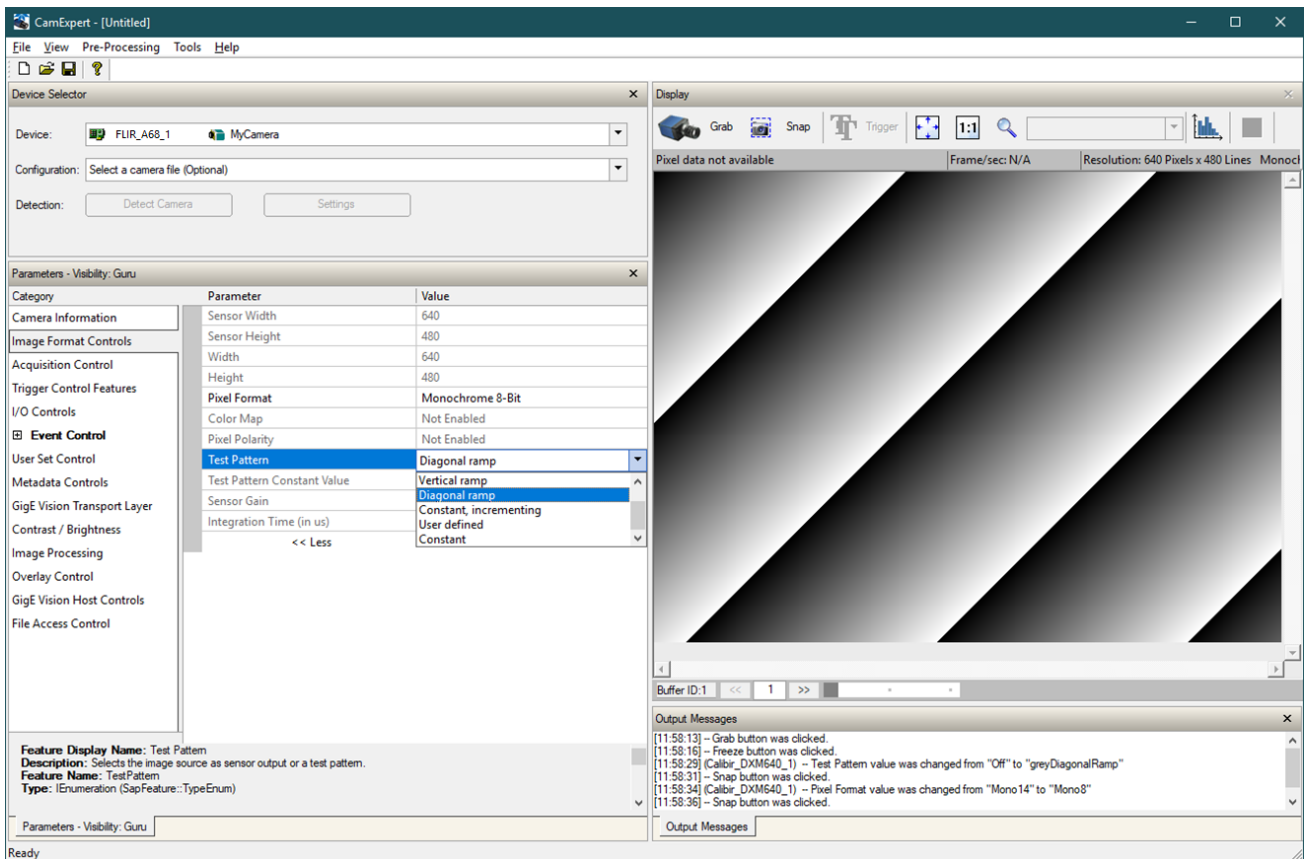

Figure 43: Sapera CamExpert

## About the Device User ID

The A68/A38 can be programmed with a user defined name to aid identifying multiple cameras connected to the network. For instance, on an inspection system with 4 cameras, the first camera might be labeled "top view", the second "left view", the third "right view" and the last one "bottom view". The factory default username is set to match the camera serial number for quick initial identification. Note that the factory programmed A68/A38 serial number and MAC address are not user changeable.

When using CamExpert, multiple A68/A38 cameras on the network are seen as different "FLIR\_Ax8\_xxxxx" devices as an example. Non-Teledyne cameras are labeled as "GigEVision Device". Click on a device username to select it for control by CamExpert.

An imaging application uses any one of these attributes to identify a camera: its IP address, MAC address, serial number or User Name. Some important considerations are listed below.

- Do not use the camera's IP address as identification (unless it is a persistent IP) since it can change with each power cycle.
- A MAC address is unique to a single camera, therefore, the control application is limited to the vision system with that unique camera if it uses the camera's MAC address.
- The User Name can be freely programmed to clearly represent the camera usage. This scheme is recommended for an application to identify cameras. In this case, the vision system can be duplicated any number of times with cameras identified by their function, not their serial numbers or MAC address.

# Using CamExpert with A68/A38 Cameras

The Spera CamExpert tool is the interfacing tool for GigE Vision cameras, and is supported by the Spera library and hardware. CamExpert allows a user to test camera functions. Additionally CamExpert saves the A68/A38 user settings configuration to the camera or saves multiple configurations as individual camera parameter files on the host system (\*.ccf).







An important component of CamExpert is its live acquisition display window which allows immediate verification of timing or control parameters without the need to run a separate acquisition program.

## CamExpert Panes

The various areas of the CamExpert tool are described in the summary figure below. GigE Vision device Categories and Parameter features are displayed as per the device's XML description file. The number of parameters shown is dependent on the View mode selected (for example, Beginner, Expert, Guru – see description below).

- **Device pane:** View and select from any installed GigE Vision or Spera acquisition device. After a device is selected CamExpert will only present parameters applicable to that device.
- **Parameters pane:** Allows viewing or changing all acquisition parameters supported by the acquisition device. CamExpert displays parameters only if those parameters are supported by the installed device. This avoids confusion by eliminating parameter choices when they do not apply to the hardware in use.
- **Display pane:** Provides a live or single frame acquisition display. Frame buffer parameters are shown in an information bar above the image window.
- **Control Buttons:** The Display pane includes CamExpert control buttons

Table 16: CamExpert Display Pane Control Buttons

 Grab  Freeze	<b>Acquisition control button:</b> Click once to start live grab, click again to stop.
 Snap	<b>Single frame grab:</b> Click to acquire one frame from device.
 Trigger	<b>Software trigger button:</b> With the I/O control parameters set to Trigger Enabled / Software Trigger type, click to send a single software trigger command.
	<b>CamExpert display controls:</b> (these do not modify the frame buffer data) Stretch (or shrink) image to fit, set image display to original size, or zoom the image to any size and ratio. Note that under certain combinations of image resolution, acquisition frame rate, and host computer speed, the CamExpert screen display may not update completely due to the host CPU running at near 100%. This does not affect the acquisition.
	<b>Histogram / Profile tool:</b> Select to view a histogram or line/column profile during live acquisition.

- **Output pane:** Displays messages from CamExpert or the GigE Vision driver.



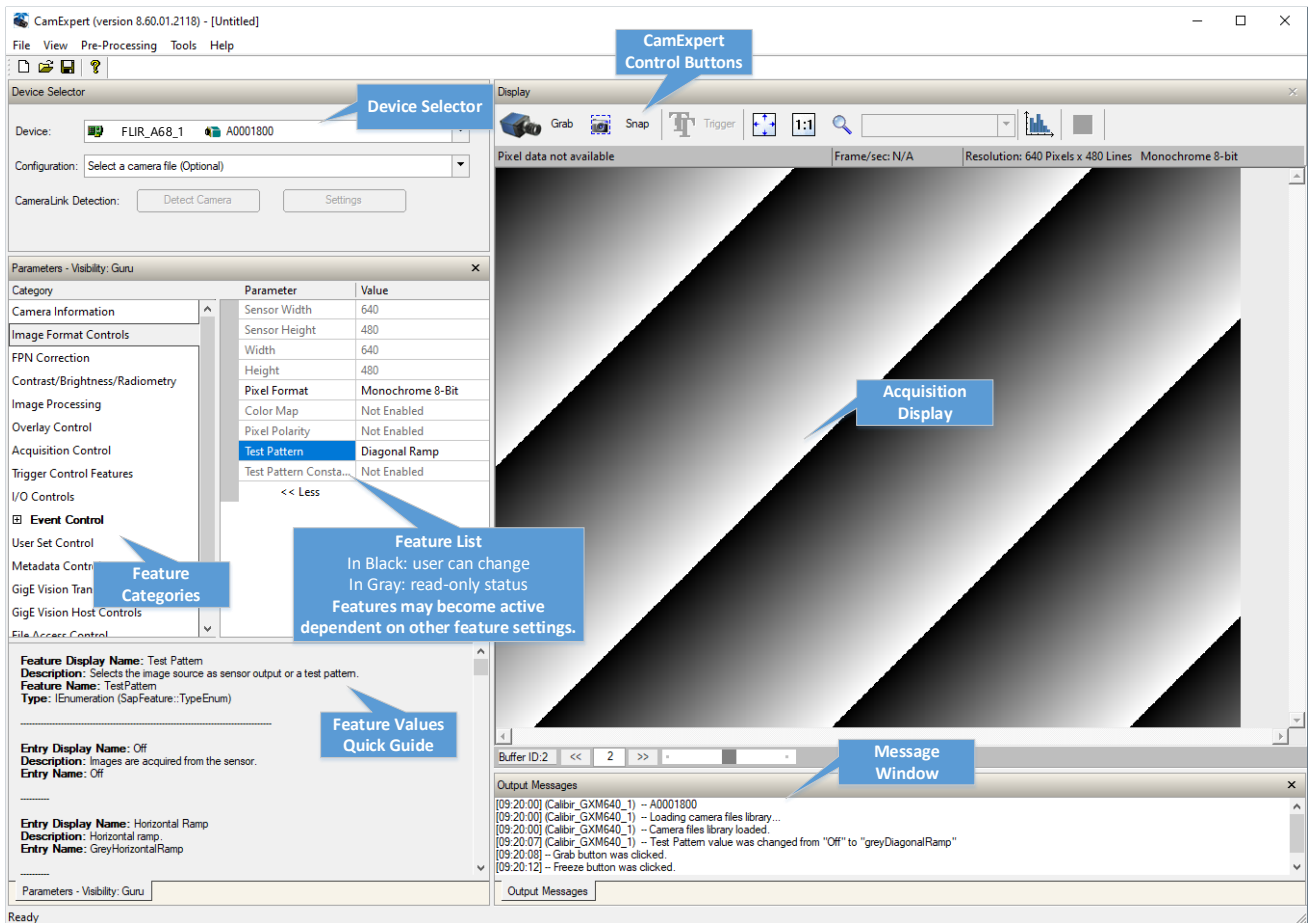

Figure 44: Sapera CamExpert GUI Layout

### ***CamExpert View Parameters Option***

All camera features have a Visibility attribute which defines its requirement or complexity. The states vary from Beginner (features required for basic operation of the device) to Guru (optional features required only for complex operations).

CamExpert presents camera features based on their visibility attribute and provides quick Visibility level selection via controls below each Category Parameter list [ << Less More>> ]. The user can also choose the Visibility level from the *View · Parameters Options* menu.

Parameters in gray are read only, either always or due to other feature settings. Parameters in black are user set in CamExpert or programmable via an imaging application.

Features listed in the description table but tagged as *Invisible* are usually for Teledyne DALSA or third-party software usage—not typically needed by end user applications.

Additionally, the View column indicates which parameter is a member of the DALSA Features Naming Convention (indicated by DFNC), versus the GenICam Standard Features Naming Convention (SFNC tag is not shown). In general, SNFC feature names begin with an uppercase letter, and DFNC features are identified by the use of a lowercase starting letter.

## Camera Information Category

Camera information can be retrieved via a controlling application. Parameters such as camera model, firmware version, and so forth, are read to uniquely identify the connected A68/A38 device. These features are typically read-only. GigE Vision applications retrieve this information to identify the camera along with its characteristics.

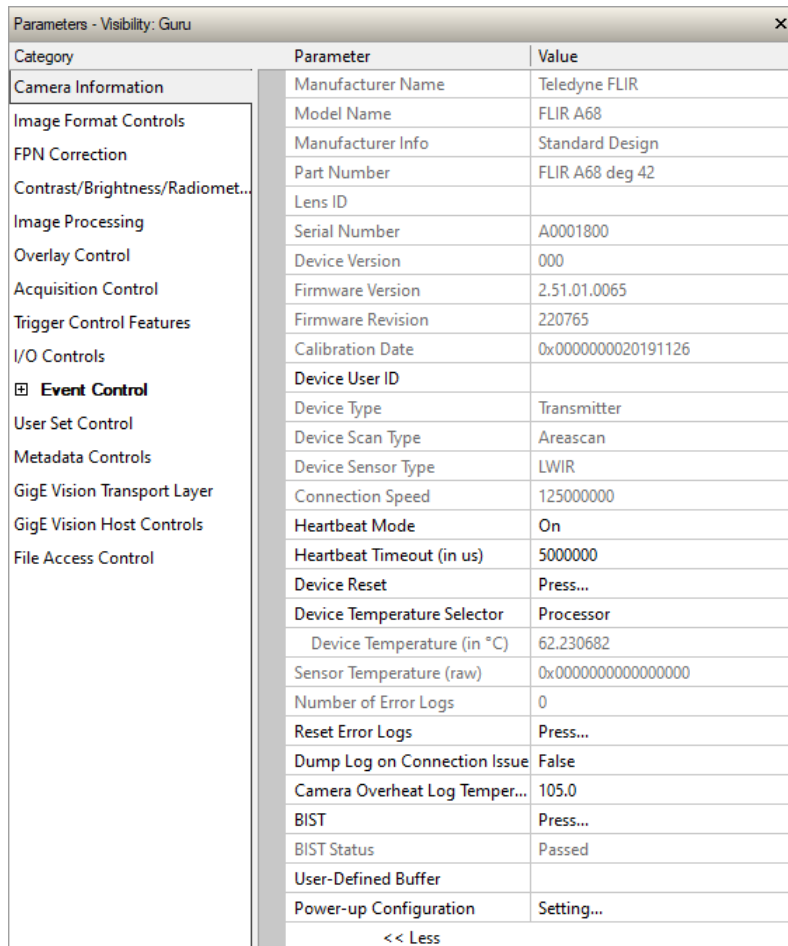

Category	Parameter	Value
Camera Information	Manufacturer Name	Teledyne FLIR
Image Format Controls	Model Name	FLIR A68
FPN Correction	Manufacturer Info	Standard Design
Contrast/Brightness/Radiomet...	Part Number	FLIR A68 deg 42
Image Processing	Lens ID	
Overlay Control	Serial Number	A0001800
Acquisition Control	Device Version	000
Trigger Control Features	Firmware Version	2.51.01.0065
I/O Controls	Firmware Revision	220765
<input checked="" type="checkbox"/> <b>Event Control</b>	Calibration Date	0x0000000020191126
User Set Control	Device User ID	
Metadata Controls	Device Type	Transmitter
GigE Vision Transport Layer	Device Scan Type	Areascan
GigE Vision Host Controls	Device Sensor Type	LWIR
File Access Control	Connection Speed	125000000
	Heartbeat Mode	On
	Heartbeat Timeout (in us)	5000000
	Device Reset	Press...
	Device Temperature Selector	Processor
	Device Temperature (in °C)	62.230682
	Sensor Temperature (raw)	0x0000000000000000
	Number of Error Logs	0
	Reset Error Logs	Press...
	Dump Log on Connection Issue	False
	Camera Overheat Log Temper...	105.0
	BIST	Press...
	BIST Status	Passed
	User-Defined Buffer	
	Power-up Configuration	Setting...

Figure 45: CamExpert Camera Information Category

For more information on the temperature sensors and error log file, refer to the Temperature Sensors and Error Log File sections.

## Camera Information Feature Descriptions

The following table describes these parameters along with their view attribute and in which device version the feature was introduced.

Table 17: Camera Information Feature Descriptions

Display Name	Feature & Values	Description	View
Manufacturer Name	DeviceVendorName	Displays the device vendor name.	Beginner
Model Name	DeviceModelName	Displays the device model name.	Beginner
Family Name	DeviceFamilyName	Displays the identifier of the product family of the camera.	Invisible
Manufacturer Info	DeviceManufacturerInfo	Displays extended manufacturer information about the camera.	Beginner
Part Number	deviceManufacturerPartNumber	Displays the device part number.	Beginner DFNC
Lens ID	lensID	Description of factory-installed lens.	Guru DFNC
Serial Number	DeviceSerialNumber	Displays the device's factory set serial number.	Beginner
Device Version	DeviceVersion	Displays the device version.	Expert
Firmware Version	DeviceFirmwareVersion	Displays the currently loaded firmware version number. Firmware files have a unique number and have the .cbf file extension.	Beginner
Firmware Revision	deviceManufacturerFirmwareNumber	Displays the currently loaded firmware revision.	Guru DFNC
Calibration Date	calibrationDate	Displays the date of factory camera calibration. The date format is 0xYYYYMMDD.	Expert DFNC
Device User ID	DeviceUserID	Feature to store a user-programmable identifier of up to 15 characters. (RW)	Beginner
Device Type	DeviceType	Displays the device type. For FLIR A68/A38 series the device type is Transmitter.	Guru
Device Scan Type	DeviceScanType	Displays the device scan type. For FLIR A68/A38 series the scan type is Areascan.	Expert
Device Sensor Type	deviceSensorType	Displays the sensor type. For FLIR A68/A38 series the sensor type is LWIR (Long Wave Infrared).	Expert DFNC
Connection Speed	DeviceConnectionSpeed	Displays the transmission speed negotiated by the network interface, in bytes per second. For a GigE connection this is 125000000 Bps.	Expert
Heartbeat Mode	DeviceLinkHeartbeatMode	Sets the enable state of heartbeat verification.	Guru
Heartbeat Timeout (in $\mu$ s)	DeviceLinkHeartbeatTimeout	Sets the heartbeat timeout, in microseconds. If heartbeat verification is enabled and the camera does not receive messages from the host application during a certain period, the camera will disconnect to make itself available to other host applications. Applications using Sopera LT to access the camera do not have to manage this explicitly because Sopera LT will maintain the connection.	Guru
Device Reset	DeviceReset	Resets the device to its power up state. (W)	Beginner

Display Name	Feature & Values	Description	View
Device Temperature Selector	DeviceTemperatureSelector	Select the source where the temperature is read.	Beginner
<i>Processor</i>	<i>Processor</i>	Reads the temperature from the processor chip.	
<i>Ethernet PHY</i>	<i>ethernetPhy</i>	Reads the temperature from the ethernet PHY chip.	
<i>Sensor</i>	<i>Sensor</i>	Reads the temperature from the image sensor.	
Device Temperature	DeviceTemperature	The temperature of the selected source in degrees Celsius.	Beginner
Sensor Temperature (raw)	sensorTemperatureRaw	Displays the raw temperature value reported by the sensor. Note that this value does not translate directly to Celsius.	Guru DFNC
Number of Error Logs	crashLogCount	Number of device error files.	Expert DFNC
Reset Error Log	crashLogReset	Resets the error log counter to 0.	Expert DFNC
Dump Log on Connection Issue	crashLogHeartbeat	If enabled, the camera will create an error log (saved in non-volatile memory) when the host computer ceases to keep the camera's heartbeat active. Can be used to debug Ethernet connection issues.	Guru
Camera Overheat Log Temperature	crashLogOverheatTemperature	If the camera's internal temperature goes beyond this value, the camera will create an error log (saved in non-volatile memory).	Expert
User-Defined Buffer	deviceUserBuffer	Defines a 4K byte store register that can hold user-specific data. Camera's user settings must be saved to make the buffer's contents persistent across reboots.	Expert DFNC
BIST	deviceBIST	Triggers a manual Built-In Self Test (BIST) of the device.	Guru DFNC
BIST Status	deviceBISTStatus	Displays the result of the device Built-In Self Test (BIST).	Guru DFNC
<i>Passed</i>	<i>Passed</i>	The device passed the BIST.	
<i>FW Update Failure</i>	<i>FirmwareUpdateFailure</i>	Firmware update failure.	
<i>Firmware Error</i>	<i>FirmwareError</i>	Firmware error.	
<i>Sensor Board Error</i>	<i>SensorBoardError</i>	Sensor board error.	
<i>Memory Test Failed</i>	<i>MemoryTestFailed</i>	Memory test failed.	
<i>Network Loopback Failure</i>	<i>NetworkLoopbackFailure</i>	Network loopback failure.	
<i>Out of Range Temperature</i>	<i>OutOfRangeTemperatureSpecification</i>	Out of range temperature.	
<u>Power-up Configuration Selector</u>	UserSetDefaultSelector	Selects the camera configuration set to load and make active on camera power-up or reset. The camera configuration sets are stored in camera non-volatile memory. For more information, refer to the User Set Control Category.	Beginner
Device Acquisition Type	deviceAcquisitionType	Displays the Device Acquisition Type of the product.	Invisible DFNC
<i>Sensor</i>	<i>Sensor</i>	<i>The device gets its data directly from a sensor.</i>	

Display Name	Feature & Values	Description	View
Device TL Type <i>GigE Vision</i>	DeviceTLType <i>GigEVision</i>	Transport Layer type of the device. <i>GigE Vision Transport Layer</i>	Invisible
Device TL Version Major	DeviceTLVersionMajor	Major version of the device's Transport Layer.	Invisible
Device TL Version Minor	DeviceTLVersionMinor	Minor version of the device's Transport Layer.	
DFNC Major Rev	deviceDFNCVersionMajor	Major revision of Dalsa Feature Naming Convention which was used to create the device's XML.	Invisible
DFNC Minor Rev	deviceDFNCVersionMinor	Minor revision of Dalsa Feature Naming Convention which was used to create the device's XML.	
SFNC Major Rev	DeviceSFNCVersionMajor	Major Version of the Genicam Standard Features Naming Convention which was used to create the device's XML.	Invisible
SFNC Minor Rev	DeviceSFNCVersionMinor	Minor Version of the Genicam Standard Features Naming Convention which was used to create the device's XML.	Invisible
SFNC SubMinor Rev	DeviceSFNCVersionSubMinor	SubMinor Version of the Genicam Standard Features Naming Convention which was used to create the device's XML.	Invisible

## Power-up Configuration Dialog

CamExpert provides a dialog box which combines the features to select the camera power-up state and for the user to save or load a A68/A38 camera state.

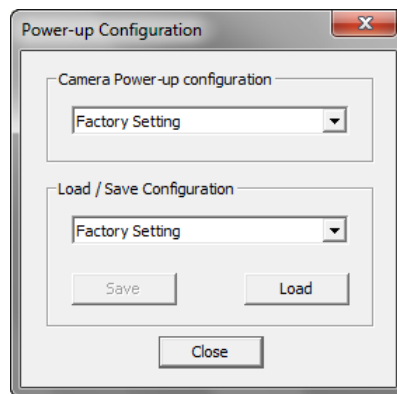

Figure 46: Power-up Configuration Dialog

### Camera Power-up Configuration

The first drop list selects the camera configuration state to load on power-up (see feature *UserSetDefaultSelector*). The user chooses from one factory data set or a user saved set.

### Load / Save Configuration

The second drop list allows the user to change the camera configuration any time after a power-up (see feature *UserSetSelector*). To reset the camera to the factory configuration, select *Factory Setting* and click Load. To save a current camera configuration, select User Settings and click Save. Select User Settings and click Load to restore a saved configuration.

# Image Format Controls Category

The Image Format controls, as shown by CamExpert, groups parameters used to configure camera pixel format, image processing, overlays, and so forth. Additionally, a feature control to select and output an internal test image simplifies qualifying a camera setup.

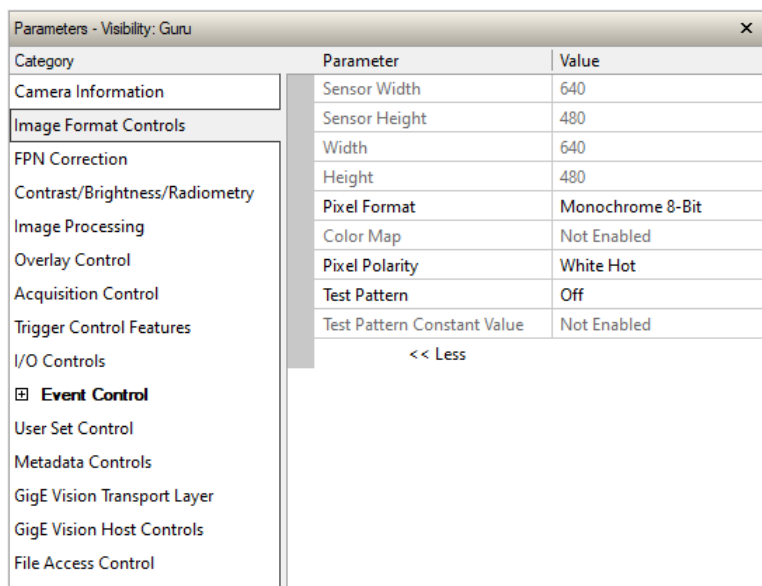

Figure 47: CamExpert Image Format Controls

For more information on pixel polarity, test patterns, and color maps, refer to the Pixel Polarity, Internal Test Pattern Generator, and False Color Mapping sections, respectively.

## Image Format Controls Feature Descriptions

The following table describes these features along with their view attribute.

Table 18: Image Format Controls Feature Descriptions

Display Name	Feature & Values	Description	View
Sensor Width	SensorWidth	Displays the sensor width in active image pixels.	Guru
Sensor Height	SensorHeight	Displays the sensor height in active image pixels.	Guru
Width	Width	Width of the image provided by the device (in pixels).	Beginner
Height	Height	Height of the image provided by the device (in lines).	Beginner
Pixel Format	PixelFormat	Format of the pixel provided by the device. Contains all format information as provided by PixelCoding, PixelSize, PixelColorFilter, combined in one single value.	Beginner
<i>Monochrome 8-Bit</i>	<i>Mono8</i>	Monochrome 8-Bit. This format automatically employs the Contrast Enhancement mechanism to map the 16-bit sensor output to 8-bits.	
<i>Monochrome 16-bit</i>	<i>Mono16</i>	Monochrome 16-Bit. This format uses a 16-bit monochrome buffer format with the most-significant bits (MSB) packed with 00. This format is the calibrated raw output of the sensor.	
<i>YUYV</i>	<i>YUV422_8</i>	YUYV color 16-bit.	

Display Name	Feature & Values	Description	View
Color Map	falseColorMap	Selects the color map to use when using a color output pixel format (such as YUYV). The pixel polarity determines whether high pixel values represent hot or cold objects.	Beginner DFNC
<i>Greyscale</i>	<i>Monochrome</i>	Greyscale (monochrome) output (no color mapping).	
<i>Fire</i>	<i>Fire</i>	Fire color map. The thermal scale from black through violet, red, orange and yellow to white.	
<i>IronBlack</i>	<i>IronBlack</i>	Goes from white to black for low pixel values, then uses Fire color map to highlight high pixel values.	
<i>Custom</i>	<i>Custom</i>	Custom color map. Use the File Access Control mechanism to upload a custom color map to the camera.	
Pixel Polarity	pixelPolarity	Output image pixel polarity. The pixel polarity determines if higher value pixels represent hotter or colder temperatures.	Beginner DFNC
<i>White Cold</i>	<i>WhiteCold</i>	White pixels indicate colder temperatures.	
<i>White Hot</i>	<i>WhiteHot</i>	White pixels indicate hotter temperatures.	
Pixel Size	PixelSize	Reports the total size in bits of an image pixel.	Invisible
<i>8 Bits / Pixel</i>	<i>Bpp8</i>	8 bits per pixel	
<i>16 Bits / Pixel</i>	<i>Bpp16</i>	16 bits per pixel	
<a href="#">Test Pattern</a>	TestPattern	Selects the type of test image generated by the camera.	Beginner
<i>Off</i>	<i>Off</i>	Image is from the camera sensor.	
<i>Horizontal ramp</i>	<i>GreyHorizontalRamp</i>	Image is filled horizontally with an image that goes from the darkest possible value to the brightest.	
<i>Vertical ramp</i>	<i>GreyVerticalRamp</i>	Image is filled vertically with an image that goes from the darkest possible value to the brightest.	
<i>Diagonal ramp</i>	<i>greyDiagonalRamp</i>	Image is filled horizontally with an image that goes from the darkest possible value to the brightest by 1 Dn increment per pixel and per line.	
<i>Uniform, incrementing</i>	<i>purity</i>	Image pixels all have the same value, which increments by 1 for each new image.	
<i>User defined</i>	<i>userDefined</i>	The test pattern is a user-defined image (.bmp format, 640x480, mono8). The user-defined test pattern image is uploaded using the File Access Control features.	
<i>Constant</i>	<i>Constant</i>	Image is filled with a constant value. Use the testPatternConstant feature to set this value.	
Test Pattern Constant	testPatternConstant	When the <a href="#">TestPattern</a> feature is set to Constant, this feature sets the pixel value to fill the image with.	Beginner DFNC
Raw Sensor Output	rawOutputMode	Selects the type of image output.	Guru
<i>Disabled</i>	<i>Disabled</i>	The camera will correct the sensor's non-uniformities and defects. This is the default option.	
<i>Active</i>	<i>Active</i>	Camera will output the sensor's raw uncorrected image. This is an advanced mode; please contact Teledyne's technical support ( <a href="http://www.teledynedalsa.com/mv/support">http://www.teledynedalsa.com/mv/support</a> ) for details.	



# FPN Correction Category

The FPN Correction category, as shown by CamExpert, groups parameters used to configure Fixed Pattern Noise (FPN) compensation.

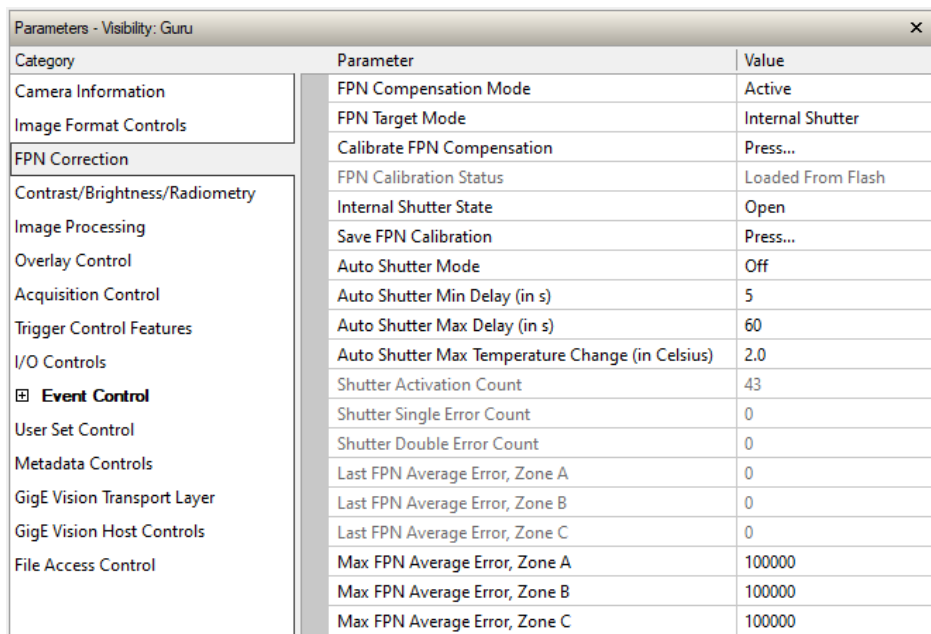

Category	Parameter	Value
Camera Information	FPN Compensation Mode	Active
Image Format Controls	FPN Target Mode	Internal Shutter
FPN Correction	Calibrate FPN Compensation	Press...
Contrast/Brightness/Radiometry	FPN Calibration Status	Loaded From Flash
Image Processing	Internal Shutter State	Open
Overlay Control	Save FPN Calibration	Press...
Acquisition Control	Auto Shutter Mode	Off
Trigger Control Features	Auto Shutter Min Delay (in s)	5
I/O Controls	Auto Shutter Max Delay (in s)	60
<input checked="" type="checkbox"/> <b>Event Control</b>	Auto Shutter Max Temperature Change (in Celsius)	2.0
User Set Control	Shutter Activation Count	43
Metadata Controls	Shutter Single Error Count	0
GigE Vision Transport Layer	Shutter Double Error Count	0
GigE Vision Host Controls	Last FPN Average Error, Zone A	0
File Access Control	Last FPN Average Error, Zone B	0
	Last FPN Average Error, Zone C	0
	Max FPN Average Error, Zone A	100000
	Max FPN Average Error, Zone B	100000
	Max FPN Average Error, Zone C	100000

Figure 48: CamExpert FPN Correction Category

For information on using FPN compensation refer to the Fixed Pattern Noise Correction section.

For more information on the features related to diagnosing internal mechanical shutter problems refer to the Internal Shutter Problems section.

## FPN Correction Feature Descriptions

The following table describes these features along with their view attribute.

Table 19: Image Processing Feature Descriptions

Display Name	Feature & Values	Description	View
FPN Compensation Mode  <i>Off</i> <i>Active</i>	flatfieldCorrectionMode  <i>Off</i> <i>Active</i>	Sets the enable state of the fixed pattern noise (FPN) compensation.  Disables FPN compensation.  Applies the FPN compensation to the image.	Guru DFNC
FPN Target Mode  <i>External Shutter</i>  <i>Internal Shutter</i> <i>Internal Shutter (Advanced)</i>	shutterTarget  <i>External</i>  <i>Internal</i> <i>InternalAdvanced</i>	Selects the shutter target.  The shutter is an external shutter outside the camera body.  Internal camera mechanical shutter.  FPN calibration will use the internal mechanical shutter, but with advanced modelization which provides more uniform images. This option may not be available for cameras that were shipped prior to release 2.41.	Expert DFNC
Calibrate FPN Compensation	flatfieldCalibrationFPN	Calibrates the FPN compensation coefficients. Ideally the camera should be at normal operating temperature. If <i>shutterTarget</i> is set to <i>External</i> , a scene with uniform temperature and reflectivity should be presented to the camera to properly calibrate the FPN compensation. Click "Press" to calibrate.	Beginner DFNC
FPN Calibration Status  <i>Not Calibrated</i>  <i>Loaded From Flash</i>  <i>In Progress</i> <i>Error</i>  <i>Timeout</i>   <i>Success</i>  <i>Success (with shutter retry)</i>   <i>Shutter Problem</i>	flatfieldCalibrationStatus  <i>NotCalibrated</i>  <i>LoadedFromFlash</i>  <i>InProgress</i> <i>Error</i>  <i>Timeout</i>   <i>Success</i>  <i>SuccessWithRetry</i>   <i>ErrorShutterProblem</i>	Reports the status of the last FPN calibration.  FPN calibration has not been calibrated yet.  FPN calibration has been loaded from flash memory at boot.  FPN calibration is in progress.  FPN calibration has failed (cause unknown)  FPN calibration has failed because not enough frames were acquired within a 5 second window. When acquiring in external triggered mode, trigger pulses should be provided to the camera during FPN calibration.  FPN calibration has completed successfully.  FPN calibration ran successfully but the internal shutter had to be retriggered in order to close it completely.  Camera detected that the internal shutter did not close completely prior to FPN calibration.	Expert DFNC

Display Name	Feature & Values	Description	View
<i>Calibration Pending</i>	<i>CalibrationPending</i>	FPN calibration was triggered (either directly through <i>flatfieldCalibrationFPN</i> or by the camera itself through <a href="#">autoShutterMode</a> ). It will be run the next time the acquisition is started or armed.	
<i>Not Enough Memory</i>	<i>NotEnoughMemory</i>	Camera ran out of memory to run the FPN calibration.	
<i>Aborted</i>	<i>Aborted</i>	Acquisition was stopped while FPN calibration was being run.	
Save FPN Calibration	flatfieldCalibrationSave	Saves the FPN calibration coefficients to non-volatile camera memory. Click "Press" to save.	Beginner DFNC
Auto Shutter Mode	autoShutterMode	Selects the criteria used to automatically trigger FPN recalibration. When this feature is activated it is preferable to configure <i>shutterTarget</i> to use the camera's internal shutter.	Beginner DFNC
<i>Off</i>	<i>Disabled</i>	Disables auto shutter: The camera will never trigger an FPN calibration on its own.	
<i>Temperature Diff</i>	<i>Temperature</i>	FPN will be automatically recalibrated if the camera's internal temperature drifts more than a certain threshold since the last FPN calibration. The threshold is configured using <a href="#">autoShutterMaxTempDiff</a> .	
<i>Time Diff</i>	<i>Time</i>	FPN will be automatically recalibrated if a certain time (configured by <a href="#">autoShutterMaxDelay</a> ) has elapsed since last FPN recalibration.	
<i>Temperature or Time Diff</i>	<i>TemperatureTime</i>	FPN recalibration will be triggered if either the temperature or time criteria is exceeded.	
Auto Shutter Min Delay (in s)	autoShutterMinDelay	Sets the minimum time between two automatic FPN recalibrations.	Beginner DFNC
Auto Shutter Max Delay (in s)	autoShutterMaxDelay	Sets the maximum time between automatic FPN recalibrations. Used when <i>autoShutterMode</i> is either <i>Time</i> or <i>TemperatureTime</i> .	Beginner DFNC
Auto Shutter Max Temperature (in Celsius)	autoShutterMaxTempDiff	Sets the camera temperature difference, in degrees Celsius, that will trigger automatic FPN recalibration.	Beginner DFNC
Internal Shutter State	shutterState	Specifies the current shutter state.	Beginner DFNC
<i>Open</i>	<i>Open</i>	Shutter is open.	
<i>Closed</i>	<i>Closed</i>	Shutter is closed.	
Shutter Single Error Count	shutterErrorCountSingle	Number of times the internal shutter failed a single time during FPN calibration. Camera is able to compensate for single error but reopening and reclosing the internal shutter (if it fails again though it's counted as a double error).	Guru DFNC

Display Name	Feature & Values	Description	View
Shutter Double Error Count	shutterErrorCountDouble	Number of times the internal shutter failed twice during FPN calibration. FPN calibration is considered failed when this happens.	Guru DFNC
Last FPN Average Error, Zone A	shutterErrorZoneA	Average pixel value error found for Zone A (whole image) when internal shutter was closed for FPN calibration.	Guru DFNC
Last FPN Average Error, Zone B	shutterErrorZoneB	Average pixel value error found for Zone B (left of image) when internal shutter was closed for FPN calibration.	Guru DFNC
Last FPN Average Error, Zone C	shutterErrorZoneC	Average pixel value error found for Zone C (bottom of image) when internal shutter was closed for FPN calibration.	Guru DFNC
Max FPN Average Error, Zone A	shutterErrorThresholdZoneA	Maximum average pixel value error that can be corrected for Zone A (whole image). If the average pixel value error is greater than this threshold the camera assumes that the internal shutter could not be closed correctly and tries to close the shutter again (once).	Guru DFNC
Max FPN Average Error, Zone B	shutterErrorThresholdZoneB	Maximum average pixel value error that can be corrected for Zone B (left of image). If the average pixel value error is greater than this threshold the camera assumes that the internal shutter could not be closed correctly and tries to close the shutter again (once).	Guru DFNC
Max FPN Average Error, Zone C	shutterErrorThresholdZoneC	Maximum average pixel value error that can be corrected for Zone C (bottom of image). If the average pixel value error is greater than this threshold the camera assumes that the internal shutter could not be closed correctly and tries to close the shutter again (once).	Guru DFNC
Recalibrate Supplemental FPN Correction	supplementalFPNCalibrate	<a href="#">Calibrate the camera's internal shutter correction</a> in order to obtain a flat image after adjusting the FPN compensation using the internal shutter. A uniform surface should be placed in front of the camera for the duration of the calibration. Camera must already be acquiring images before the calibration can be started.	Guru
Save Supplemental FPN Correction	supplementalFPNSave	Save the supplemental FPN correction table to non-volatile memory.	Guru

# Contrast / Brightness / Radiometry Category

The Contrast / Brightness category, as shown by CamExpert, groups parameters used to configure the image contrast enhancement features when displaying 8-bit images.

Category	Parameter	Value
Camera Information	Contrast Mode	Fixed Adaptive
Image Format Controls	Contrast	200
FPN Correction	Brightness	128
Contrast/Brightness/Radiomet...	Contrast Zone Left X	0
Image Processing	Contrast Zone Right X	639
Overlay Control	Contrast Zone Top Y	0
Acquisition Control	Contrast Zone Bottom Y	479
Trigger Control Features	Max Gain Enable	Not Enabled
I/O Controls	Max Gain Value	Not Enabled
<input checked="" type="checkbox"/> Event Control	Min Input Value (in DN)	0
User Set Control	Max Input Value (in DN)	16383
Metadata Controls	Min Input Temperature (in °C)	Not Enabled
GigE Vision Transport Layer	Max Input Temperature (in °C)	Not Enabled
GigE Vision Host Controls	Radiometry Gain (Responsivity) (in DN per °C)	100
File Access Control	Radiometry Gain Correction	1.0
	Radiometry Offset (DN16 at 0 Celsius)	30000
	Radiometry Offset Correction Mode	Off
	Radiometry Offset Correction (in °C)	0.0
	Zone Selector	Zone 1
	X1	0
	X2	639
	Y1	0
	Y2	479
	Reference Zone Temperature (in °C)	0.0

Figure 49: CamExpert Contrast / Brightness/ Radiometry Category

For information on using the contrast and brightness features, refer to the Contrast Enhancement section.

## Contrast / Brightness / Radiometry Feature Descriptions

The following table describes these features along with their view attribute.

Table 20: Contrast / Brightness /Radiometry Feature Descriptions

Display Name	Feature & Values	Description	View
Contrast Mode	contrastMode	Determines how images are remapped from 16-bits to 8-bits.	Beginner DFNC
<i>Dynamic Adaptive</i>	<i>AdaptiveDynamic</i>	Remapping depends on the <i>contrast</i> feature setting. The algorithm will attempt to provide a well contrasted image by adapting to the dynamic range of the scene.	
<i>Static (DN)</i>	<i>Static</i>	Remapping depends on the <i>contrastMinValue</i> and <i>contrastMaxValue</i> feature settings.	
<i>Fixed Adaptive</i>	<i>AdaptiveFixed</i>	Remapping depends on the camera temperature and the <i>contrast</i> and <a href="#">brightness</a> features settings.	

Display Name	Feature & Values	Description	View
<i>Static (Temperature)</i>	<i>StaticTemperature</i>	Remapping depends on the <i>contrastMinValueCelsius</i> and <i>contrastMaxValueCelsius</i> feature settings. Features <i>contrastMinValue</i> and <i>contrastMaxValue</i> will be updated to reflect the DN values (in the source 16-bit image) that get remapped to the 0-255 output range of the 8-bit image.	
Contrast	contrast	When the output pixel format is 8-bits, the contrast setting determines the range of values in the 16-bit image that are mapped to 8-bit output. The higher the contrast, the more the values are stretched across the 8-bit range. When contrast is set to the maximum value (255), the image is effectively almost binarized.	Beginner DFNC
Brightness	brightness	Sets the brightness value. A brightness setting greater than 128 make the image lighter (shifts pixel values up); lower than 128 makes the image darker (shifts pixel values down). This feature is only available when the Contrast Mode ( <i>contrastMode</i> ) feature is set to Fixed Adaptive ( <i>AdaptiveFixed</i> ).	Beginner DFNC
Contrast zone x1	contrastZoneX1	Horizontal coordinate of the top-left corner of the contrast zone. The contrast zone is the rectangular portion of the image for which contrast is optimized by the camera, for <i>AdaptiveDynamic</i> and <i>AdaptiveFixed</i> contrast modes.	Expert DFNC
Contrast zone x2	contrastZoneX2	Horizontal coordinate of the bottom-right corner of the contrast zone.	Expert DFNC
Contrast zone y1	contrastZoneY1	Vertical coordinate of the top-left corner of the contrast zone.	Expert DFNC
Contrast zone y2	contrastZoneY2	Vertical coordinate of the bottom-right corner of the contrast zone.	Expert DFNC
Maximum Gain Enable	contrastMaxGainEnable	Sets the enable state of the gain limit feature. When enabled, and the scene contains very little contrast, the amount of contrast stretching applied to the input image is limited by the maximum gain. This reduces noise amplification. This feature is available when the Contrast Mode ( <i>contrastMode</i> ) is set to Dynamic Adaptive ( <i>AdaptiveDynamic</i> ).	Beginner DFNC
Maximum Gain Value	contrastMaxGainValue	Sets the maximum gain to use for contrast stretching the input image. Higher values result in more contrast stretching. This feature is only available when the Maximum Gain ( <i>contrastMaxGainEnable</i> ) feature is enabled.	Beginner DFNC
Minimum Input Value	contrastMinValue	Sets the minimum input 16-bit pixel value when the Contrast Mode ( <a href="#">contrastMode</a> ) is set to Fixed Adaptive ( <i>AdaptiveFixed</i> ).	Beginner DFNC
Maximum Input Value	contrastMaxValue	Maximum input value for static contrast	Beginner DFNC
Minimum Input Temperature	contrastMinValueCelsius	Sets the lower temperature (in degrees Celsius), that gets mapped to 0-255 range of the output 8-bits image.	Beginner

Display Name	Feature & Values	Description	View
Maximum Input Temperature	contrastMaxValueCelsius	Sets the upper temperature (in degrees Celsius), that gets mapped to 0-255 range of the output 8-bits image.	Beginner
Radiometry Gain (Responsivity) (in DN per °C)	radiometryGain	Sets the slope of the pixel response, in DN per degree Celsius. Lower value means less precision but allows wider range of scene temperature.	Beginner DFNC
Radiometry Gain Correction	radiometryGainCorrection	Configures a user-defined multiplicative gain to correct the slope of the pixels response.	Guru DFNC
Radiometry Offset (DN16 at 0 Celsius)	radiometryOffset	Sets the pixel value (16-bits, before optional conversion to 8-bits) that corresponds to 0 degree Celsius.	Beginner DFNC
Radiometry Offset Correction Mode	radiometryOffsetCorrectionMode	Determines if and how a constant offset is added to every pixel value to correct radiometric measurements.	Guru DFNC
<i>Off</i>	<i>Off</i>	Factory radiometric calibration is applied without correction.	
<i>Manual</i>	<i>Manual</i>	Correction is manually set by the value of <a href="#">radiometryOffsetCorrection</a> .	
<i>Reference = Contrast Zone</i>	<i>ReferenceContrast Zone</i>	Offset correction is computed by assuming that the contrast zone's average temperature has a certain value set by <a href="#">radiometryOffsetCorrectionReference</a> .	
<i>Reference = Zone 1</i>	<i>ReferenceZone 1</i>	Offset correction is computed by assuming that the average temperature of Zone 1 has a certain value set by <a href="#">radiometryOffsetCorrectionReference</a> .	
<i>Reference = Zone 2</i>	<i>ReferenceZone 2</i>	Offset correction is computed by assuming that the average temperature of Zone 2 has a certain value set by <a href="#">radiometryOffsetCorrectionReference</a> .	
Radiometry Offset Correction (in °C)	radiometryOffsetCorrection	Offset (in °C) that gets added to every pixel value to correct radiometric measurements.	Guru DFNC
Zone Selector	zoneSelector	Selects the Zone to configure.	Beginner DFNC
<i>Zone 1</i>	<i>Zone1</i>	Configure Zone 1.	
<i>Zone 2</i>	<i>Zone2</i>	Configure Zone 2.	
Zone X1	zoneX1	X coordinate (horizontal, from left) of the top-left corner of the selected Zone.	Beginner DFNC
Zone Y1	zoneY1	Y coordinate (vertical, from top) of the top-left corner of the selected Zone.	Beginner DFNC
Zone X2	zoneX2	X coordinate (horizontal, from left) of the bottom-right corner of the selected Zone.	Beginner DFNC
Zone Y2	zoneY2	Y coordinate (vertical, from top) of the bottom-right corner of the selected Zone.	Beginner DFNC
Reference Zone Temperature (in °C)	radiometryOffsetCorrectionReference	Expected temperature (in °C) of the selected zone.	Guru

## Image Processing Category

The Image Processing category, as shown by CamExpert, groups parameters used to configure defective pixel map replacement, noise, column and median filters, as well as zoom factors.

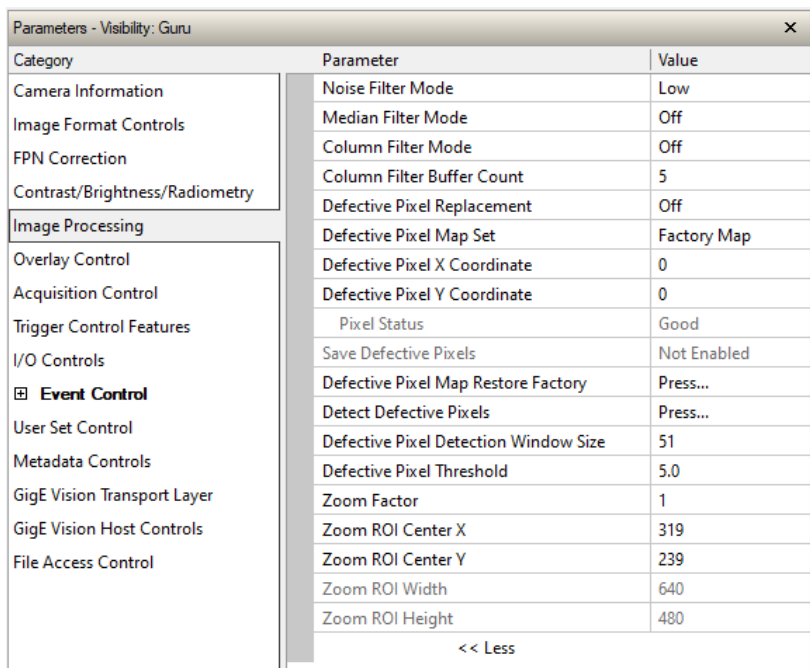

Figure 50: CamExpert Image Processing Category

For more information on using defective pixel maps and the median filter, refer to the Defective Pixel Correction and Median Filter sections, respectively.

## Image Processing Feature Descriptions

The following table describes these features along with their view attribute.

Table 21: Image Processing Feature Descriptions

Display Name	Feature & Values	Description	View
Noise Filter Mode	noiseFilterMode	Sets how the camera filters out noise from the image.	Beginner DFNC
<i>Low</i>	<i>Low</i>	Filtering is activated but its effect is kept minimal. Few artifacts should be seen in the image.	
<i>Medium</i>	<i>Medium</i>	Enables noise filtering. Some artifacts may be visible when the camera scene changes rapidly.	
<i>High</i>	<i>High</i>	Enables noise filtering. Artifacts will be visible when the camera scene changes rapidly.	
Median Filter Mode	medianFilterMode	Applies a median filter (non-linear smoothing operation) using a 3x3 kernel to the image, which reduces noise artifacts.	Beginner DFNC
<i>Off</i>	<i>Off</i>	Disables median filter.	
<i>Full</i>	<i>Full</i>	Applies the median filter to every pixel in the image.	
<i>Selective</i>	<i>Selective</i>	Applies median filter to the worst pixels only.	



Display Name	Feature & Values	Description	View
Column Filter Mode	columnFilterMode	Applies an algorithm that detects if a given column is consistently brighter or darker than its neighbors and attempts to correct this by adding an offset to the value of every pixel in this column. When set to Active, an artifact may appear if a well focused object remains for a long time in the scene.	Beginner DFNC
<i>Off</i>	<i>Off</i>	Disables the column filter.	
<i>Active</i>	<i>Active</i>	Activates the column filter.	
Column Filter Buffer Count	columnFilterBufferCount	Determines the number of recent images used for the column filter. A higher value will make the algorithm more robust to the presence of hot/narrow objects moving in the image.	Guru DFNC
Defective Pixel Replacement	defectivePixelReplacementMode	Sets the enable state of defective pixel replacement.	Beginner DFNC
<i>Off</i>	<i>Off</i>	Disables defective pixel replacement.	
<i>Active</i>	<i>Active</i>	Enables defective pixel replacement. Defective pixels are replaced with the average value of the neighboring valid pixels.	
Defective Pixel Map Set	defectivePixelReplacementMapCurrentActiveSet	Selects the map that identifies the defective pixels.	Expert DFNC
<i>User Map 1</i>	<i>userMap1</i>	User-defined defective pixel map.	
<i>Factory</i>	<i>factoryMap</i>	Factory calibrated defective pixel map.	
Defective Pixel X Coordinate	defectivePixelXCoordinate	Specifies the X coordinate of the pixel in the defective pixel map for which to verify or change the status.	Guru DFNC
Defective Pixel Y Coordinate	defectivePixelYCoordinate	Specifies the Y coordinate of the pixel in the defective pixel map for which to verify or change the status.	Guru DFNC
Pixel Status	defectivePixelStatus	Displays the current status of the specified pixel in the defective pixel map.	Guru DFNC
Save Defective Pixels	defectivePixelSaveMap	Commit user-defined defective pixel to non-volatile memory.  To enable this feature, set the Defective Pixel Map Set ( <i>defectivePixelReplacementMapCurrentActiveSet</i> ) must to <i>userMap1</i> .	Expert DFNC
Defective Pixel Map Restore Factory	defectivePixelRestoreFactoryMap	Copies the factory defective map to the user-defined defective pixel map.	Guru DFNC
Detect Defective Pixels	defectivePixelDetectionTrigger	Starts the automatic bad pixel detection sequence. This may take several minutes depending on the size of the detection window.	Guru DFNC
Defective Pixel Detection Window Size	defectivePixelDetectionWindowSize	Sets the height/width of the square neighborhood, in pixels, for automatic bad pixel detection. The bigger the number the slower the sequence. Default is 51 (51 x 51 neighborhood).	Guru DFNC

Display Name	Feature & Values	Description	View
Defective Pixels Threshold	defectivePixelDetectionResponseThreshold	Sets the threshold, as the number of standard deviations from the neighborhood average, for a pixel to be considered defective.	Guru DFNC
Zoom Factor	zoomFactor	Takes a Region of Interest in the source image and scales it up to occupy the whole image.  Zoom factor is always a power of 2; possible values are 1,2,4,8,16.	Beginner DFNC
Zoom ROI Center X	zoomROICenterX	X coordinate (horizontal, from left) of the center of the zoom ROI.	Beginner DFNC
Zoom ROI Center Y	zoomROICenterY	Y coordinate (vertical, from top) of the center of the zoom ROI.	Beginner DFNC
Zoom ROI Width	zoomROIWidth	Displays the current ROI width, in pixels.	Beginner DFNC
Zoom ROI Height	zoomROIHeight	Displays the current ROI height, in pixels.	Beginner DFNC

# Overlay Control Category

The Overlay Control category, as shown by CamExpert, groups parameters used to enable and configure a graphic overlay in the output image. Each overlay can be individually set active allowing multiple overlays at the same time.

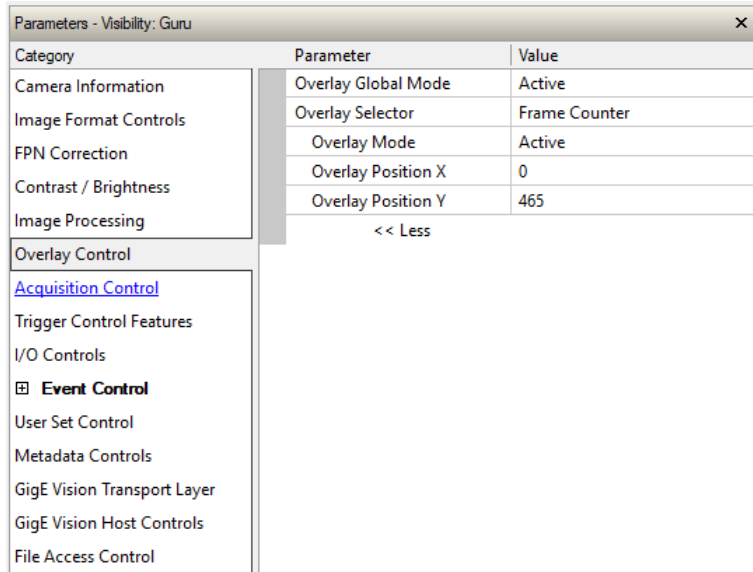

Figure 51: CamExpert Overlay Category

For more information on using overlays, refer to the [Overlays](#) section.

## Overlay Feature Descriptions

The following table describes these parameters along with their view attribute.

Table 22: Overlay Feature Descriptions

Display Name	Feature & Values	Description	View
Overlay Global Mode	overlayGlobalMode	Sets the enable state of the display of overlays. This globally enables/disables the display of all currently enabled overlays in the image.	Beginner DFNC
<i>Off</i>	<i>Off</i>	Disable overlay display.	
<i>Active</i>	<i>Active</i>	Enable display of overlays.	
Overlay Selector	overlaySelector	Selects the graphic overlay for which to modify settings.	Beginner DFNC
<i>Reticle</i>	<i>GraphReticle</i>	Reticle (crosshair) graphic overlay. By default, the reticle position is in the center of the image (320, 240).	
<i>Colormap</i>	<i>GraphColorMap</i>	Displays the range of possible pixel colors in the image as a rectangular graphic (10 pixels high), increasing intensity from left to right. By default, the color map position in the bottom right (370, 470).	
<i>Frame Counter</i>	<i>TextFrameCount</i>	Frame counter graphic overlay. By default, the frame counter position is in the bottom left corner (0, 465).	
<i>Alarm Status</i>	<i>AlarmStatus</i>	Pixels in image will contain the status of the alarms	
<i>Metadata</i>	<i>MetaOverlay</i>	The metadata associated to the frame will be drawn into the image. Can be useful when using a 3 <sup>rd</sup> party GigE Vision implementation that doesn't support metadata. By default, the metadata overlay position is the top-left corner (0,0).	

Display Name	Feature & Values	Description	View
Zone 1	Zone1	Highlights the corners of Zone 1 in the image, as configured by the features <i>zoneX1</i> , <i>zoneX2</i> , <i>zoneY1</i> and <i>zoneY2</i> ( <a href="#">zoneSelector</a> must first be set to <i>Zone1</i> ).	
Zone 2	Zone2	Highlights the corners of Zone 2 in the image, as configured by the features <i>zoneX1</i> , <i>zoneX2</i> , <i>zoneY1</i> and <i>zoneY2</i> ( <a href="#">zoneSelector</a> must first be set to <i>Zone2</i> ).	
Overlay Mode	overlayMode	Sets the enable state of the selected graphic overlay.	Beginner DFNC
Off	Off	Disable selected overlay.	
Active	Active	Enable selected overlay.	
Overlay position X	overlayPositionX	Sets the horizontal position of the top-left corner of the selected graphic overlay in the image. When <a href="#">overlaySelector</a> is set to <i>Zone1</i> or <i>Zone2</i> , the position of the overlay is set by the selected zone's <a href="#">zoneX1</a> , <a href="#">zoneX2</a> values.	Beginner DFNC
Overlay position Y	overlayPositionY	Sets the vertical position of the top-left corner of the selected graphic overlay in the image. When <a href="#">overlaySelector</a> is set to <i>Zone1</i> or <i>Zone2</i> , the position of the overlay is set by the selected zone's <a href="#">zoneY1</a> , <a href="#">zoneY2</a> values.	Beginner DFNC

## Acquisition Control Category

The Acquisition Control category, as shown by CamExpert, has parameters used to configure the optional acquisition modes of the device.

The screenshot shows a window titled "Parameters - Visibility: Guru" with a tree view on the left and a table of parameters on the right. The "Acquisition Control" category is selected in the tree view. The table lists the following parameters and their values:

Category	Parameter	Value
Camera Information	Acquisition Mode	Not Enabled
Image Format Controls	Acquisition Arm	Press...
FPN Correction	Acquisition Arm Status	Not Armed
Contrast / Brightness	Acquisition Start	Not Enabled
Image Processing	Acquisition Stop	Not Enabled
Overlay Control	Acquisition Frame Count	Not Enabled
Acquisition Control	Frame Rate (in Hz)	0.0
Trigger Control Features	Transfer Frame Skip	0
I/O Controls	Acquisition Status Selector	Acquisition Active
Event Control	Acquisition status	False
User Set Control	<< Less	
Metadata Controls		
GigE Vision Transport Layer		
GigE Vision Host Controls		
File Access Control		

Figure 52: CamExpert Acquisition Control

## Acquisition Control Feature Descriptions

The following table describes these parameters along with their view attribute. Note that when using the Sapera LT API to control a camera, most of these features (exception made for *AcquisitionArm* and *transferFrameSkip*) are handled by Sapera LT's *SapTransfer* object).

Table 23: Acquisition Control Feature Descriptions

Display Name	Feature & Values	Description	View
Acquisition Mode	AcquisitionMode	Set the acquisition mode of the device. It defines the number of frames to capture during an acquisition and the way the acquisition stops.	Beginner
Acquisition Start	AcquisitionStart	Start image capture using the currently selected acquisition mode. The number of frames captured is specified by AcquisitionMode feature.	Beginner
Acquisition Arm	AcquisitionArm	Arms the device before an AcquisitionStart command. This optional command validates all the current features for consistency and prepares the device for a fast start of the acquisition. If not used explicitly, this command is automatically executed at the first AcquisitionStart but will not be repeated for subsequent ones unless a data transfer related feature is changed in the device.	Guru
Acquisition Stop	AcquisitionStop	Stops the Acquisition of the device at the end of the current frame unless the triggerFrameCount feature is greater than 1.	Beginner
Acquisition Frame Count	AcquisitionFrameCount	Number of frames to be acquired in MultiFrame acquisition mode.	Beginner
Frame Rate (in Hz)	AcquisitionFrameRate	Returns the camera internal frame rate.	Beginner

Frame Skip	transferFrameSkip	Sets the number of frames skipped for every frame that is transferred. Skip $n$ results in a frame rate of $30.0/(n + 1)$ .	Beginner DFNC
Acquisition Status Selector	AcquisitionStatusSelector	Selects the internal acquisition signal to read using the <i>AcquisitionStatus</i> feature.	Expert
<i>Trigger Wait</i>	<i>AcquisitionTriggerWait</i>	Device is currently waiting for a trigger for the capture of one or many frames.	
<i>Acquisition Active</i>	<i>AcquisitionActive</i>	Device is currently acquiring one or many frames.	
<i>Acquisition Transfer</i>	<i>AcquisitionTransfer</i>	Device is currently transferring one or many acquired frames.	
<i>Frame Trigger Wait</i>	<i>FrameTriggerWait</i>	Device is currently waiting for a frame start trigger.	
<i>Frame Active</i>	<i>FrameActive</i>	Device is currently acquiring a frame.	
Acquisition Status	AcquisitionStatus	Reads the state of the internal acquisition signal selected using the Acquisition Status Selector feature. (i.e. <i>False</i> / <i>True</i> )	Expert
Continuous Transfer Mode	continuousTransferMode	Configures the camera output.	Guru
<i>Off</i>	<i>Off</i>	The camera will only output valid images. There may be a gap during the transfer of images, e.g. when the camera performs an automatic FPN calibration.	
<i>Active</i>	<i>Active</i>	The camera will always output an image whenever an image has been acquired from the sensor. When an image would normally have been dropped, the camera will output a blank image and the first bytes will spell 'INVALID'.	

### ***Acquisition Buffering***

All acquisitions are internally buffered and transferred as fast as possible to the host system. This internal buffer allows uninterrupted acquisitions no matter of any transfer delays that might occur (such as acquisition frame rates faster than the Gigabit Ethernet link or the [IEEE Pause frame](#)). Only when the internal buffer is consumed would an Image Lost Event be generated (currently this is reported in the frame's metadata only, see the [Metadata section](#)).

## Features that Cannot be Changed During a Transfer

The following features cannot be changed during an acquisition or when a transfer is connected.

Feature Group	Features Locked During a Sopera Transfer
<a href="#">CAMERA INFORMATION</a>	UserSetLoad UserSetSave UserSetDefault UserSetDefaultSelector crashLogReset deviceBIST
<a href="#">FPN CORRECTION</a>	flatfieldCorrectionMode flatfieldCalibrationSave
<a href="#">CONTRAST / BRIGHTNESS</a>	contrastMode
<a href="#">IMAGE PROCESSING</a>	noiseFilterMode defectivePixelReplacementMode defectivePixelReplacementMapCurrentActiveSet defectivePixelXCoordinate defectivePixelYCoordinate defectivePixelSaveMap defectivePixelRestoreFactoryMap defectivePixelDetectionTrigger defectivePixelDetectionWindowSize defectivePixelDetectionResponseThreshold
<a href="#">ACQUISITION CONTROL</a>	AcquisitionMode AcquisitionArm
<a href="#">TRIGGER CONTROL</a>	TriggerMode TriggerSource
<a href="#">IMAGE FORMAT CONTROL</a>	PixelFormat falseColorMap TestPattern
<a href="#">GIGE VISION TRANSPORT LAYER CONTROL</a>	GevIPConfiguration GevMCPHostPort GevMCTT GevMCRC GevSCPHostPort GevSCPSFireTestPacket GevSCPSDoNotFragment GevSCSPPacketSize GevSCDA
<a href="#">GIGE VISION HOST CONTROL</a>	InterPacketTimeout InterPacketTimeoutRaw ImageTimeout
<a href="#">FILE ACCESS CONTROL</a>	NA

## Trigger Control Features Category

The Trigger Control Features category, as shown by CamExpert, groups features used to configure an external trigger input for acquisition. For more information on using an external trigger input, see the External Trigger and 10-pin I/O Connector Details sections.

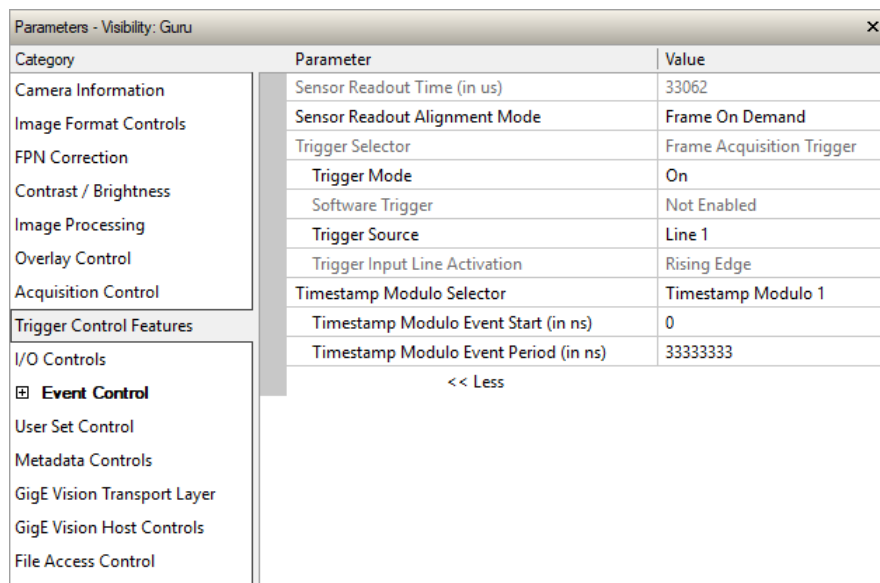

Figure 53: CamExpert Trigger Control Features Category

## Trigger Controls Feature Descriptions

The following table describes these parameters along with their view attribute.

Table 24: Trigger Control Controls Feature Descriptions

Display Name	Feature & Values	Description	View
Sensor Readout Time (in $\mu$ s)	readoutTime	Time taken by camera to readout a frame from the sensor. The readout time is factory calibrated. The readout time / number of image lines provides the acquisition delay between lines. (RO)	Beginner DFNC
Sensor Readout Alignment Mode	readoutAlignment	Determines if the sensor outputs frames on request or is free-running. Typically, microbolometers sensors provide better image quality when free-running.  Microbolometer sensor is continuously acquiring images. This ensures the most stable operating temperature conditions and provides better image quality. When <a href="#">TriggerMode</a> is On, upon reception of a trigger event the next frame will be output. This gives a frame latency up to one frame (33.3 ms).  When <a href="#">TriggerMode</a> is On, the microbolometer will output images only upon detection of a valid trigger event. This gives a deterministic frame latency and is useful when synchronizing multiple cameras. Image quality will be best when the triggers occur at a stable frequency.	Beginner DFNC
Free Running	FreeRunning		
Frame On Demand	FrameOnDemand		
Trigger Selector	TriggerSelector	Selects which type of trigger to configure with the various Trigger features.	Beginner
Frame Acquisition Trigger	AcquisitionStart	Enables the selection of a trigger source that starts the Acquisition of frame.	



Display Name	Feature & Values	Description	View
Trigger Mode  <i>Off</i>  <i>External trigger</i>	TriggerMode  <i>Off</i>  <i>On</i>	Controls the enable state of the selected trigger.  The selected trigger is turned off. Camera acquires at its nominal internal frame rate (30 fps) and outputs all images.  The selected trigger is turned active.	Beginner
Software Trigger	TriggerSoftware	Generate a software command internal trigger immediately. This feature is available only when <a href="#">TriggerSource</a> is set to Software.	Beginner
Trigger Source  <i>Line 1</i>  <i>Timestamp Modulo Event 1</i>  <i>Timestamp Modulo Event 2</i>  <i>Software</i>	TriggerSource  <i>Line1</i>  <i>timestampModuloEvent1</i>  <i>timestampModuloEvent2</i>  <i>Software</i>	Specifies the internal signal or physical input line to use as the trigger source. The selected trigger must have its TriggerMode set to On. See 10-pin I/O Connector Details for more information.  Selects Line 1 to use as the external trigger source. See LineSelector feature for complete list.  Selects the Timestamp Modulo Event 1 as the internal trigger source. This can be used to synchronize multiple cameras (when enabling PTP) or reduce the frame rate from its nominal value of 30 fps.  Selects the Timestamp Modulo Event 2 as the internal trigger source.  Selects a software event as the trigger source (those are generated when the host application writes to TriggerSoftware)	Beginner   DFNC  DFNC
Trigger Input Line Activation  <i>Rising Edge</i>	TriggerActivation  <i>RisingEdge</i>	Selects the activation mode for the selected Input Line trigger source. This is applicable only for external line inputs.  The trigger is considered valid on the rising edge of the line source signal.	Beginner
Timestamp Modulo Selector	timestampModuloSelector	Selects the timestamp modulo.	Expert DFNC
Timestamp Modulo Start Time	timestampModuloStartTime	Specifies the timestamp value that must be exceeded by the incrementing timestamp counter before the modulo events start. This Feature is also used for a "Future" Frame Acquisition.	Expert DFNC
Timestamp Modulo Event Period	timestampModulo	Specifies the interval (in nanoseconds) between Timestamp Modulo Events.	Expert DFNC

## Examples using Timestamp Modulo Event for Acquisitions

The Timestamp Modulo event is used to automate repetitive acquisitions based on the camera's internal Timestamp counter (which can optionally be synchronized to other devices through the PTP protocol)

The Timestamp counter increments continuously but can be reset to zero by writing to the *TimestampReset* feature.

### Case Examples Overview

The following case examples use a simplified Timestamp timeline, which for clarity is shown with time tics from 00 to 60 without units. A timeline scale based on real time is not required to describe the usage concepts.

#### Case 1: Simple Repeating Acquisitions as Upcoming Events

##### Conditions:

- initial *TimestampReset* resets Timestamp counter
- [\*timestampModuloStartTime\*](#) = 20
- *timestampModulo* = 10

After the Timestamp Reset, the first acquisition is made when the Modulo reaches the programmed start time. Acquisitions repeat at every +10 Timestamp ticks until stopped. A number of initial frames may not be output by the camera to let the sensor operating conditions stabilize.

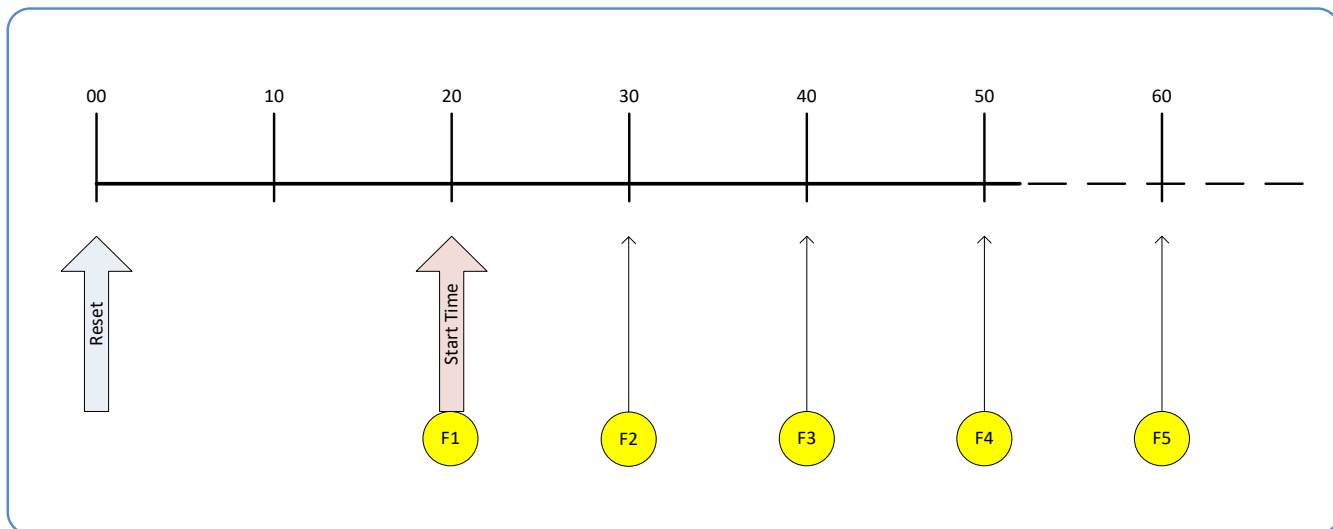

## Case 2: Simple Repeating Acquisitions with Start Time in the Past

### Conditions:

- initial *TimestampReset* resets Timestamp counter
- *timestampModulo* = 10
- at time=25, set *timestampModuloStartTime* = 20

Case 2 differs only from case 1 by showing that the start time may be in the past. In this case, the first Timestamp Modulo Event will be scheduled for the next time where the timestamp is equal to  $(timestampStartTime + N * timestampModulo)$ .

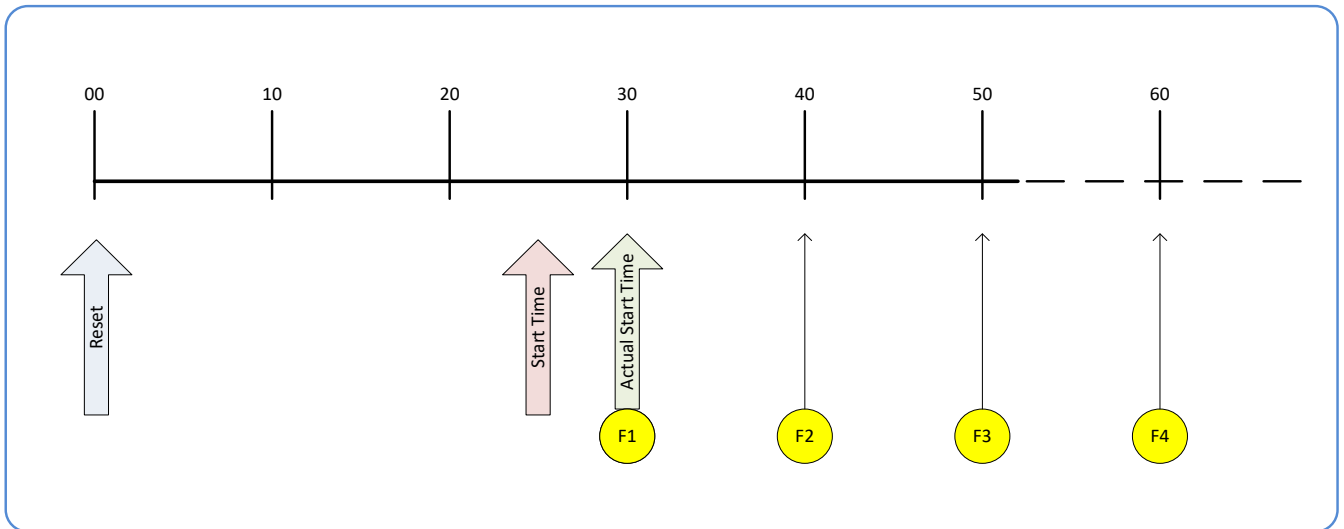

### Case 3: Potential Uncertainty to the Start Time

#### Conditions:

- initial *TimestampReset* resets Timestamp counter
- *timestampModulo* = 10
- at time=19, set *timestampModuloStartTime* = 20

Case 3 differs only from case 2 by showing that there is a period of uncertainty if the start time is too close to the first modulo count that follows. The first frame acquisition may occur at the first modulo count time or at the following. The actual value for the uncertainty period may vary with different camera and network conditions.

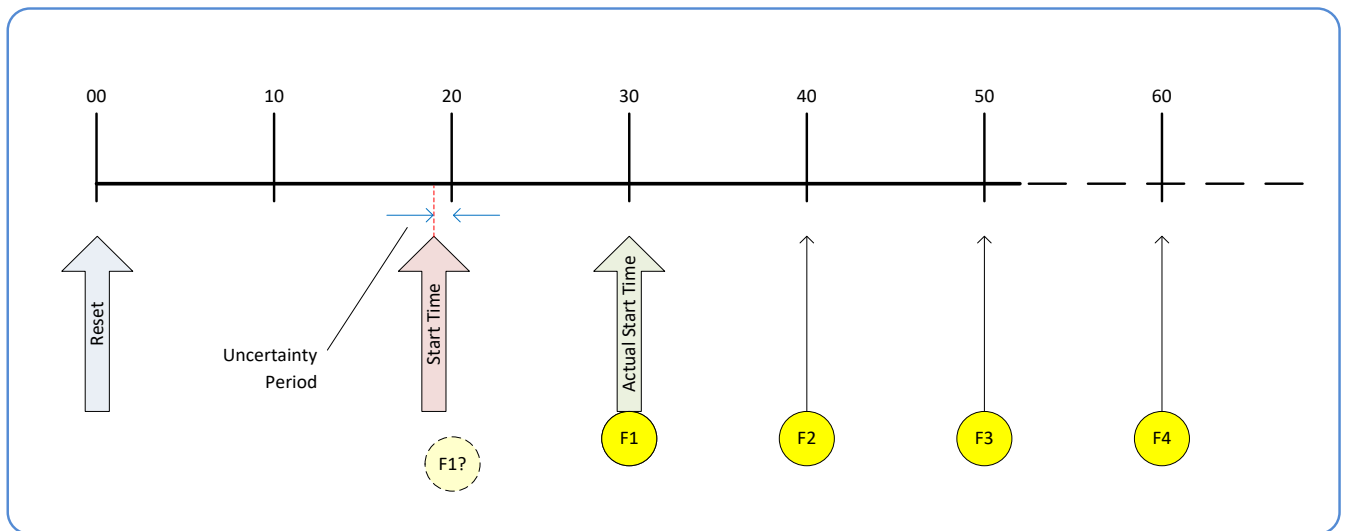

#### Case 4: Changing 'timestampModulo' during Acquisitions

##### Conditions:

- initial *TimestampReset* resets Timestamp counter
- *timestampModuloStartTime* = 20
- *timestampModulo* = 10
- *timestampModulo* changes to 20

Case 4 shows that the Modulo value can be changed dynamically. Using the simple example of case 1, after the third Modulo Event (F3) the Modulo value is changed from 10 to 20. The third acquisition now occurs at modulo 20 time following the previous acquisition.

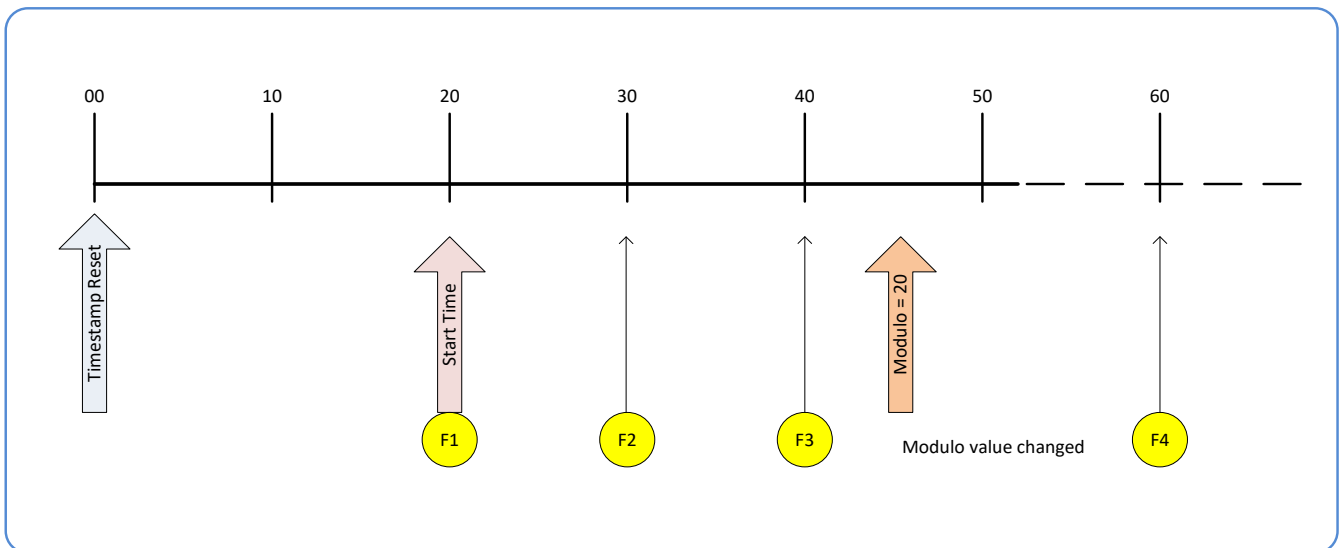

# I/O Controls Category

The I/O Controls category, as shown by CamExpert, groups features used to configure an external trigger input and acquisition actions based on the trigger. For more information on connecting an external trigger input, see the 10-pin I/O Connector Details section.

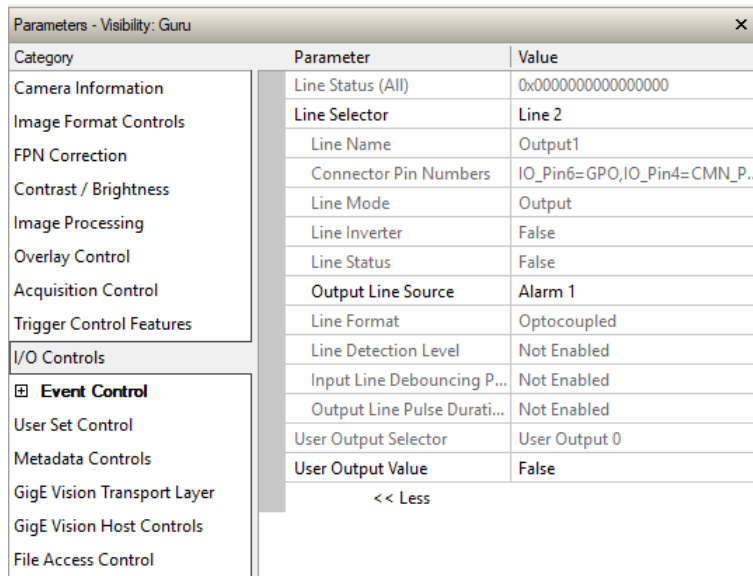

Figure 54: CamExpert I/O Controls Category

## I/O Controls Feature Descriptions

The following table describes these features along with their view attribute.

Table 25: I/O Controls Feature Descriptions

Display Name	Feature & Values	Description	View
Line Status (All)	LineStatusAll	Returns the current status of all available line signals, at the time of polling. The order, from LSB, is Line1, Line2, ...	Beginner
Line Selector	LineSelector	Selects the physical line (or pin) of the external device connector to configure.  <i>Line 1</i> <i>Line 2</i>	Beginner
Line Name	lineName	Name of the selected general input/output line.	Beginner DFNC
Connector Pin Numbers	linePinAssociation	Displays the description of the physical pin(s) associated with the logical line. The following abbreviations are used:  GPI = General Purpose Input GPO = General Purpose Output CMN_GND = Common Ground CMN_PWR = Common Power	Beginner DFNC

Display Name	Feature & Values	Description	View
Line Mode  <i>Input</i> <i>Output</i>	LineMode  <i>Input</i> <i>Output</i>	Reports if the physical Line is an Input or Output signal.  The line is an input line. The line is an output line.	Beginner
Line Status  <i>False</i> <i>True</i>	LineStatus  <i>False</i> <i>True</i>	Returns the current status of the selected input or output line.  Selected line signal status is low. Selected line signal status is high.	Beginner
Output Line Source  <i>Off</i> <i>User Output 0</i>  <i>User Output 1</i>  <i>Pulse on: Start of Readout</i> <i>Pulse on: Timestamp Modulo 1</i> <i>Pulse on: Timestamp Modulo 2</i>  <i>Alarm 1</i> <i>Alarm 2</i> <i>Alarm 3</i> <i>Any Alarm</i>	LineSource  <i>Off</i> <i>UserOutput0</i>  <i>UserOutput1</i>  <i>pulseOnStartofReadout</i> <i>pulseOnTimestampModulo1</i> <i>pulseOnTimestampModulo2</i>  <i>alarm1</i> <i>alarm2</i> <i>alarm3</i> <i>alarmAny</i>	Selects the internal signal or event to output on the selected output line.  Line output is set to high impedance. The <i>UserOutputValue</i> feature changes the output state. Starting with firmware 2.41, this value is flagged as deprecated but is kept for backwards compatibility with existing applications. Newer designs should use <i>UserOutput1</i> . The <i>UserOutputValue</i> feature changes the output state. Generate a pulse on the ReadoutStart event. Generate a pulse on the Timestamp Modulo Event 1. Generate a pulse on the Timestamp Modulo Event 2. Line will reflect the status of Alarm 1. Line will reflect the status of Alarm 2. Line will reflect the status of Alarm 3. Line will be activated if any alarm is triggered.	Beginner
Line Format  <i>Opto-Coupled</i>	LineFormat  <i>OptoCoupled</i>	Specify the current electrical format of the selected physical input or output.  The line is opto-Coupled.	Expert
Line Detection Level  <i>2.4 V</i>	lineDetectionLevel  <i>Threshold_2v4</i>	Line threshold is 2.4 V to be considered a valid signal.	Beginner DFNC
Input Line Debouncing Period	lineDebouncingPeriod	Specifies the minimum width, in microseconds, of an input pulse before it is recognized as a valid event (that triggers a frame and/or increments a Counter). Setting this value to 0 disables the digital debouncing, in which case the minimum pulse width is still limited by the camera's input circuit. See <a href="#">External Input AC Timing Characteristics</a> for more details.	Beginner DFNC
Output Line Pulse Duration	outputLinePulseDuration	Sets the duration (width) of the output line pulse, in microseconds. Applicable when the <i>LineSource</i> feature is set to <i>pulseOnStartofReadout</i> .	Beginner DFNC
User Output Selector	UserOutputSelector	Selects which bit of the User Output register will be set by the <i>UserOutputValue</i> feature.	Expert
User Output Value  <i>True</i> <i>False</i>	UserOutputValue  <i>True</i> <i>False</i>	Sets the value of the bit selected by the <i>UserOutputSelector</i> feature.  User output value is set to 1 (True). User output value is set to 0 (False).	Expert

# Event Control Category

The Event Control category, as shown by CamExpert, has parameters used to configure Camera Event related features.

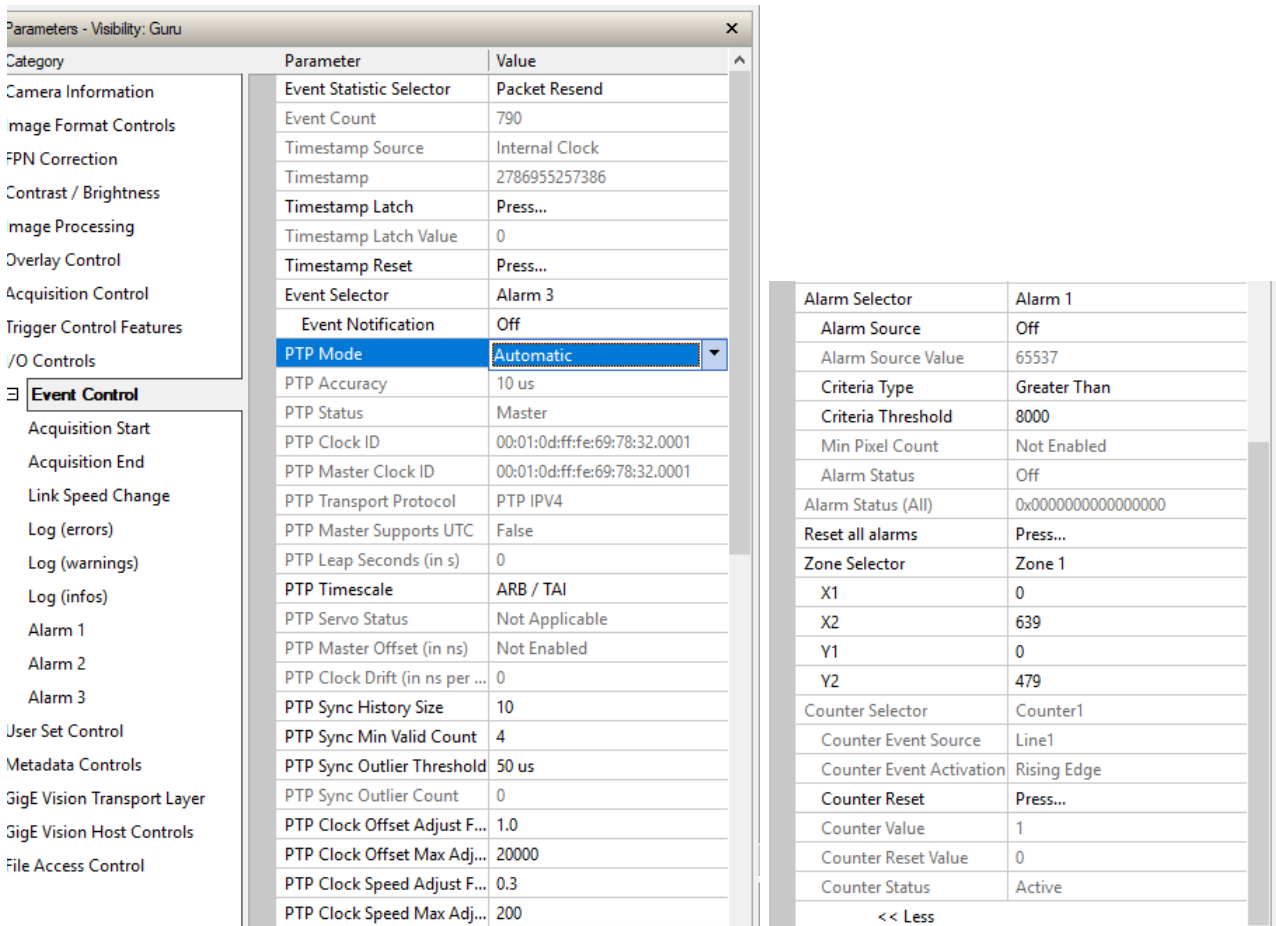

Figure 55: CamExpert Event Control Category

## Event Control Feature Descriptions

The following table describes these parameters along with their view attribute.

Table 26: Event Control Feature Descriptions

Display Name	Feature & Values	Description	View
Event Statistic Selector	eventStatisticSelector	Selects which Event statistic count to display.	Expert
<i>Packet Resend</i>	<i>PacketResend</i>	Counts the number of individual packets that are resent.	
<i>Packet Resend Request Dropped</i>	<i>PacketResendRequestDropped</i>	Counts the number of packet resend requests dropped. The camera queues the packet resend requests until they are processed. There is a limit to the number of requests that can be queued by the camera. When a new request is received and the queue is full, the request is dropped but this statistic is still incremented.	
<i>Invalid Frame Trigger</i>	<i>InvalidFrameTrigger</i>	Counts the frame triggers occurring in an invalid Trigger region.	
<i>Image Lost</i>	<i>ImageLost</i>	Number of images lost due to insufficient memory or Ethernet bandwidth.	
<i>Ethernet Pause Frame Received</i>	<i>EthernetPauseFrameReceived</i>	Counts the number of Ethernet Pause Frames received by the camera.	



Display Name	Feature & Values	Description	View
Event Count	eventStatisticCount	Display the count of the selected Event.	Expert DFNC
TimeStamp Source	timestampSource	Specifies the source used as the incrementing signal for the Timestamp register.	Expert DFNC
<i>Internal Clock</i>	<i>InternalClock</i>	The timestamp source is generated by the camera internal clock.	
<i>IEEE1588</i>	<i>IEEE1588</i>	The internal timestamp register is controlled by the network IEEE1588 protocol. This source is automatically selected when PTP mode is enabled.	
Timestamp	Timestamp	Returns the 64-bit value of the timestamp, in nanoseconds.	Expert
Timestamp Latch Cmd	TimestampLatch	Latches the current timestamp internal counter value in the <i>Timestamp</i> feature.	Expert
Timestamp Latch Value	TimestampLatchValue	Returns the 64-bit value of the timestamp when the <i>TimestampLatch</i> command was asserted.	Expert
Timestamp Reset	TimestampReset	Resets the timestamp counter to 0. Note that if the PTP Mode is enabled and the camera is PTP Slave, its Timestamp will synchronize back with the PTP Master's clock.	Expert
Event Selector	EventSelector	Select the Event to enable/disable with the EventNotification feature.	Expert
<i>Acquisition Start</i>	<i>AcquisitionStart</i>	Event sent on control channel when the AcquisitionStart command is received.	
<i>Acquisition End</i>	<i>AcquisitionEnd</i>	Event sent on control channel when the AcquisitionEnd command is received.	
<i>Link Speed Change</i>	<i>LinkSpeedChange</i>	Event sent on control channel when the link speed changes.	
<i>Log (errors)</i>	<i>logError</i>	Event sent on control channel when an error occurs.	
<i>Log (warnings)</i>	<i>logWarning</i>	Event sent on control channel when a warning message is issued.	
<i>Log (infos)</i>	<i>logInfo</i>	Event sent on control channel when an informative message is issued.	
<i>Alarm 1</i>	<i>Alarm1</i>	Event sent on control channel when Alarm 1 is triggered.	
<i>Alarm 2</i>	<i>Alarm2</i>	Event sent on control channel when Alarm 2 is triggered.	
<i>Alarm 3</i>	<i>Alarm3</i>	Event sent on control channel when Alarm 3 is triggered.	
<i>FPN Calibration Start</i>	<i>FPNCalibrationStart</i>	Event sent on control channel when FPN calibration is started.	
<i>FPN Calibration Start</i>	<i>FPNCalibrationEnd</i>	Event sent on control channel when FPN calibration has completed (successfully or not).	
Event Notification	EventNotification	Enable Events for the event type selected by the EventSelector feature.	Expert
<i>Off</i>	<i>Off</i>	The selected event is disabled.	
<i>On</i>	<i>On</i>	The selected event will generate a software event.	
<i>Once</i>	<i>Once</i>	The selected event is enabled once and will be disabled after.	
<a href="#">PTP Mode</a>	ptpMode	Specifies the PTP (IEEE-1588: Precision Time Protocol) operating mode as implemented by the A68/A38.	Beginner DFNC
<i>Off</i>	<i>Off</i>	PTP is disabled on the device.	

Display Name	Feature & Values	Description	View
<i>Automatic</i>	<i>Automatic</i>	PTP is enabled on the device. The camera can become a Master or Slave device. The Master device is automatically determined as per IEEE-1588.	
PTP Accuracy	ptpClockAccuracy	Indicates the expected accuracy of the PTP synchronization.	Expert DFNC
PTP Status	ptpStatus	Specifies dynamically the current PTP state of the device. (ref: IEEE Std 1588-2008)	Guru DFNC
<i>Initializing</i>	<i>Initializing</i>	The port initializes its data sets, hardware, and communication facilities.	
<i>Faulty</i>	<i>Faulty</i>	The fault state of the protocol.	
<i>Disabled</i>	<i>Disabled</i>	The port shall not place any messages on its communication path.	
<i>Listening</i>	<i>Listening</i>	The port is waiting for the announceReceiptTimeout to expire or to receive an Announce message from a master. The purpose of this state is to allow orderly addition of clocks to a domain. A port in this state shall not place any PTP messages on its communication path except for Pdelay_Req, Pdelay_Resp, Pdelay_Resp_Follow_Up, or signaling messages, or management messages that are a required response to another management message.	
<i>Master</i>	<i>Master</i>	The port is behaving as a master port.	
<i>Passive</i>	<i>Passive</i>	The port shall not place any messages on its communication path except for Pdelay_Req, Pdelay_Resp, Pdelay_Resp_Follow_Up, or signaling messages, or management messages that are a required response to another management message.	
<i>Slave</i>	<i>Slave</i>	The port is synchronizing to the selected master port.	
PTP Clock ID	ptpClockId	PTP port identity of the device, printed as xxxxxxxxxxxxxxxx.yyyy, where x=clock ID and y=port number (both in hexadecimal notation) The clock ID is an Extended Unique Identifier (EUI)-64 64-bit ID, converted from the 48-bit MAC address, by inserting 0xfffe at the middle of the MAC address and terminating with the port number: yyyy.	Expert DFNC
PTP Master Clock ID	ptpMasterClockId	PTP port identity of the current master, printed as xxxxxxxxxxxxxxxx.yyyy, where x=clock ID and y=port number (both in hexadecimal notation)	Expert DFNC
PTP Master Offset	ptpMasterOffsetNs	Dynamically returns the 64-bit value of the PTP offset with the master. This value is the input for clock corrections for the slave device clock servo algorithms.	Expert DFNC
PTP Transport Protocol	ptpTransportProtocol	Displays the PTP Transport Protocol used. In the current implementation, PTP runs over UDP/IPV4	Guru DFNC
PTP Master Supports UTC	ptpUTCAvailable	Indicates if the current PTP Master supports UTC timescale, that is, if it reports the number of leap seconds between the UTC timescale ("Earth time") and the TAI timescale ("Atomic time").	Guru DFNC
PTP Leap Seconds (in s)	ptpUTCLeapSeconds	Offset, in seconds between UTC and TAI.	Guru DFNC

Display Name	Feature & Values	Description	View
PTP Timescale  <i>ARB / TAI</i> <i>UTC</i>	ptpTimescale  <i>TimescaleArbTai</i> <i>TimescaleUtc</i>	Timescale used to report time values. If using UTC (and the PTP Master supports it), the camera will compensate for leap seconds.  Arbitrary or TAI (Temps Atomique International). Coordinated Universal Time	Guru DFNC
PTP Servo Status  <i>Synchronizing</i>  <i>Locked</i>  <i>Not Applicable</i>	ptpServoStatus  <i>Synchronizing</i>  <i>Locked</i>  <i>NotApplicable</i>	Specifies the IEEE1588 servo status.  The servo is accumulating statistics on the PTP master clock.  The servo is adjusting (synchronizing) to the master clock.  The servo state is currently not applicable.	Guru DFNC
PTP Clock Drift (in ns per second)	ptpClockDrift	Clock drift, in ns per second, between the camera and the PTP master, currently being compensated by the camera.	Expert DFNC
PTP Sync History Size	ptpSyncHistorySize	Used when the camera is running as PTP slave. The PTP Sync History is the number of of recent PTP Sync messages kept in memory. If the history contains less than the <a href="#">ptpSyncMinCount</a> non-outliers, the PTP servo algorithm will revert back to the Synchronizing state.	
PTP Sync Min Valid Count	ptpSyncMinCount	Minimum number of non-outliers in PTP Sync History.	Guru DFNC
PTP Sync Outlier Threshold  <i>Threshold_10</i> <i>Threshold_20</i> <i>Threshold_30</i> <i>Threshold_40</i> <i>Threshold_50</i> <i>Threshold_60</i> <i>Threshold_80</i> <i>Threshold_100</i> <i>Threshold_120</i> <i>Threshold_150</i> <i>Threshold_200</i> <i>Threshold_500</i> <i>Threshold_1000</i> <i>Threshold_2000</i>	ptpServoStepThreshold  <i>Threshold_10</i> <i>Threshold_20</i> <i>Threshold_30</i> <i>Threshold_40</i> <i>Threshold_50</i> <i>Threshold_60</i> <i>Threshold_80</i> <i>Threshold_100</i> <i>Threshold_120</i> <i>Threshold_150</i> <i>Threshold_200</i> <i>Threshold_500</i> <i>Threshold_1000</i> <i>Threshold_2000</i>	Specifies the outlier threshold (in $\mu\text{s}$ ). When the camera receives a PTP Sync message from the PTP Master, if it indicates a clock offset between the two clocks higher than the threshold, an error caused by variations in network transmission time for the PTP Sync packet is assumed, and the message is considered an outlier and ignored. This situation can happen when using Ethernet switches that do not operate in 'PTP Transparent' mode.  Outlier threshold = 10 $\mu\text{s}$ Outlier threshold = 20 $\mu\text{s}$ Outlier threshold = 30 $\mu\text{s}$ Outlier threshold = 40 $\mu\text{s}$ Outlier threshold = 50 $\mu\text{s}$ Outlier threshold = 60 $\mu\text{s}$ Outlier threshold = 80 $\mu\text{s}$ Outlier threshold = 100 $\mu\text{s}$ Outlier threshold = 120 $\mu\text{s}$ Outlier threshold = 150 $\mu\text{s}$ Outlier threshold = 200 $\mu\text{s}$ Outlier threshold = 500 $\mu\text{s}$ Outlier threshold = 1000 $\mu\text{s}$ Outlier threshold = 2000 $\mu\text{s}$	Expert DFNC
PTP Sync Outlier Count	ptpServoOutlierCount	Number of PTP Sync outliers received since the camera booted.	Guru DFNC

Display Name	Feature & Values	Description	View
PTP Clock Offset Adjust Factor	ptpClockOffsetAdjustFactor	Sets the PTP clock adjust factor. When the camera is a PTP slave, it adjusts its clock to match the PTP master's clock. When the camera receives a PTP Sync message, it computes the clock offset between the camera and the PTP master. This offset value is multiplied by <i>ptpClockOffsetAdjustFactor</i> and used to adjust the camera clock offset, compensating for past errors. When <i>ptpClockOffsetAdjustFactor</i> is 1.0, the camera instantly adjusts to the master clock, making it more sensitive to variations in network transmission time of PTP Sync packets.	Guru DFNC
PTP Clock Offset Max Adjust (in ns)	ptpClockOffsetMaxAdjust	Maximum clock offset adjustment, in nanoseconds, that can be done when the camera receives a PTP Sync (and PTP Servo Status is "Locked").	Guru DFNC
PTP Clock Speed Adjust Factor	ptpClockSpeedAdjustFactor	Sets the PTP clock speed adjust factor. When the camera is a PTP slave, it adjusts its clock to match the PTP master's clock. When the camera receives a PTP Sync message, it computes the clock offset between the camera and the PTP master. This offset value is multiplied by <i>ptpClockSpeedAdjustFactor</i> and used to adjust the camera clock offset, compensating for future errors. When <i>ptpClockSpeedAdjustFactor</i> is 1.0, the camera instantly adjusts to the master clock, making it more sensitive to variations in network transmission time of PTP Sync packets.	Guru DFNC
PTP Clock Speed Max Adjust (in ns per s)	ptpClockSpeedMaxAdjust	Maximum clock speed adjustment, in nanoseconds per second, that can be done when the camera receives a PTP Sync.	Guru DFNC
Alarm Selector	alarmSelector	Specifies the alarm to configure. <i>Alarm 1</i> Selects <i>Alarm1</i> . <i>Alarm 2</i> Selects <i>Alarm2</i> . <i>Alarm 3</i> Selects <i>Alarm3</i> .	Beginner DFNC
Alarm Source	alarmSource	Selects which value will be monitored for this alarm. <i>Off</i> Deactivates this alarm. <i>Zone 1 Average</i> Alarm will be triggered if the average pixel value in Zone 1 meets a certain criteria. <i>Zone 1 Pixel Count</i> Alarm will be triggered if a minimum number of raw sensor pixels in Zone 1 meet a certain criteria. <i>Zone 2 Average</i> Alarm will be triggered if the average pixel value in Zone 2 meets a certain criteria. <i>Zone 2 Pixel Count</i> Alarm will be triggered if a minimum number of raw sensor pixels in Zone 2 meet a certain criteria. <i>Camera Temperature</i> Alarm will be triggered if the camera's internal temperature (measured as the Processor's temperature) exceed a certain criteria.	Beginner DFNC
Alarm Source Value	alarmSourceValue	Returns the latest value of the source being monitored by the selected Alarm.	Beginner DFNC

Display Name	Feature & Values	Description	View
Criteria Type  <i>Less Than</i>	alarmCriteria  <i>LessThan</i>	Selects which criteria must be met by the monitored value before an alarm is triggered.  For Pixel Count-type alarms, a pixel will be counted if its value is less than the Criteria Threshold. For other alarms, alarm will be triggered if the Alarm Source Value is less than the Criteria Threshold.	Beginner DFNC
<i>Greater Than</i>	<i>GreaterThan</i>	For Pixel Count-type alarms, a pixel will be counted if its value is greater than the Criteria Threshold. For other alarms, alarm will be triggered if the Alarm Source Value is greater than the Criteria Threshold.	
Criteria Threshold	alarmCriteriaThreshold	Sets the threshold value for which an alarm is triggered.	Beginner DFNC
Min Pixel Count	alarmPixelCountThreshold	For Pixel Count-type alarms, this represents the minimum number of pixels that must meet the alarm criteria before the alarm is triggered.	Beginner DFNC
Alarm Status  <i>Off</i> <i>On</i>	alarmStatus  <i>Off</i> <i>On</i>	Returns the status of the currently selected alarm. Once triggered, alarm will remain active until it is reset.  Alarm is not active.  Alarm is active.	Beginner DFNC
Reset All Alarms	alarmResetAll	Resets all alarms.	
<b>Counter</b>			
Counter Selector  <i>Counter1</i>	CounterSelector  <i>Counter1</i>	Specifies the counter being accessed.  Selects Counter 1.	Beginner
Counter Event Source  <i>Line1</i>	CounterEventSource  <i>Line1</i>	Selects the event source to increment the counter.  Counts the number of transistions on Line 1 input.	
Counter Event Activation  <i>Rising Edge</i>	CounterEventActivation  <i>RisingEdge</i>	Selects the activation mode for the event source signal  Rising edge signal transition increases the selected counter.	Beginner
Counter Reset	CounterReset	Performs a software reset of the selected counter and starts it. The counter starts counting events immediately after the reset.	Expert
Counter Value	CounterValue	Reads the current value of the selected counter.	Beginner
Counter Reset Value	CounterValueAtReset	Reads the value of the selected counter when it was reset by a <i>CounterReset</i> command.	Beginner
Counter Status  <i>Active</i>	CounterStatus  <i>Active</i>	Returns the current status of the counter.  Counter is counting.	Beginner
<b>Event</b>			
Acquisition Start	EventAcquisitionStart	Represents the event ID to identify the EventAcquisitionStart event.	Guru
Acquisition End	EventAcquisitionEnd	Represents the event ID to identify the EventAcquisitionEndt event.	Beginner
Link Speed Change	EventLinkSpeedChange	Represents the event ID to identify the EventLinkSpeedChange event.	Guru
Log (errors)	EventlogError	Represents the event ID to identify the EventlogError event.	Guru
Log (warnings)	EventlogWarning	Represents the event ID to identify the EventlogWarning event.	Guru
Log (infos)	EventlogInfo	Represents the event ID to identify the EventlogInfo event.	Guru

## Overview of Precision Time Protocol Mode (IEEE 1588)

### PTP Mode = Precision Time Protocol

- The PTP protocol synchronizes the Timestamp clocks of multiple devices connected via a switch on the same network, where the switch supports forwarding of PTP messages.
- For optimal clock synchronization the imaging network should use one Ethernet switch. Daisy-chaining multiple small switches will degrade camera clock syncs.
- A68/A38 cameras can automatically organize themselves into a master-slave hierarchy, or the user application configures a camera master with n-number of slaves.
- The automatic organizing procedure is composed of steps (as defined by IEEE 1588) to identify the best clock source to act as master. When only A68/A38 cameras are used, since they are equal, the last selection step is to identify the A68/A38 with lowest value MAC address to be the clock master.
- The feature *TimeStampSource* is automatically changed to *IEEE1588* when *PTP Mode* is enabled.
- The A68/A38 cameras implement additional features designed to synchronize multiple camera acquisitions via IEEE 1588 (PTP Mode) – for example using timestamp modulo events, not via external camera trigger signals.

### *PTP Master Clock Identity*

The clock ID of the current best master is an Extended Unique Identifier (EUI)-64 “64-bit ID”, converted from the 48-bit MAC address, by inserting 0xffff at the middle of the MAC address.

- The standard MAC address in human-friendly form is six groups of two hexadecimal digits as this example shows (excluding hyphens ): “0a-1b-2c-3d-4e-5f”
- The Extended Unique Identifier format is (excluding hyphens): “0a-1b-2c-ff-fe-3d-4e-5f”

### ***An Example with two A68/A38 Cameras***

The following basic steps configure two A68/A38 cameras connected to one computer via an Ethernet switch, configured with two instances of CamExpert, to grab a frame every second, controlled by a modulo event via PTP.

**For each camera set features as follows:**

**I/O Controls** — select Trigger Mode=ON, Trigger Source=Timestamp Modulo Event

**Event Controls** — select PTP Mode=Automatic

- Note how one A68/A38 automatically becomes Master while the other becomes Slave

**Event Controls** — to have a modulo event every second, set Timestamp Modulo Event=1000000000 (nanoseconds)

Click Grab on each instance of CamExpert. With the two cameras aimed at the same moving object, you see that each camera grabs a frame at the same time.

### ***IEEE 1588 Reference Resources***

For additional information: <http://standards.ieee.org>

PTP Standard Reference: IEEE Std 1588-2008 — IEEE Standard for a Precision Clock Synchronization Protocol for Networked Measurement and Control Systems.



**Note:** When using an external Grand Master clock, please make sure it is configured to broadcast a limited number of SYNC messages per second. Some devices are configured by default to output 128 SYNC messages per second which is not necessary for typical A68/A38 operation but burdens the camera and can lead to instability.

## User Set Control Category

The User Set Control category, as shown by CamExpert, allows users to select the power-up configuration. In addition, CamExpert provides a dialog box, available through the Power-up Configuration feature in the Camera Information category, which combines the features to select the camera power-up state and for the user to save or load a A68/A38 camera state: for more information refer to the Power-up Configuration Dialog section.

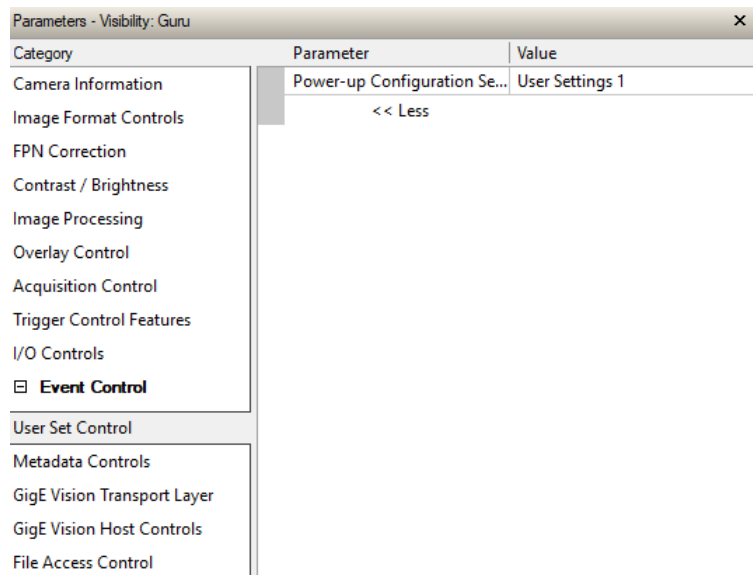

Figure 56: CamExpert User Set Control Category

## User Set Control Feature Descriptions

The following table describes these parameters along with their view attribute.

Table 27: User Set Control Feature Descriptions

Display Name	Feature & Values	Description	View
<u>Power-up Configuration Selector</u>	UserSetDefaultSelector	Selects the camera configuration set to load and make active on camera power-up or reset. The camera configuration sets are stored in camera non-volatile memory. (RW)	Beginner
<i>Factory Setting</i>	<i>Default</i>	Load factory default feature settings.	
<i>User Settings 1</i>	<i>UserSet1</i>	Select the User Defined Configuration space <i>UserSet1</i> to save to or load from features settings previously saved by the user.	
<i>User Settings 2</i>	<i>UserSet2</i>	Select the User Defined Configuration space <i>UserSet2</i> to save to or load from features settings previously saved by the user.	



# Metadata Controls Category

The Metadata Controls, as shown by CamExpert, groups features to enable and select inclusion of chunk data with the image payload (as specified by the specification GigE Vision 1.1).

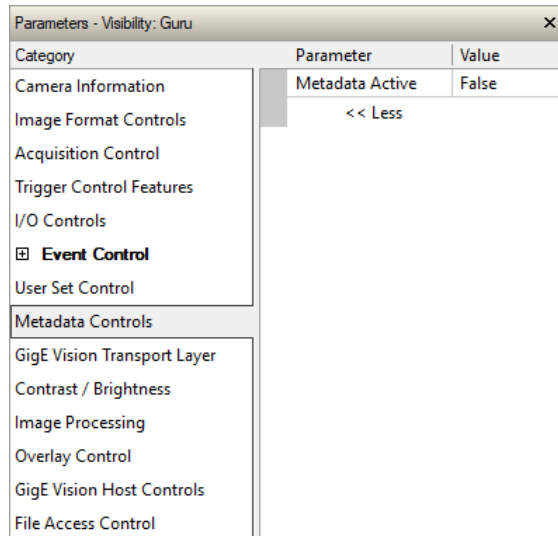

Figure 57: CamExpert Metadata Controls

For information on the metadata format and extracting the metadata from image buffers, refer to the Metadata section.

## Metadata Controls Feature Descriptions

The following table describes these features along with their view attribute.

Table 28: Metadata Controls Feature Descriptions

Display Name	Feature & Values	Description	View
Metadata Mode	ChunkModeActive	Activates the appending of chunk data (metadata) to the payload of the image. Access to metadata requires the <a href="#">GevSCCFGExtendedChunkData</a> feature in the GigE Vision Transport Layer category to be activated.	Expert
<i>False</i>	<i>False</i>	No chunk data.	
<i>True</i>	<i>True</i>	Chunk data included in payload.	

## GigE Vision Transport Layer Category

The GigE Vision Transport Layer category, as shown by CamExpert, groups parameters used to configure features related to GigE Vision specification and the Ethernet Connection.

Category	Parameter	Value
Camera Information	Supported Options Selector	LLA
Image Format Controls	Option Supported	True
Acquisition Control	Interface MAC Address	0C:C3:15:40:00:00
Trigger Control Features	LLA	True
I/O Controls	DHCP	True
<input checked="" type="checkbox"/> <b>Event Control</b>	Persistent IP	False
User Set Control	Current IP Address	169.254.1.0
Metadata Controls	Current Subnet Mask	255.255.0.0
GigE Vision Transport Layer	Current Default Gateway	0.0.0.0
Contrast / Brightness	IP Configuration Status	Link-Local
Image Processing	Persistent IP Address	172.16.230.39
Overlay Control	Persistent Subnet Mask	255.255.0.0
GigE Vision Host Controls	Persistent Default Gateway	192.168.1.1
File Access Control	IP Configuration	DHCP
	Device Access Privilege Control	Control Access
	Primary Application Socket	62726
	Primary Application IP Address	169.254.163.66
	Messaging Host Port	62728
	Messaging Host IP	169.254.163.66
	Messaging Timeout (in ms)	0
	Messaging Retransmissions Count	0
	Messaging Device Port	14399
	Metadata Enable	True
	Streaming Interface Index	0
	Streaming Host Port	0
	Fire Test Packet	False
	GevSCPSPDoNotFragment	True
	PacketSize	1496
	Inter-Packet Delay (in us)	0
	Stream Destination IP	0.0.0.0
	Streaming Source Port	0

Figure 58: CamExpert GigE Vision Transport Layer Category



Display Name	Feature & Values	Description	View
Persistent Subnet Mask	GevPersistentSubnetMask	Persistent subnet mask for the selected interface.	Guru
Persistent Default Gateway	GevPersistentDefaultGateway	Persistent default gateway for the selected interface.	Guru
IP Configuration <i>Link-Local</i> <i>DHCP</i> <i>Persistent IP</i>	GevIPConfiguration  <i>LLA</i> <i>DHCP</i> <i>PersistentIP</i>	Sets the camera IP configuration. Link-Local Address Mode Dynamic Host Configuration Protocol Mode. Network requires a DHCP server. Persistent IP Mode (static)	Guru
Device Access Privilege Control <i>Open Access</i> <i>Exclusive Access</i> <i>Control Access</i>	GevCCP  <i>OpenAccess</i> <i>ExclusiveAccess</i> <i>ControlAccess</i>	Controls the device access privilege of an application. <i>OpenAccess</i> Grants exclusive access to the device to an application. No other application can control or monitor the device. Grants control access to the device to an application. No other application can control the device.	Guru
Primary Application Socket	GevPrimaryApplicationSocket	Returns the UDP (User Datagram Protocol) source port of the primary application.	Guru
Primary Application IP Address	GevPrimaryApplicationIPAddress	Returns the IP address of the device hosting the primary application. (RO)	Guru
Messaging Host Port	GevMCPHostPort	Specifies the port to which the device must send messages.	Guru
Messaging Host IP	GevMCDA	Indicates the destination IP address for the message channel. (RO)	Guru
Messaging Timeout (in ms)	GevMCTT	Provides the transmission timeout value in milliseconds.	Guru
Messaging Retransmissions Count	GevMCRC	Indicates the number of retransmissions allowed when a message channel message times out.	Guru
Messaging Device Port	GevMCSP	This feature indicates the source port for the message channel. (RO)	Guru
Metadata Enable	GevSCCFGExtendedChunkData	Sets the enable state of the inclusion of metadata in the image payload. To generate and insert the actual metadata, set the Metadata Active ( <i>ChunkModeActive</i> ), in the Metadata Controls Category, to <i>True</i> .	Guru
Streaming Interface Index	GevSCPIInterfaceIndex	Index of network interface.	Beginner
Streaming Host Port	GevSCPHostPort	Specifies the port to which the device must send the data stream.	Guru
Fire Test Packet	GevSCPSFireTestPacket	When this feature is set to <i>True</i> , the device will fire one test packet.	Guru
GevSCPSDoNotFragment	GevSCPSDoNotFragment	This feature state is copied into the "do not fragment" bit of IP header of each stream packet.	Guru
PacketSize	GevSCPSPacketSize	Specifies the stream packet size in bytes to send on this channel.	Expert
Inter-Packet Delay	GevSCPD	Indicates the delay (in $\mu$ s) to insert between each packet for this stream channel.	Expert
Stream Destination IP	GevSCDA	Indicates the destination IP address for this stream channel.	Guru
Streaming Source Port	GevSCSP	Indicates the source port of the stream channel.	Guru

---

## GigE Vision Host Control Category

The GigE Vision Host controls, as shown by CamExpert, groups parameters used to configure the host computer system GigE Vision features used for A68/A38 networking management. None of these parameters are stored in the FLIR A68/A38 series camera.

These features allow optimizing the network configuration for maximum bandwidth. Settings for these parameters are highly dependent on the number of cameras connected to a NIC, the data rate of each camera and the trigger modes used.

Information on these features is found in the Teledyne DALSA Network Imaging Module User manual.

---

## File Access Control Category

The File Access control in CamExpert allows the user to quickly upload various data files to the connected A68/A38. The supported data files are for firmware updates, etc.

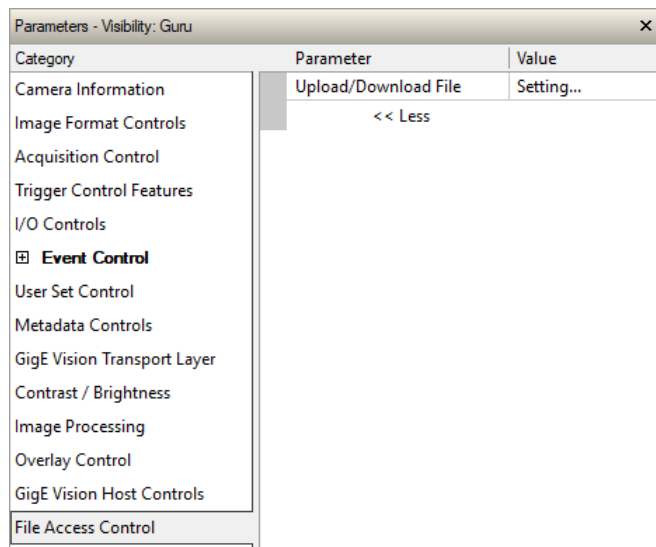

Figure 59: CamExpert File Access Control Category

## File Access Control Feature Descriptions

The following table describes these parameters along with their view attribute.

Table 30: File Access Control Feature Descriptions

Display Name	Feature & Values	Description	View
File Selector	FileSelector	Selects the file to access. The file types which are accessible are device-dependent.	Guru
<i>Firmware</i>	<i>Firmware1</i>	Upload new firmware to the camera which will execute on the next camera reboot cycle. Select the DeviceReset feature after the upload completes.	
<i>Error Log</i>	<i>CrashLog</i>	Camera error log.	
<i>Current Log</i>	<i>CurrentLog</i>	Current camera log.	
<i>User Defect Pixel Map</i>	<i>FactoryDefectMap</i>	Factory calibrated defective pixel map.	
<i>User Defect Pixel Map</i>	<i>UserDefectPixelMap</i>	User generated defective pixel map. The defective pixel image map is an 8-bit .bmp file containing black (0) and non-zero pixels (1-255) with non-zero pixels identifying defective pixels. The image must be the same size as the acquisition image. For more information, see the <a href="#">Defective Pixel Correction</a> section.	
<i>User Defined Image1</i>	<i>UserDefinedImage1</i>	User-defined pattern (.bmp file, 640x480, mono8)	
<i>User set 1</i>	<i>UserSet1</i>	File used to download the user settings to the host or upload another camera's user settings to this camera.	
<i>User set 2</i>	<i>UserSet2</i>	File used to download the user settings to the host or upload another camera's user settings to this camera.	
<i>Software Licenses</i>	<i>SoftwareLicenses</i>	Software license notices.	
<i>False Color Map</i>	<i>ColorMap</i>	Custom false color map (.bmp file, 640x1, RGB888).	
File Operation Selector	FileOperationSelector	Selects the target operation for the selected file in the device. This operation is executed when the File Operation Execute feature is called.	Guru
<i>Open</i>	<i>Open</i>	Select the Open operation - executed by FileOperationExecute.	
<i>Close</i>	<i>Close</i>	Select the Close operation - executed by FileOperationExecute.	
<i>Read</i>	<i>Read</i>	Select the Read operation - executed by FileOperationExecute.	
<i>Write</i>	<i>Write</i>	Select the Write operation - executed by FileOperationExecute.	
<i>Delete</i>	<i>Delete</i>	Select the Delete operation - executed by FileOperationExecute.	
File Operation Execute	FileOperationExecute	Executes the operation selected by File Operation Selector on the selected file.	Guru
File Open Mode	FileOpenMode	Selects the access mode used to open a file on the device.	Guru
<i>Read</i>	<i>Read</i>	Select READ only open mode	
<i>Write</i>	<i>Write</i>	Select WRITE only open mode	
File Access Buffer	FileAccessBuffer	Defines the intermediate access buffer that allows the exchange of data between the device file storage and the application.	Guru
File Access Offset	FileAccessOffset	Controls the mapping offset between the device file storage and the file access buffer.	Guru
File Access Length	FileAccessLength	Controls the mapping length between the device file storage and the file access buffer.	Guru

Display Name	Feature & Values	Description	View
File Operation Status	FileOperationStatus	Displays the file operation execution status.	Guru
<i>Success</i>	<i>Success</i>	The last file operation has completed successfully.	
<i>Failure</i>	<i>Failure</i>	The last file operation has completed unsuccessfully for an unknown reason.	
<i>File Unavailable</i>	<i>FileUnavailable</i>	The last file operation has completed unsuccessfully because the file is currently unavailable.	
<i>File Invalid</i>	<i>FileInvalid</i>	The last file operation has completed unsuccessfully because the selected file is not present in this camera model.	
File Operation Result	FileOperationResult	Displays the file operation result. For Read or Write operations, the number of successfully read/written bytes is returned.	Guru
File Size	FileSize	Represents the size of the selected file in bytes.	Guru

### Updating Firmware via File Access in CamExpert

Click on the "Setting..." button to show the file selection menu.

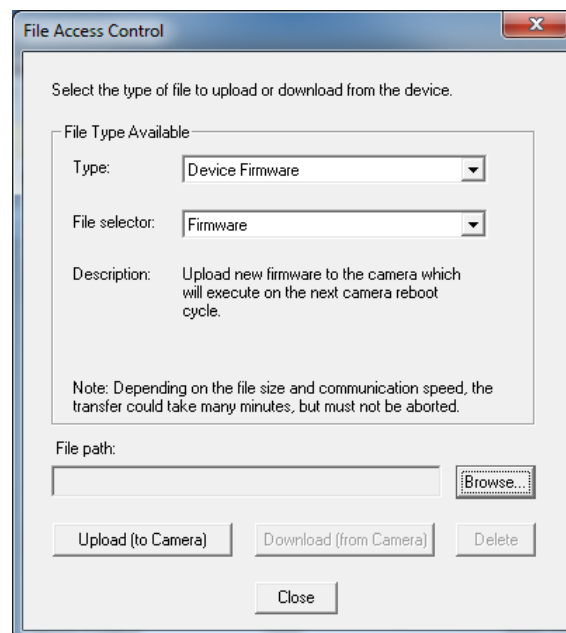

Figure 60: CamExpert File Access Control Category

- From the **File Type** drop menu, select the file **Type** that will be uploaded to the A68/A38. This CamExpert tool allows quick firmware changes or updates, when available for your A68/A38 model.
- From the **File Selector** drop menu, select the A68/A38 memory location for the uploaded data. This menu presents only the applicable data locations for the selected file type.
- Click the Browse button to open a typical Windows Explorer window.
- Select the specific file from the system drive or from a network location. Firmware files have a .CBF extension.
- Click the Upload button to execute the file transfer to the A68/A38.
- Reset the A68/A38 when prompted.

# Technical Specifications

## Mechanical Specifications

### FLIR A68/A38 Series with M25 Lens Mount

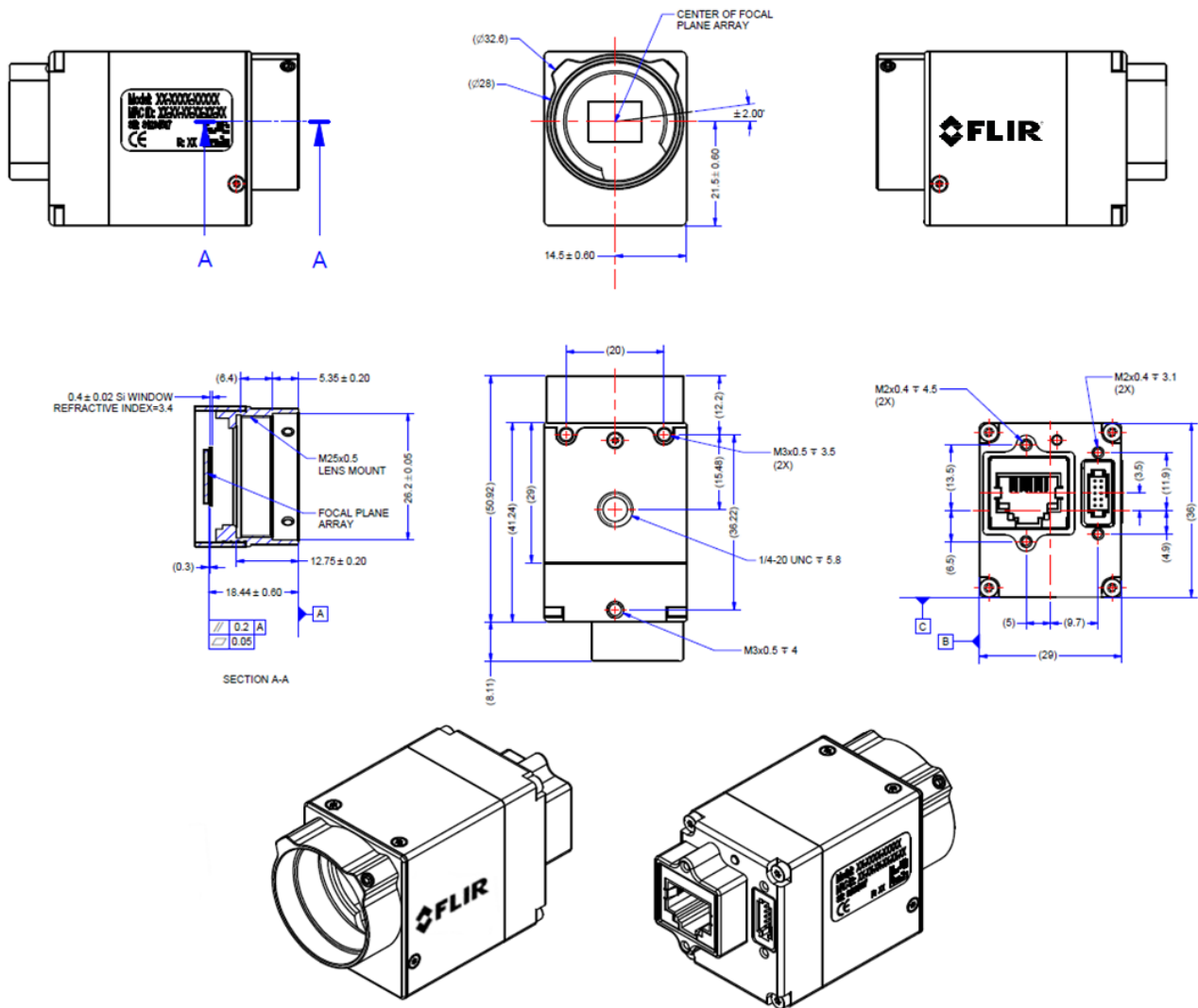

Figure 61: FLIR A68/A38 Series with M25 Lens Mount (mm units)



## Additional Notes on A68/A38 Identification and Mechanical



**Note:** The camera bottom has 4 mounting holes; one standard camera tripod ¼-20 mount and three M3 mounting holes, which provide good grounding capabilities.



**WARNING:** For cameras not equipped with a lens, do not touch the internal mechanical shutter; any physical contact to the shutter may render it unusable.

## Connectors

### 10-pin I/O Connector Details

FLIR A68/A38 series cameras are equipped with a Samtec 10-pin connector (Samtec TFM-105-02-L-D-WT). A68/A38 supports connecting cables with retention latches or screw locks. The following figure shows pin number assignment.

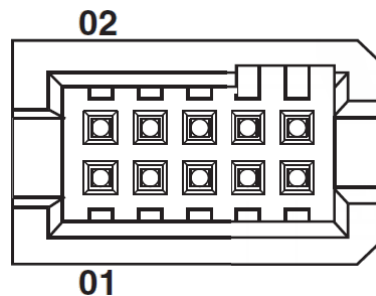

Figure 3: Samtec 10-Pin Connector

Teledyne FLIR provides an open-ended breakout cable. If other mating cables are required, ensure that cables are compatible with this connector (Samtec TFM-105-02-L-D-WT).

Teledyne FLIR makes available optional I/O cables as described in I/O Mating Connector Sources. Contact Sales for availability and pricing.

Table 31: Samtec 10-Pin Connector Pin Assignment

Pin Number	Cable Color	Signal	Direction	Definition
1	Black	AUX_GND	—	Camera Power - Ground
2	Red	AUX_PWR	—	Camera Power - DC +10V to +36V
3	Brown	GPI_CMN_GND	—	General Input Common ground
4	Orange	GPO_CMN_PWR	—	General Output Common power
5	Yellow	GPI_P0	In	General Purpose Input 0
6	Green	GPO_P0	Out	General Purpose Output 0
7	Blue	Reserved	—	Reserved
8	Violet	Reserved	—	Reserved
9	Gray	Reserved	—	Reserved
10	White / Transparent	GND_CHASSIS		Camera Chassis

## Input Signal Electrical Specifications

### External Input Block Diagram

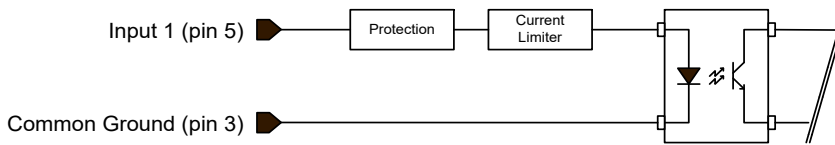

### External Input Details

- Opto-coupled with internal current limit.
- Single input trigger threshold level:  $<0.8V$ =Logical LOW,  $>2.4V$ =Logical HIGH.
- Used as trigger acquisition event, counter or timestamp event, or integration control.
- User programmable debounce time from 0 to 16000  $\mu s$  in 1 $\mu s$  steps.
- Source signal requirements:
  - Single-ended driver meeting 3V, 12V, or 24V standards (see table below)
  - Differential signal driver

### External Input DC Characteristics

Operating Specification	Minimum	Maximum
Input Voltage	+3 V	+36 V
Input Current	4.9 mA	12 mA
Input logic Low		0.8 V
Input logic High	2.4 V	

### Absolute Maximum Range before Possible Device Failure

Absolute Ratings	Minimum	Maximum
Input Voltage	-36 Volts	+36 Volts

### External Input AC Timing Characteristics

Conditions	Description	Min	Unit
Input Pulse 0V – 3V	Input Pulse width High	100	ns
	Input Pulse width Low	50	ns
	Max Frequency	4.5	MHz
Input Pulse 0V – 5V	Input Pulse width High	140	ns
	Input Pulse width Low	30	ns
	Max Frequency	3.5	MHz
Input Pulse 0V – 12V	Input Pulse width High	250	ns
	Input Pulse width Low	20	ns
	Max Frequency	1.9	MHz
Input Pulse 0V – 24V	Input Pulse width High	360	ns
	Input Pulse width Low	30	ns
	Max Frequency	1.5	MHz

### External Input: Using TTL/LVTTL Drivers

- External Input maximum current is limited by the A68/A38 circuits to a maximum of 12mA.

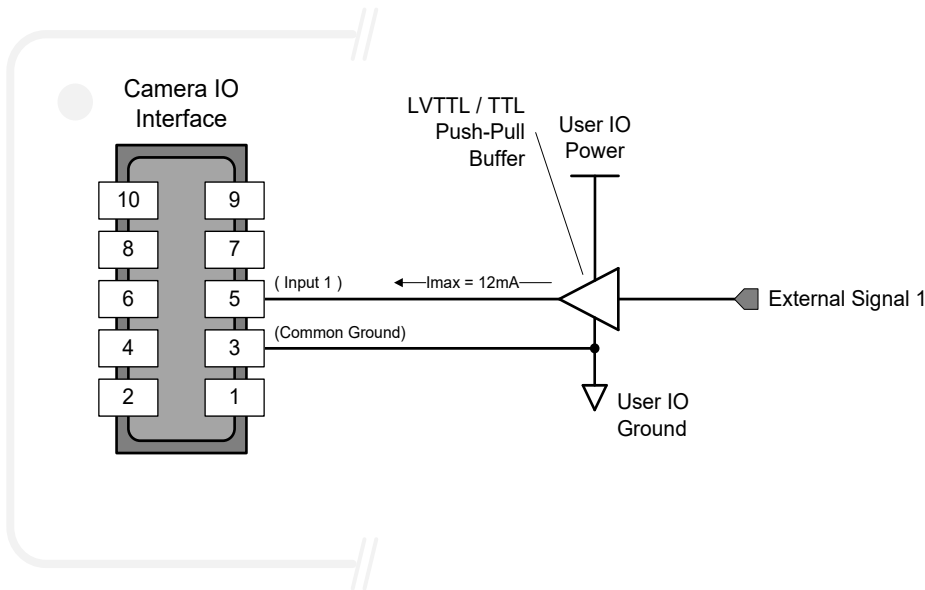

Note: When using a TTL / LVTTL buffer check the high input voltage is greater than 2.4V on the input of the A68/A38.

### External Input: Using Common Collector NPN Drivers

External Input maximum current is limited by the A68/A38 circuits to a maximum of 12mA.

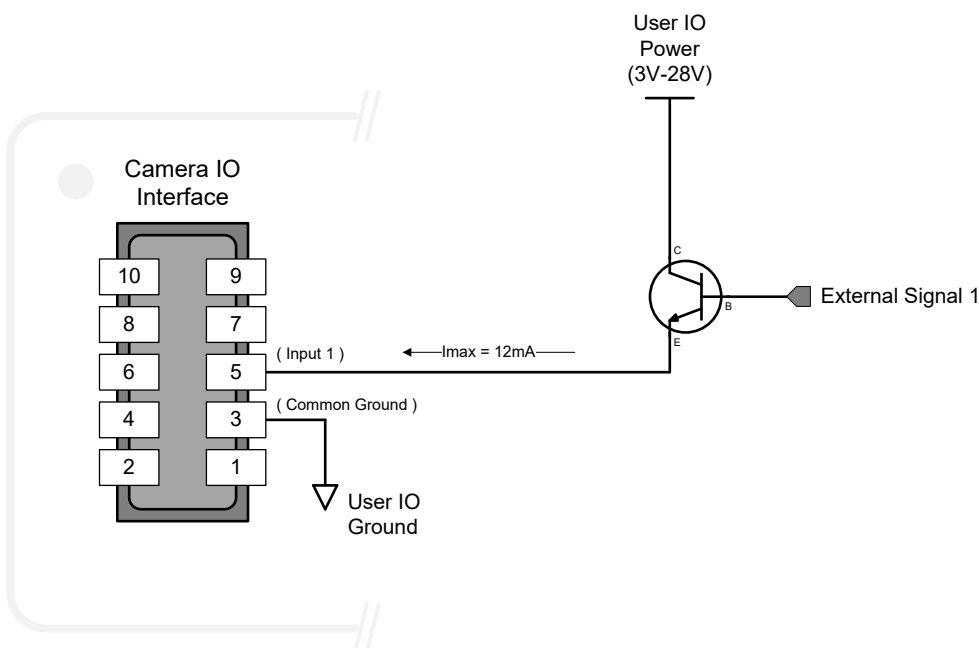

### External Input: Using Common Emitter NPN Driver

External Input maximum current is limited by the A68/A38 circuits to a maximum of 12mA.

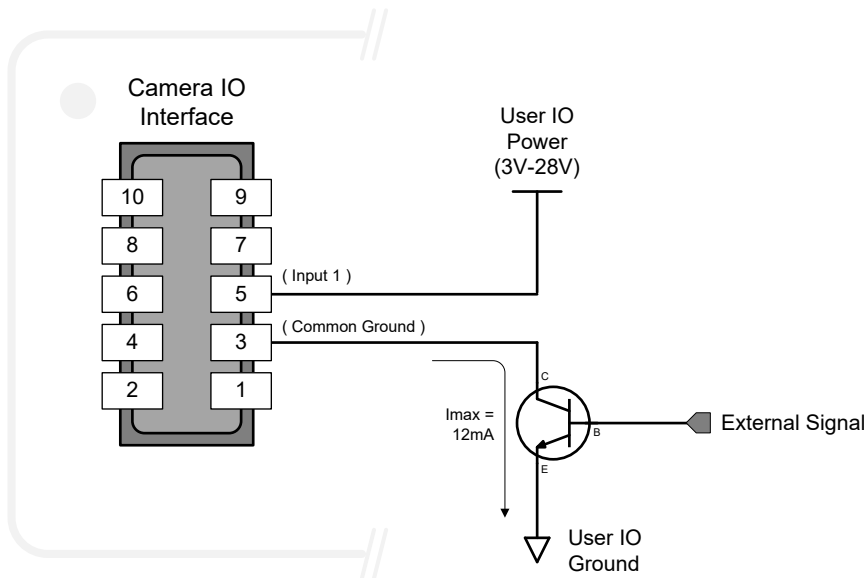

### External Input: Using a Balanced Driver

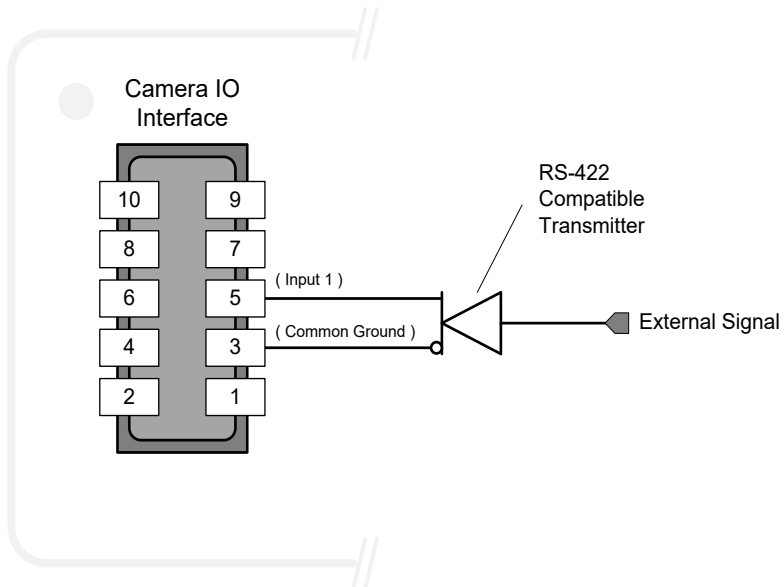

## Power over Ethernet (PoE) Support

- The FLIR A68/A38 series requires a PoE Class 0 or Class 1 (or greater) power source for the network if not using a separate external power source connected to pins 1 & 2 of the camera's I/O Connector.
- To use PoE, the camera network setup requires a powered computer NIC supporting PoE, or a PoE capable Ethernet switch, or an Ethernet power injector.



**Important:** Connect power via the I/O connector or PoE, but not both. Although FLIR A68/A38 series has protection, differences in ground levels may cause operational issues or electrical faults.

When using PoE, the camera's I/O pin 1 (Camera Power – Ground) and pin 2 (Camera Power- Power) must not be connected.

If both supplies are connected and active, the FLIR A68/A38 series will use the I/O power supply connector. But as stated, ground differences may cause camera faults or failure.

## Output Signals Electrical Specifications

### Opto-Coupled External Output (Pin 6)

#### Block Diagram

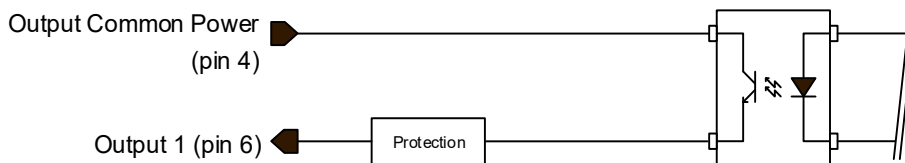

#### External Output Details and DC Characteristics

- Programmable output mode such as strobe, event notification, etc (see [LineSource](#) feature)
- Outputs are open on power-up with the default factory settings
- A software reset will not reset the outputs to the open state if the outputs are closed
- A user setup configured to load on boot will not reset the outputs to the open state if the outputs are closed
- No output signal glitch on power-up or polarity reversal

#### Typical Operating Common Power Voltage Range: +3V to 28Vdc at 24mA

- **Maximum** Common Power Voltage Range:  $\pm 30\text{Vdc}$
- **Maximum** Output Current: 24mA

### External Output AC Timing Characteristics

The graphic below defines the test conditions used to measure the A68/A38 external output AC characteristics, as detailed in the table that follows.

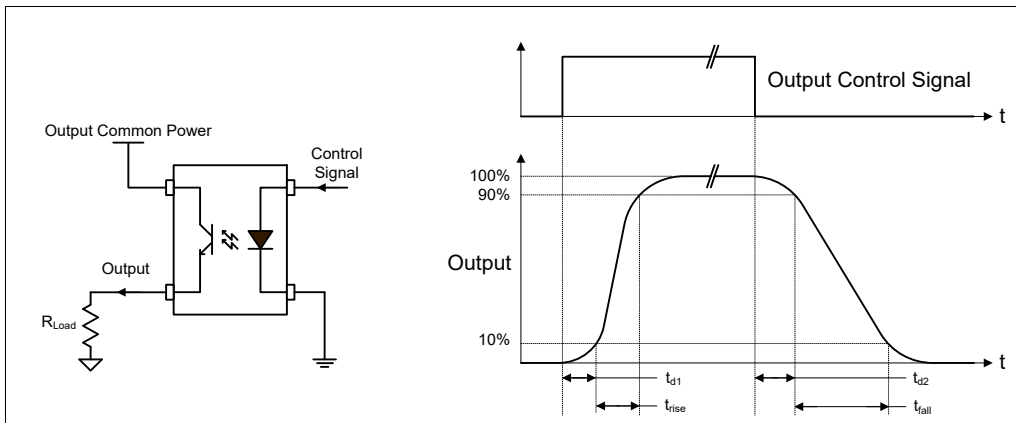

### Opto-coupled Output (Pin 6): AC Characteristics

Note: All measurements subject to some rounding.

Output Common Power	Output Current	Output Voltage	$t_{d1}$ ( $\mu$ s) Leading Delay	$t_{rise}$ ( $\mu$ s) Rise Time	$t_{d2}$ ( $\mu$ s) Trailing Delay	$t_{fall}$ ( $\mu$ s) Fall Time
3V	8 mA	1.55V	1.5 $\mu$ s	8.96 $\mu$ s	4.5 $\mu$ s	10 $\mu$ s
	16 mA	1.25V	2.1 $\mu$ s	8.58 $\mu$ s	8.3 $\mu$ s	8.6 $\mu$ s
5V	8 mA	3.32V	1.6 $\mu$ s	4.6 $\mu$ s	12.6 $\mu$ s	10.7 $\mu$ s
	16 mA	3.1V	1.7 $\mu$ s	6.3 $\mu$ s	10.0 $\mu$ s	8.5 $\mu$ s
	21 mA	2.9V	1.8 $\mu$ s	7.2 $\mu$ s	8.8 $\mu$ s	7.8 $\mu$ s
12V	8 mA	10.2V	1.9 $\mu$ s	2.8 $\mu$ s	15.9 $\mu$ s	13.6 $\mu$ s
	16 mA	10.0V	2.0 $\mu$ s	3.9 $\mu$ s	11.0 $\mu$ s	9.9 $\mu$ s
	24 mA	9.5V	1.9 $\mu$ s	3.0 $\mu$ s	9.7 $\mu$ s	6.3 $\mu$ s
24V	8 mA	22.5V	2.2 $\mu$ s	3.0 $\mu$ s	18.5 $\mu$ s	13.6 $\mu$ s
	16 mA	21.65V	2.2 $\mu$ s	2.6 $\mu$ s	12.8 $\mu$ s	11.0 $\mu$ s
	24 mA	21.3V	2.2 $\mu$ s	2.7 $\mu$ s	11.4 $\mu$ s	8.1 $\mu$ s

### External Outputs: Using External TTL/LVTTL Drivers

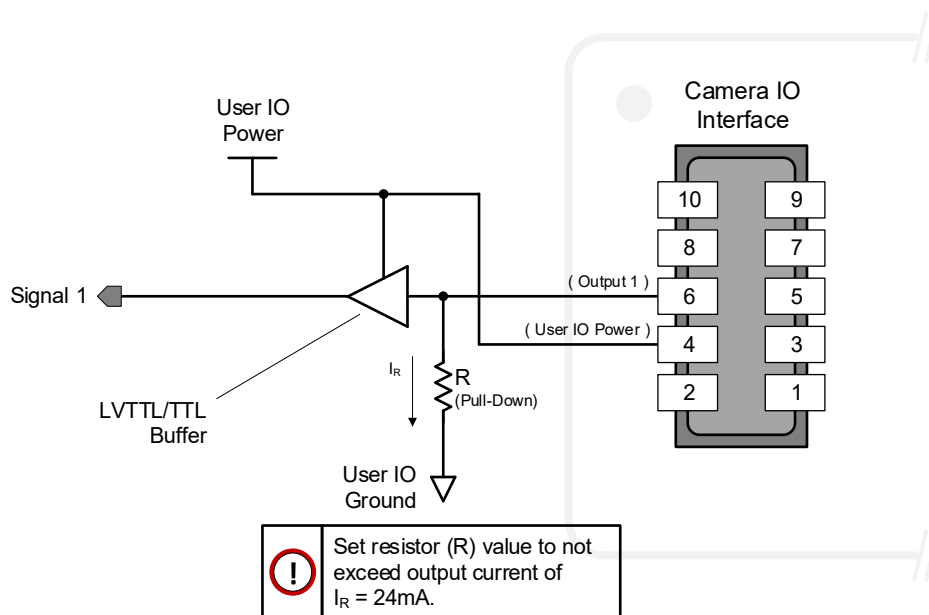

### External Outputs: Using External LED Indicator

One external LED can be connected in the Common Cathode configuration.

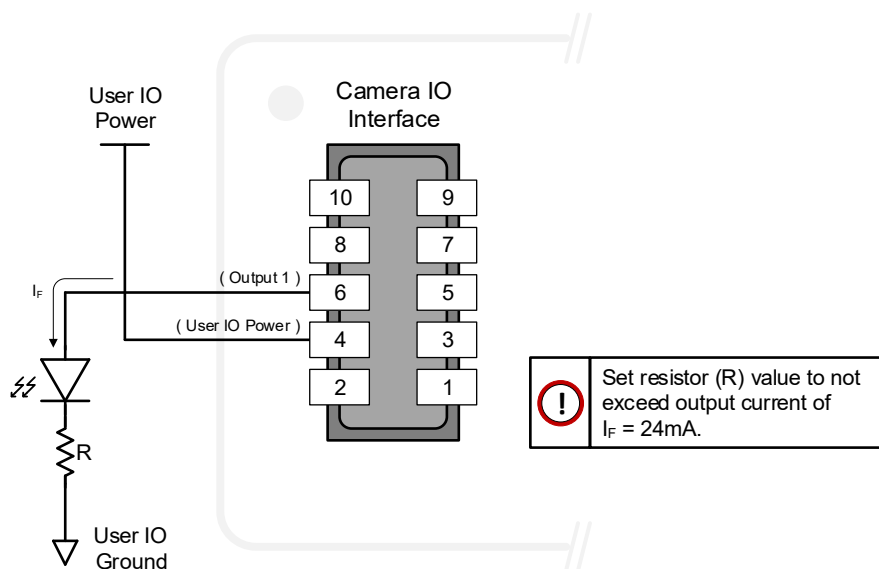

Alternatively one external LED can be connected in the Common Anode configuration.

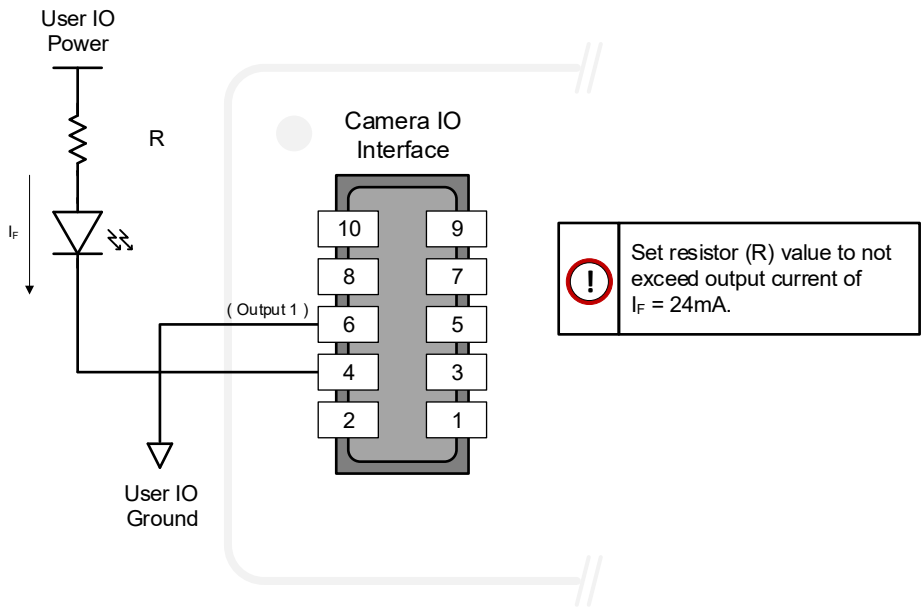

**Using Outputs to drive other A68/A38 Inputs**

- A synchronization method where one A68/A38 camera signals other A68/A38 cameras.
- Note: One A68/A38 output can drive a maximum of three A68/A38 inputs, as illustrated below.

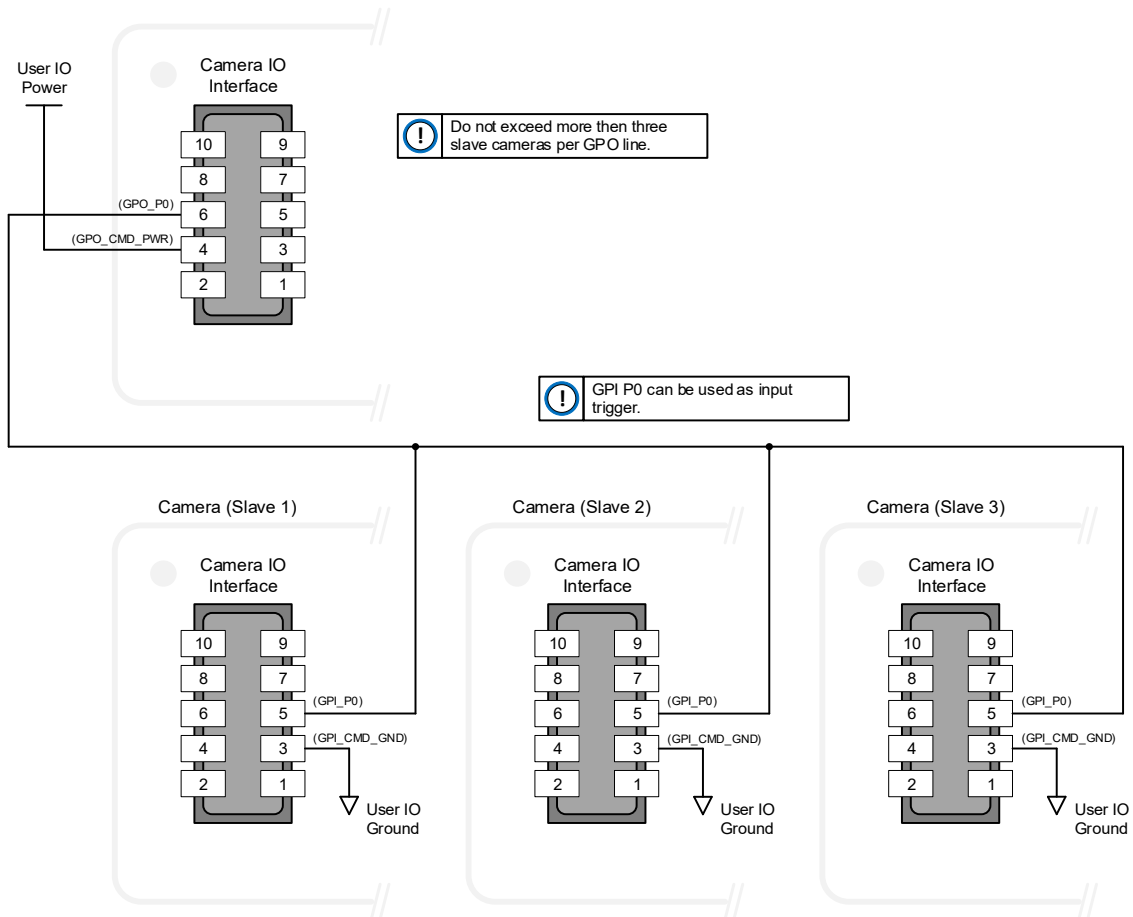



---

## Additional Reference Information

### I/O Mating Connector Sources

Teledyne FLIR provides optional I/O cable assemblies for A68/A38. Users wishing to build their I/O cabling by starting from available cable packages should consider these popular assemblies described below. Contact Sales for pricing and delivery.

Users also may order cable assembly quantities directly from [Components Express](#). In such cases use the manufacturer's part number shown on the cable assembly engineering drawing.

For users wishing to build their own custom I/O cabling, the following product information is provided to expedite your cable solutions.

MFG	Part #	Description	Data Sheet
Samtec	SFSD-05-[WG]-G-[AL]-DR-[E20] <i>WG : Wire Gauge</i> <i>AL : Assembled Length</i> <i>E20 : End 2 Option</i>	Discrete Cable Assembly	<a href="http://www.samtec.com/technical-specifications/Default.aspx?SeriesMaster=SFSD">www.samtec.com/technical-specifications/Default.aspx?SeriesMaster=SFSD</a>
Samtec	ISDF-05-D ISDF-05-D-M	Discrete Connector	<a href="http://www.samtec.com/technical-specifications/Default.aspx?SeriesMaster=ISDF">www.samtec.com/technical-specifications/Default.aspx?SeriesMaster=ISDF</a>
<b>ISDF-05-D-M Connector Availability On-Line</b>			
North-America (specific country can be selected)		<a href="http://www.newark.com/samtec/isd2-05-d-m/connector-housing-10pos-2mm/dp/84T0350">http://www.newark.com/samtec/isd2-05-d-m/connector-housing-10pos-2mm/dp/84T0350</a>	
Europe (specific country can be selected)		<a href="http://uk.farnell.com/samtec/isdf-05-d-m/receptacle-1-27mm-crimp-10way/dp/2308547?ost=ISDF-05-D-M">http://uk.farnell.com/samtec/isdf-05-d-m/receptacle-1-27mm-crimp-10way/dp/2308547?ost=ISDF-05-D-M</a>	
Asia-Pacific (specific country can be selected)		<a href="http://sg.element14.com/samtec/isdf-05-d-m/receptacle-1-27mm-crimp-10way/dp/2308547?ost=ISDF-05-D-M">http://sg.element14.com/samtec/isdf-05-d-m/receptacle-1-27mm-crimp-10way/dp/2308547?ost=ISDF-05-D-M</a>	

### Components Express Cable Assemblies

<b>For information contact:</b>	Components Express, Inc. (CEI) 10330 Argonne Woods Drive, Suite 100 Woodridge, IL 60517-4995 Phone: 630-257-0605 / 800.578.6695 (outside Illinois) Fax: 630-257-0603 <a href="http://www.componentsexpress.com/">http://www.componentsexpress.com/</a>
---------------------------------	---

---

## Ruggedized RJ45 Ethernet Cables

Components Express Inc. has available industrial RJ45 CAT6 cables that on one end have a molded shroud assembly with top/bottom thumbscrews, while the other end is a standard RJ45 (one example shown below). These cables are recommended when A68/A38 is installed in a high vibration environment. All A68/38 series camera versions support this secure Ethernet cable. Review their catalog for all available versions of vertical thumbscrew RJ45 cable sets.



Figure 62: Ruggedized RJ45 Ethernet cable with Thumbscrews

<b>All cables made in U.S.A. – all cables RoHS compliant.</b>	CAT6 certified (tested for near end / far end crosstalk and return loss). IGE-3M (3meters) IGE-10M (10meters) IGE-25M (25meters) IGE-50M (50meters) IGE-100M (100meters)
---	--

---

## Sensor Handling Instructions

This section reviews proper procedures for handling, cleaning, or storing the A68/A38 camera. Specifically, the A68/A38 sensor needs to be kept clean and away from static discharge to maintain design performance.



**WARNING:** Teledyne FLIR does not recommend removing the lens; keeping the lens in place removes the possibility of exposing the sensor to contaminants that require cleaning (FLIR A68/A38 series cameras ship with lenses attached).

If it is necessary to remove the lens:

- Always keep the camera vertical, front plate facing down.
- Do not touch the internal mechanical shutter; any physical contact to the shutter may render it unusable.

### Cleaning the Sensor Window

Dust can obscure pixels, producing dark patches on the sensor response. Dust can normally be removed by blowing the window surface using a compressed air blower, unless the dust particles are being held by an electrostatic charge, in which case either an ionized air blower is necessary.

The sensor window is part of the optical path and should be handled like other optical components, with extreme care. If the sensor window needs cleaning:

- Always keep the camera vertical, front plate facing down.
- Ensure the shutter is in the open position.
- Use compressed air (30psi maximum) to blow off loose particles. This step alone is usually sufficient to clean the sensor window. Avoid moving or shaking the compressed air container and use short bursts of air while moving the camera in the air stream. Agitating the container will cause condensation to form in the air stream. Long air bursts will chill the sensor window causing more condensation. Condensation, even when left to dry naturally, will deposit more particles on the sensor.



**WARNING:** Never physically touch the sensor or internal shutter; use only compressed air for cleaning. Compressed air must not exceed 30psi or damage may occur to the internal shutter.

- Ensure the lens and interface thread are dust-free before replacing the lens.

### Electrostatic Discharge and the Sensor

Cameras sensors containing integrated electronics are susceptible to damage from electrostatic discharge (ESD). Electrostatic charge introduced to the sensor window surface can induce charge buildup on the underside of the window that cannot be readily dissipated by the vacuum in the sensor package cavity. With charge buildup, problems such as higher image lag or a highly non-uniform response may occur. The charge normally dissipates within 24 hours and the sensor returns to normal operation.

# Declarations of Conformity

Copies of the Declarations of Conformity documents (for example, EU, FCC & ICES Supplier and Material Composition Product Declaration) are available on the product page on the [Teledyne FLIR website](#) or by request.

## **FCC Statement of Conformance**

This equipment complies with Part 15 of the FCC rules. Operation is subject to the following conditions:

1. The product may not cause harmful interference; and
2. The product must accept any interference received, including interference that may cause undesired operation.

## ***FCC Class A Product***

This equipment has been tested and found to comply with the limits for a Class A digital device, pursuant to part 15 of the FCC Rules. These limits are designed to provide reasonable protection against harmful interference when the equipment is operated in a commercial environment. This equipment generates, uses, and can radiate radio frequency energy and, if not installed and used in accordance with the instruction manual, may cause harmful interference to radio communications. Operation of this equipment in a residential area is likely to cause harmful interference in which case the user will be required to correct the interference at his own expense.

Changes or modifications not expressly approved by the party responsible for compliance could void the user's authority to operate the equipment.

This equipment is intended to be a component of a larger industrial system.

## **EU and UKCA Declaration of Conformity**

Teledyne DALSA declares that this product complies with applicable standards and regulations.

Changes or modifications not expressly approved by the party responsible for compliance could void the user's authority to operate the equipment.

This product is intended to be a component of a larger system and must be installed as per instructions to ensure compliance.

# Troubleshooting

---

## Overview

In rare cases an installation may fail or there are problems in controlling and using the A68/A38 camera. This section highlights issues or conditions which may cause installation problems and additionally provides information on computers and network adapters which have caused problems with A68/A38. Emphasis is on the user to perform diagnostics with the tools provided and methods are described to correct the problem.

---

## Quick Recovery Guide

Typically, the Sopera LT default configuration detects GenICam cameras automatically, but it may be required to use the Network Configuration Tool (distributed with Sopera LT as part of the Sopera Network Imaging Package) to configure the Network Interface Card (NIC).

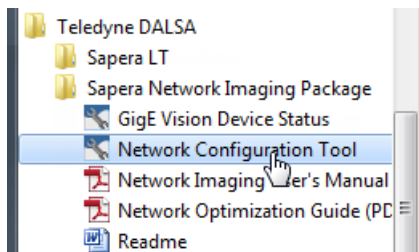

The Network Configuration Tool displays the available NICs:

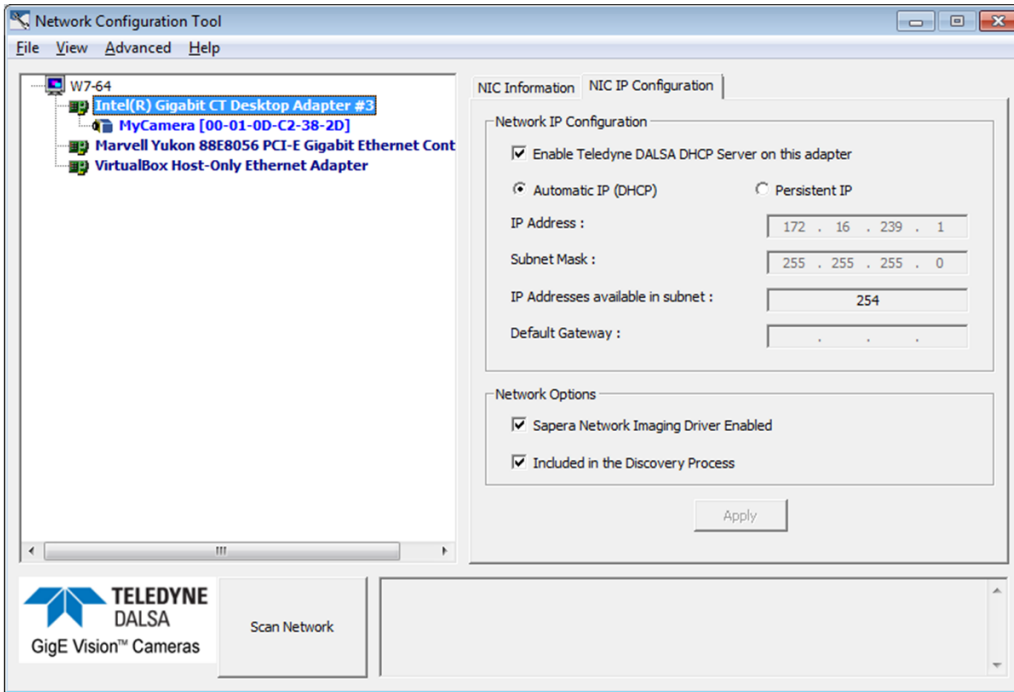

Click on the NIC where the A68/A38 camera is connected, and make sure the following options are enabled / selected:

- Enable Teledyne DALSA DHCP Server;
- Automatic IP (DHCP);
- Sopera Network Imaging Driver Enabled;
- Included in the Discovery Process.

The camera should then be visible to the host computer's software. When placing the mouse cursor over the GigE Vision Device Status in the system tray, the number of available devices should be shown:



Double-click the camera icon to show the GigE Vision Device Status window. The A68/A38 camera should be listed:

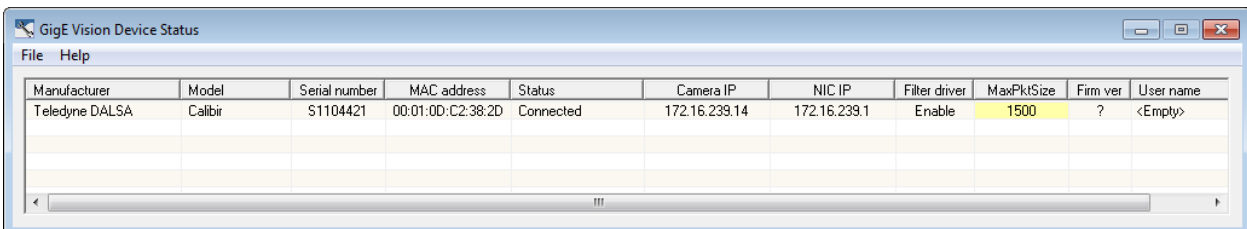

If the camera is not listed, refer to the other information in the Troubleshooting section for possible solutions.

---

## General Troubleshooting for FLIR A68/A38 Series

The following sections outline general troubleshooting information that applies to all A68/38 Series cameras.

### Error Log File

Refer to the Error Log File section for information on retrieving the error log file.

### Power Failure During a Firmware Update—Now What?

Don't panic! There is far greater chance that the host computer OS is damaged during a power failure than any permanent problems with the A68/A38. The firmware update procedure was designed to be robust and handle power interruptions. When electrical power returns and the host computer system has started, follow this procedure.

- Connect power to the A68/A38. The A68/A38 processor knows that the firmware update failed.
- The A68/A38 will boot with the previous version of firmware and will operate normally.
- Perform the firmware update procedure (see File Access Control Category) again.

### Power supply problems:

- If the A68/A38 status LED is off, the power supply is not connected or faulty. Verify the power supply voltage.

### Camera is functional, but image has no contents

- Aim the A68/A38 at an object with a temperature considerably higher/lower from that of the ambient environment.
- Using CamExpert, set the [PixelFormat](#) to 8-bits. The camera should then generate well-contrasted images.

Using CamExpert set the A68/A38 to output its Internal Pattern Generator. This step is typically done for any camera installation to quickly verify the A68/A38 and its software package. See the Internal Test Pattern Generator section for information on using CamExpert to select internal patterns from A68/A38.

---



## FLIR A68/A38 Series Troubleshooting

The following sections contain troubleshooting information specific to the FLIR A68/A38 series camera related to its network interface.

### GigE Server Status

The GigE Server status provides visual information on possible A68/A38 problems. The three states are shown in the following table. Descriptions of possible conditions causing an installation or operational problem follow. Note that even a A68/A38 installation with no networking issue may still require optimization to perform to specification.

*Table 32: GigE Server Tray Icon States*

	Device Not Available	Device IP Error	Device Available
<b>GigE Server Tray Icon:</b>			
Note: It will take a few seconds for the GigE Server to refresh its state after any change.	A red X will remain over the GigE server tray icon when the A68/A38 device is not found. This indicates a network issue where there is no communication with A68/A38. <b><i>Or in the simplest case,</i></b> the A68/A38 is not connected.	The GigE server tray icon shows a warning when a device is connected but there is some type of IP error.	The GigE server tray icon when the A68/A38 device is found. The A68/A38 has obtained an IP address and there are no network issues. Optimization may still be required to maximize performance.



## Problem Type Summary

A68/A38 problems are either installation types where the A68/A38 is not found on the network or setup errors where the A68/A38 device is found but not controllable. Additionally a A68/A38 may be properly installed but network optimization is required for maximum performance. The following links jump to various topics in this troubleshooting section.



### Device Not Available

A red X over the GigE server tray icon indicates that the A68/A38 device is not found. This indicates either a major camera fault or condition such as disconnected power, or a network issue where there is no communication.

- Refer to the Quick Start Guide and Camera Connection Setup sections to verify required installation steps.
- Refer to the Teledyne DALSA Network Imaging manual to review networking details.
- In multiple NIC systems where the NIC for the A68/A38 is using LLA mode, ensure that no other NIC is in or switches to LLA mode. It is preferable that the Teledyne DALSA DHCP server is enabled on the NIC used with the A68/A38 instead of using LLA mode, which prevents errors associated with multiple NIC ports.
- Verify that your NIC is running the latest driver available from the manufacturer.



### Device IP Error

The GigE server tray icon shows a warning with IP errors. Review the following topics on network IP problems to identify and correct the condition.

Please refer to the Teledyne DALSA Network Imaging Package manual for information on the Teledyne DALSA Network Configuration tool and network optimization for GigE Vision cameras and devices.

### Multiple Camera Issues

- When using multiple cameras with a computer with multiple NIC ports, confirm each A68/A38 has been assigned an IP address by checking the GigE server.
- To reduce network traffic in configured problem free systems, use the Network Configuration tool to stop camera discovery broadcasts. Refer to the Teledyne DALSA Network Imaging manual.
- When using multiple cameras connected to an VLAN Ethernet switch, confirm that all cameras are on the same subnet setup on that switch. See the Teledyne DALSA Network Imaging package manual for more information. .
- If a A68/A38 camera installed with other GigE Vision cameras cannot connect properly with the NIC or has acquisition timeout errors, there may be a conflict with the third-party camera's filter driver. In some cases, third-party filter drivers modify the NIC properties such that the Teledyne DALSA Sopera Network Imaging Driver does not install. Verify such a case by uninstalling the third-party driver and installing the A68/A38 package again.
- Verify that your NIC is running the latest driver available from the manufacturer.



## **Device Available but with Operational Issues**

A properly installed A68/A38 with no network issues may still not perform optimally. Operational issues concerning cabling, Ethernet switches, multiple cameras, and camera exposure are discussed in the following sections:

### **Always Important**

- Power Failure During a Firmware Update–Now What?
- Cabling and Communication Problems:
- See Preventing Operational Faults due to ESD to avoid random packet loss, random camera resets, and random loss of Ethernet connections.

### **No Timeout messages**

- I can use CamExpert to grab but the image is corrupted with bad data. See Grab has Random Bad Data or Noise.
- I can use CamExpert to grab (with no error message) but there is no image (display window stays black). See Acquisition Error without Timeout Messages.
- I can use CamExpert to grab (with no error message) but the frame rate is lower than expected. See Camera acquisition is good but frame rate is lower than expected.
- There is no image and the frame rate is lower than expected.  
See Camera is functional but frame rate is lower than expected.
- There is no image but the frame rate is as expected.  
See Camera is functional, but image has no contents.

## Acquisition Error without Timeout Messages

Streaming video problems range from total loss of image data to occasional loss of random video data packets. The following section describes conditions identified by Teledyne engineering while working with A68/A38 in various computers and setups. See the Teledyne DALSA Network Imaging manual for information on network optimizations.

### *Grab has Random Bad Data or Noise*

The problem is seen as random noise and missing sections of video data from the acquisition. All configuration parameters seem correct and the Ethernet cable is secure. The following image shows an example of this type of bad acquisition while testing a A68/A38 installation with CamExpert.



Figure 63: Random Bad Data or Noise Example

- Some marginal NIC boards or ports can cause problems with packet transfers. Try alternative NIC adapters.

Review other reasons for such acquisition errors as described in the **Teledyne DALSA Network Imaging Module for Sopera LT** manual.

### *Camera is functional but frame rate is lower than expected*

- Verify Ethernet link speed. If the LAN connection is limited to 100 Mbps, the A68/A38 frame rate maximum will be limited once the internal buffers are filled. See the Teledyne DALSA Network Imaging manual for information on network optimizations.

### ***Camera acquisition is good but frame rate is lower than expected***

- While running CamExpert and grabbing in free-run mode at the maximum frame rate, start the **Sapera Monitor** tool from the Sapera Tools installed with Sapera.
- Make sure the **Memory Overflow** event monitor is enabled.
- Continue grabbing from the A68/A38 at maximum frame rate. If any memory overflow events are counted, then the A68/A38 internal buffer could not be transmitted on time and was discarded. Such a condition may occur with large frame color or high frame rate A68/A38 cameras.
- Note that the Sapera CamExpert tool has limits to the maximum frame rate possible due to CamExpert generating an interrupt for each acquired frame. The Sapera Grab Demo may be better suited for testing at higher frame rates.
- Verify that network parameters are optimal as described in the Teledyne DALSA Network Imaging Module manual. Ensure the host computer is not executing other network intensive tasks. Try a different Gigabit NIC.
- Note that a changed acquisition frame rate becomes active only when the acquisition is stopped and then restarted.

### **Cabling and Communication Problems:**

- Use a shielded cable where the connector shell electrically connects the A68/A38 chassis to the power supply earth ground.
- Check that the Ethernet cable is clipped both to the A68/A38 and the NIC or switch on the other end.
- Verify the Ethernet cabling. Poor cables will cause connections to auto-configure at lower speeds. Use a secured Ethernet cable when the A68/A38 is in a high vibration environment. See Ruggedized RJ45 Ethernet Cables.
- Check the Ethernet status LEDs on the NIC used with the camera. The Link Status indicator is on and the activity LED should flash with network messages.
- Verify that the Ethernet cable is CAT5e or CAT6. This is very important with long cable lengths.
- When using very long cables, up to the maximum specified length of 100m for gigabit Ethernet, different NIC hardware and EMI conditions can affect the quality of transmission.
- Minimum recommended Ethernet cable length is 3 feet (1 meter).
- Use the Log Viewer tool (see point below) to check on packet resend conditions. Run the Sapera Log Viewer: **Start•Programs•Teledyne DALSA•Sapera LT•Tools•Log Viewer**. Start the A68/A38 acquisition program, such as CamExpert. There should not be any "packet resend" messages, else this indicates a control or video transmission problem due to poor connections or extremely high EMI environments.

## Verifying Network Parameters

Teledyne DALSA provides the Network Configuration tool to verify and configure network devices and the A68/A38 network parameters. See section Network Configuration Tool of the Teledyne DALSA Network Imaging manual, if there were any problems with the automatic A68/A38 software installation.

### *Before Contacting Technical Support*

Carefully review the issues described in this Troubleshooting section. To aid Teledyne FLIR personnel when support is required, the following should be included with the request for support.

- From the Start menu, go to **Programs • Teledyne Dalsa • Sapera LT • Tools** and run the **Log Viewer** program. From its File menu click on **Save Messages** to generate a log text file.
- Report the version of A68/A38 firmware and Sapera version used.

---

## Internal Shutter Problems

The A68/A38 internal shutter is a small mechanical device that when activated to change position requires a certain amount of electrical power above the nominal operating level. In some cases, if inadequate power is available the transition from open to closed state may be interrupted. As a preventative measure to avoid electrical faults ensure that the camera is adequately powered according to the [Electrical Interface](#) specifications.

Other issues due to the mechanical nature of the shutter may also be at fault, however, the camera is tolerant to a certain level of shock and vibration (refer to the A68/A38 Series EMI, Shock and Vibration Certifications).

The shutter movement from the open to closed position is as follows:

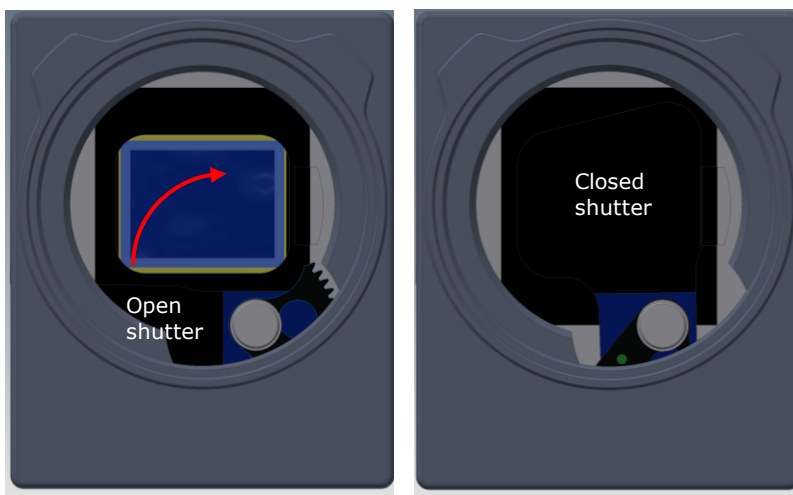

To analyze the shutter position during FPN correction, the average non-uniformity is calculated over 3 zones in the image. The Last FPN Average Error features, available in the [FPN Correction](#) category, display results immediately following an FPN correction.

Last FPN Average Error, Zone A	364
Last FPN Average Error, Zone B	322
Last FPN Average Error, Zone C	357

Zone A, the full image, is used to detect a halfway-stuck shutter (near 45 degree angle). Zone B, a 100-pixel wide section in the top-left corner, detects a barely open shutter. Zone C, a 100-pixel height section in the bottom-right corner, detects a nearly closed shutter. Higher than normal values in these zones indicate a shutter problem has occurred.

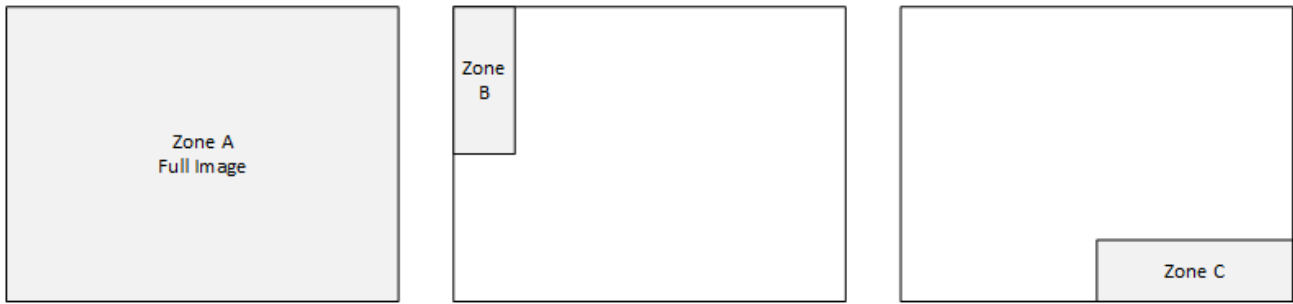

Thresholds for each of these zones can be specified; when performing an FPN correction if the values exceed any of these thresholds, the A68/A38 assumes an internal shutter error has occurred and attempts to close the shutter again.

Max FPN Average Error, Zone A	100000
Max FPN Average Error, Zone B	100000
Max FPN Average Error, Zone C	100000

The A68/A38 provides shutter error count features that indicate if a shutter failure occurred during FPN calibration. During calibration if a shutter failure occurs it is registered as Shutter Single Error Count and the camera will attempt to activate the shutter again; if the second attempt fails, the FPN calibration is aborted and the failure is registered in the Shutter Double Error count.

Shutter Activation Count	57
Shutter Single Error Count	0
Shutter Double Error Count	0

The Shutter Activation Count returns the total number of times the internal shutter has been activated during the camera lifetime; the count is persistent and is not reset after a reboot or if the camera is powered off.

**Website**

<http://www.flir.com>

**Customer support**

<http://support.flir.com>

**Copyright**

© 2022, FLIR Systems, Inc. All rights reserved worldwide.

**Disclaimer**

Specifications subject to change without further notice. Models and accessories subject to regional market considerations. License procedures may apply. Products described herein may be subject to US Export Regulations. Please refer to [exportquestions@flir.com](mailto:exportquestions@flir.com) with any questions.